



**COMMERCIAL
RESIDENTIAL
LIGHTING**



*New Standard
in Lighting!*

**PRODUCT CATALOG
2025/2**





SINCE 1999

ASD LIGHTING CORP

ASD Lighting Corp has become one of the leading LED lighting brands in the United States for commercial and residential applications.



QUALITY

For the production of ASD Luminaires we carefully choose the highest quality components to ensure efficiency and longevity.



LOGISTICS

We are constantly improving our warehouse system so that delivery and storage of ASD products is not only profitable but fast and convenient.





COMMERCIAL LIGHTING

HIGH BAYS

- 10 LED LINEAR HIGH BAY WITH Q-BASE
NEOX series
ASD-WHB5B-NEOX 
- 12 LED LINEAR HIGH BAY WITH Q-BASE
STANDARD series
ASD-WHB5B-ST 
- 14 LED LINEAR BEAM ANGLE ADJUSTABLE
HIGH BAY WITH Q-BASE STANDARD series
ASD-WHB5B-ST-BA 
- 15 SMART RGBW FULL SURFACE
LINEAR HIGH BAY
ASD-WHB7-RGBW 
- 16 LED LINEAR NARROW HIGH BAY
WITH Q-BASE STANDARD series
ASD-NHB-ST 
- 18 LED UFO HIGH BAY WITH Q-BASE
NEOX series
ASD-UHB2A-NEOX 
- 20 LED UFO HIGH BAY WITH Q-BASE
STANDARD series
ASD-UHB2A-ST 
- 22 LED UFO BEAM ANGLE ADJUSTABLE
HIGH BAY WITH Q-BASE STANDARD series
ASD-UHB2A-ST-BA 
- 23 LED UFO HIGH BAY SLIM
ASD-UHS 



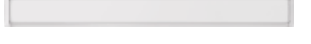

NSF LIGHTING

- 24 NSF LED UFO HIGH BAY WITH Q-BASE
ASD-UFS-PRO 
- 25 NSF LED LINEAR HIGH BAY WITH Q-BASE
ASD-WFS-ST 

LINEAR LIGHTS

- 26 LED SEAMLESS VAPOR PROOF FIXTURE
ASD-LVP25M 
- 28 LED STRIPLIGHT FIXTURE WITH Q-BASE
ASD-LSF8 
- 30 LED STRIPLIGHT FIXTURE
ASD-LSF5 
- 32 LED STRIPLIGHT FIXTURE HIGH LUMENS
ASD-LSF8 
- 33 LED WRAP FIXTURE
ASD-WRL 
- 33 LED WRAP FIXTURE
ASD-WRL2 

LED PANELS

- 34 LED BACK-LIT PANEL
ASD-BLP 
- 36 LED BACK-LIT PANEL HIGH LUMENS
ASD-BLP 
- 37 LED BACK-LIT PANEL PRO series
10 YEAR WARRANTY
ASD-BLP-PRO 
- 38 SMART LED BACK-LIT PANEL
ASD-BLP-SM 

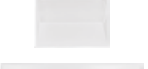
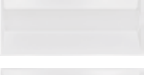
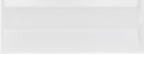

LED TROFFERS

- 39 LED TROFFER RETROFIT KIT
ASD-LTRK 
- 40 LED TROFFER LIGHT
ASD-LTR 
- 41 LED TROFFER LIGHT HIGH LUMENS
ASD-LTR 



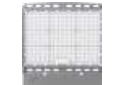

DOWNLIGHTS

- 42 LED TRIMLESS DOWNLIGHT
ASD-CD-T 
- 44 LED TRIMLESS DOWNLIGHT GIMBAL
ASD-CD-TG 
- 45 LED TRIMLESS COMBO DOWNLIGHT
ASD-TCS 
- 46 LED DOWNLIGHT 1 & 2 INCH
ASD-CD-P 
- 47 LED DOWNLIGHT 2 INCH WITH WALL
WASH TRIM
ASD-CD-PWR 
- 48 LED ROUND COMMERCIAL DOWNLIGHT
ASD-CDL7 
- 50 LED COMMERCIAL DOWNLIGHT
ASD-CDL7R, ASD-CDL7S 



AREA LIGHTS

- 52 LED AREA LIGHT WITH Q-BASE
NEOX series
ASD-LSB5B-NEOX 
- 54 LED AREA LIGHT WITH Q-BASE
PRO series
ASD-LSB5B-PRO 
- 56 LED ROUND AREA LIGHT
WITH Q-BASE
ASD-LSB5R-PRO 







SPORT LIGHTS

- 60 LED SPORT LIGHT
ASD-SPFL7 
- 61 LED SPORT LIGHT UP-LIGHT SERIES
ASD-SPFL7UP 
- 62 LED SPORT LIGHT WITH DMX
ASD-SPFL7-DMX 
- 62 LED SPORT LIGHT WITH DMX & RGBW
ASD-SPFL7-RGBW-DMX 
- 63 LED SPORT LIGHT
ASD-SPFL8 

CANOPIES

- 64 LED SLIM CANOPY
ASD-CAN05 
- 65 LED LOW-PROFILE CANOPY
WITH Q-BASE
ASD-CAN07A 
- 66 LED SQUARE EDGE-LIT CANOPY
WITH Q-BASE
ASD-CAN09S 

WALLPACKS

- 67 LED SECURITY WALLPACK
ASD-SWP 
- 68 LED TRADITIONAL WALLPACK
ASD-WLP01 
- 69 LED ADJUSTABLE CUTOFF WALLPACK
ASD-WLP02A 
- 70 LED FULL CUTOFF WALLPACK
ASD-WLP03 
- 71 LED SLIM WALLPACK
ASD-WLS 
- 72 LED ROUND WALLPACK
ASD-WLR, ASD-WLR-UD 



SECURITY LIGHTS

- 73 VAPOR JELLY JAR RGBCW LIGHT
ASD-VTJ 
- 74 LED DUAL-HEAD SECURITY LIGHTS
ASD-SFL2 
- 75 LED DUAL-HEAD SECURITY LIGHTS
WITH MOTION SENSOR
ASD-SFL 
- 75 LED DUAL-HEAD SECURITY LIGHTS
WITH CAMERA
ASD-SFL-SC 

SENSORS

- 76 Q-BASE MOTION SENSOR
ASD-M2MW, ASD-08MW, ASD-M22IR 
- 77 MOTION SENSOR WITH 3-PIN BASE
ASD-09IR, ASD-S10IR, ASD-09IR50, ASD-09MW 

BATTERIES

- 78 EMERGENCY BATTERY BACK-UP KIT
BLD-RM, ASD-EMB, BLD-GM60R-HV 
- 79 EMERGENCY BATTERY BACK-UP KIT
ASD-EMK, BLD-HM, ASD-EMA15 

RESIDENTIAL LIGHTING



FLUSHMOUNT LIGHTS

- 82 LED FLUSHMOUNT LOFT
ASD-LOFT-FM 
- 83 LED FLUSHMOUNT LOFT WITH RGBW
ASD-LOFT-FM-RGBW 
- 84 LED DOUBLE RING FLUSHMOUNT
ASD-LFMDR 
- 85 LED DOUBLE RING FLUSHMOUNT WITH RGBW
ASD-LFMDR-RGBW 
- 86 LED OVAL DOUBLE RING FLUSHMOUNT
ASD-LFMOV 
- 87 LED OVAL EDGE LIT PANEL
ASD-MPO 
- 88 LED EDGE LIT PANEL
ASD-MP 
- 90 LED DISK LIGHT
ASD-LDS 

CANLESS RECESSED LIGHTS

- 92 LED ROUND WAFER
ASD-JBR 
- 92 LED SQUARE WAFER
ASD-JBS 
- 93 LED WAFER ROUND WITH RGBW
ASD-JBR-RGBW 
- 94 LED ROUND WAFER WITH NIGHT LIGHT
ASD-JBR-NL 
- 95 LED ROUND CANLESS DOWNLIGHT GIMBAL
ASD-JBR-GB 
- 96 LED ROUND ROUND WAFER BAFFLE TRIM 100-277V
ASD-JBRB-MV 
- 97 LED ROUND WAFER FIRE RATED
ASD-JFR 
- 98 LED WAFER WITH DEEP BAFFLE TRIM
ASD-JBR-DB 
- 99 NEW CONSTRUCTION MOUNTING PLATE
ASD-MPL 



RETROFIT DOWNLIGHTS

- 100 LED ROUND DOWNLIGHT RETROFIT KIT
ASD-LRKR 
- 100 LED SQUARE DOWNLIGHT RETROFIT KIT
ASD-LRKS 
- 101 LED DOWNLIGHT RETROFIT KIT GIMBAL
ASD-LRK-GBR, ASD-LRK-GB 



LED VANITY LIGHTS

- 102 LED VANITY LINEAR LOFT
ASD-LOFT-VF 
- 103 LED VANITY LINEAR LIGHT
ASD-LVF21 
- 104 LED VANITY LINEAR LIGHT
ASD-LVF22 
- 105 LED VANITY LINEAR LIGHT
ASD-LVF23 
- 106 LED VANITY LIGHT
ASD-LVF24M 



VANITY AND PENDANT LIGHTS

- 107 VANITY LIGHT & MINI-PENDANT
ASD-VF44, ASD-MP44 
- 108 VANITY LIGHT & MINI-PENDANT
ASD-VF45, ASD-MP45 





INDOOR WALL SCONCES

- 109 LED WALL SCONCE LOFT
ASD-LOFT-WS 
- 110 LED WALL SCONCE
ASD-LWS-11 
- 111 LED WALL SCONCE
ASD-LWS-12 





UNDER CABINET LIGHTS

- 112 LED UNDER CABINET LINEAR
ASD-UCL 
- 113 LED UNDER CABINET SWIVEL
ASD-UCS 
- 114 LED UNDER CABINET BULLNOSE
ASD-UBN 







EMERGENCY LIGHT

- 115 LED DOUBLE SIDE EXIT SIGN RED
ASD-ESD 
- 116 LED EDGE LIT TRANSPARENT EXIT SIGN RED
ASD-EXT 
- 117 LED EXIT SIGN RED WITH EMERGENCY LIGHTS
ASD-EXL 
- 118 LED EMERGENCY LIGHTS
ASD-EML-2RL, ASD-EML-2SL 

OUTDOOR LED LIGHTS

- 119 LED STEP LIGHT WITH RGBW
ASD-STLA-RGBW 
- 120 LED STEP LIGHT
ASD-LSTL 
- 122 LED SWIVEL HARDSCAPE LIGHT
ASD-HSL 
- 123 LED SWIVEL HARDSCAPE LIGHT WITH RGBW
ASD-HSL-RGBW 



OUTDOOR LED WALL LIGHTS

- 124 LED OUTDOOR WALL SCONCE
ASD-OLWS-21 
- 125 LED OUTDOOR WALL SCONCE WITH GRID
ASD-OLWS-21GR 
- 126 LED OUTDOOR WALL SCONCE WITH RGBW
ASD-OLWS-21-RGBW 
- 127 LED OUTDOOR WALL SCONCE
ASD-OLWS-22 
- 128 LED OUTDOOR WALL SCONCE
ASD-OLWS-23 
- 129 LED OUTDOOR WALL SCONCE WITH RGBW
ASD-OLWS-23-RGBW 
- 130 LED OUTDOOR WALL SCONCE
ASD-LWS26S 
- 131 LED OUTDOOR WALL SCONCE WITH RGBW
ASD-LWS26-RGBW 

OUTDOOR LED WALL LIGHTS

- 132 LED OUTDOOR WALL SCONCE
ASD-LWS28S 
- 133 LED OUTDOOR WALL SCONCE WITH RGBW
ASD-LWS28S-RGBW 
- 134 LED OUTDOOR WALL SCONCE WITH WIDE ACRYLIC
ASD-LWS27A 
- 135 LED OUTDOOR WALL SCONCE WITH WIDE ACRYLIC & RGBW
ASD-LWS27A-RGBW 
- 136 LED OUTDOOR NARROW WALL SCONCE
ASD-LWS27N 
- 137 LED OUTDOOR NARROW WALL SCONCE WITH RGBW
ASD-LWS27N-RGBW 
- 138 LED OUTDOOR WALL SCONCE WITH CENTER LIGHT
ASD-LWS27C 
- 139 LED OUTDOOR WALL SCONCE WITH CENTER LIGHT & RGBW
ASD-LWS27C-RGBW 
- 140 LED OUTDOOR BACKLIGHT WALL SCONCE
ASD-LWS27B 
- 141 LED ROUND OUTDOOR WALL CYLINDER WITH RGBW
ASD-LCLR2-RGBW 
- 142 LED OUTDOOR WALL CYLINDER
ASD-LCL 
- 143 LED OUTDOOR WALL CYLINDER WITH DECORATIVE RINGS
ASD-LCL-B 

OUTDOOR BULB LIGHTS

- 144 BULB OUTDOOR WALL CYLINDER
ASD-OCL-A 
- 144 BULB OUTDOOR WALL CYLINDER WITH DECORATIVE RINGS
ASD-OCL-B 
- 145 BULB OUTDOOR BOLLARD WITH DECORATIVE RING
ASD-BLC 



COMMERCIAL LIGHTING



LED LINEAR HIGH BAY WITH Q-BASE NEOX series

ASD-WHB5B-NEOX

200
lm/W
SERIES
NEOX

200lm/W
EXTREME EFFICIENCY

Q-BASE

COLOR AND POWER
SELECTABLE

IK10
IMPACT RESISTANT

**PRODUCT
SIZE**
14-35 inch

POWER ADJUSTABLE
100W, 160W, 220W,
320W, 500W

**COLOR
SELECTABLE**
3500K-5000K

120-277V
voltage

6kV
Surge
protection

200-480V
voltage



**BUILT-IN
Q-BASE**

MICROWAVE OR PIR
MOTION SENSOR

REMOTE CONTROL
Sold separately



**BATTERY
BACK-UP KIT**

MORE THAN 9000lm
IN EMERGENCY MODE FOR 90min

AUTOMATIC SELF-TESTING

OVERCHARGE
AND OVER-DISCHARGE PROTECTION



ASD-EMK 20W OR 30W

**COLOR AND POWER
SELECTABLE**

3CCT COLOR SELECTABLE

3PA POWER ADJUSTABLE



INCLUDED

SUSPENDED MOUNT KIT



PENDANT MOUNT BRACKET



SURFACE MOUNT BRACKET

LED LINEAR HIGH BAY WITH Q-BASE STANDARD series

ASD-WHB5B-ST



170lm/W
EXTREME EFFICIENCY

Q-BASE

COLOR AND POWER
SELECTABLE

IK10
IMPACT RESISTANT

**PRODUCT
SIZE**
14-41 inch

POWER ADJUSTABLE
100W, 160W, 220W,
320W, 500W, 750W

**COLOR
SELECTABLE**
3500K-5000K

120-277V
voltage

6kV
Surge
protection

200-480V
voltage

**BUILT-IN
Q-BASE**

MICROWAVE OR PIR
MOTION SENSOR

REMOTE CONTROL
Sold separately



**BATTERY
BACK-UP**

MORE THAN 8100lm
IN EMERGENCY MODE FOR 90min

AUTOMATIC SELF-TESTING

OVERCHARGE
AND OVER-DISCHARGE PROTECTION



BUILT-IN BATTERY BACK-UP 40W



BATTERY BACK-UP KIT UP TO 30W

**COLOR AND POWER
SELECTABLE**

3CCT COLOR SELECTABLE

3PA POWER ADJUSTABLE



INCLUDED

SUSPENDED MOUNT KIT



PENDANT MOUNT BRACKET



SURFACE MOUNT BRACKET

LED LINEAR BEAM ANGLE ADJUSTABLE HIGH BAY with Q-BASE STANDARD series

ASD-WHB5B-ST-BA

170
lm/W
STANDARD SERIES

BEAM ANGLE, COLOR & POWER SELECTABLE

- 3BA** 45°, 60°, 90° BEAM ANGLE ADJUSTABLE
- 3CCT** COLOR SELECTABLE
- 3PA** POWER ADJUSTABLE

BATTERY BACK-UP KIT

- MORE THAN 4700lm IN EMERGENCY MODE FOR 90min
- AUTOMATIC SELF-TESTING

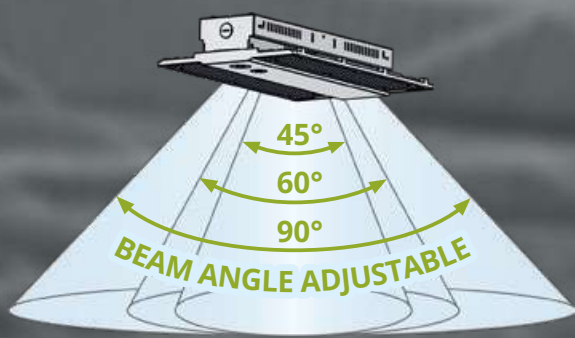

- BEAM ANGLE ADJUSTABLE**
- 170lm/W HIGH EFFICIENCY**

- DIE-CAST ALUMINIUM HOUSING**
- COLOR AND POWER SELECTABLE**

- 120-277V** voltage
- 6kV** Surge protection

PRODUCT SIZE
24", 33"

POWER ADJUSTABLE
220W, 320W

3CCT COLOR SELECTABLE
3500K-5000K



SMART RGBW FULL SURFACE LINEAR HIGH BAY

ASD-WHB7-RGBW



FULL SURFACE LENS

CONTROLLED BY SMART APP ON YOUR SMARTPHONE



RGBW DESIGN WITH 16.7 MILLION COLORS

DIE-CAST ALUMINIUM HOUSING



120-277V voltage

PRODUCT SIZE
24", 33"

AVAILABLE POWER
160W, 220W

3CCT COLOR SELECTABLE
3500K-5000K + RGBW

HIGH BAYS

i 147 INFO PAGE



15

14

HIGH BAYS

i 147 INFO PAGE

LED LINEAR NARROW HIGH BAY WITH Q-BASE STANDARD series

ASD-NHB-ST

170
lm/W
STANDARD
SERIES



NARROW DESIGN

170lm/W
HIGH EFFICIENCY

DIE-CAST ALUMINIUM HOUSING

COLOR AND POWER SELECTABLE

120-277V
voltage

6kV
Surge
protection

PRODUCT SIZE
30", 33"

POWER ADJUSTABLE
160W, 220W, 320W

COLOR SELECTABLE
3500K-5000K

BUILT-IN Q-BASE

INFRARED MOTION SENSOR

REMOTE CONTROL
Sold separately



BUILT-IN BATTERY BACK-UP
ASD-NHB-ST-EM

MORE THAN 6800lm
IN EMERGENCY MODE FOR 90min

AUTOMATIC SELF-TESTING

OVERCHARGE
AND OVER-DISCHARGE PROTECTION

40W
BATTERY BACK-UP POWER



COLOR AND POWER SELECTABLE

3CCT COLOR SELECTABLE

3PA POWER ADJUSTABLE



LED UFO HIGH BAY WITH Q-BASE NEOX series

ASD-UHB2A-NEOX

200
lm/W
SERIES
NEOX

200lm/W
EXTREME EFFICIENCY

IK08 PROTECTION
AGAINST IMPACTS

white

IP69K RATED, ALLOWS
HIGH PRESSURE WASHING

COLOR AND POWER
SELECTABLE

black

POWER ADJUSTABLE
150W, 200W, 240W,
300W, 500W

COLOR SELECTABLE
3000K-5000K

120-277V
voltage

6kV
Surge
protection

200-480V
voltage

**BUILT-IN
Q-BASE**

MICROWAVE OR PIR
MOTION SENSOR

REMOTE CONTROL
Sold separately



**BATTERY
BACK-UP KIT**

MORE THAN 8000lm
IN EMERGENCY MODE FOR 90min

AUTOMATIC SELF-TESTING

OVERCHARGE
AND OVER-DISCHARGE PROTECTION

UP TO 60W
BATTERY BACK-UP POWER

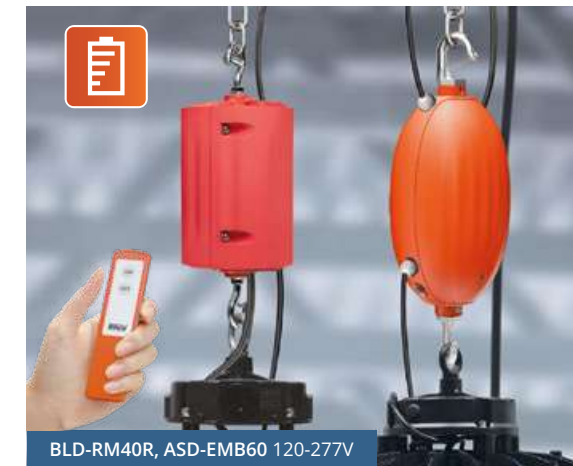

BLD-RM40R, ASD-EMB60 120-277V



BLD-GM60R-HV 277-480V

**COLOR AND POWER
SELECTABLE**

3CCT COLOR SELECTABLE

3PA POWER ADJUSTABLE

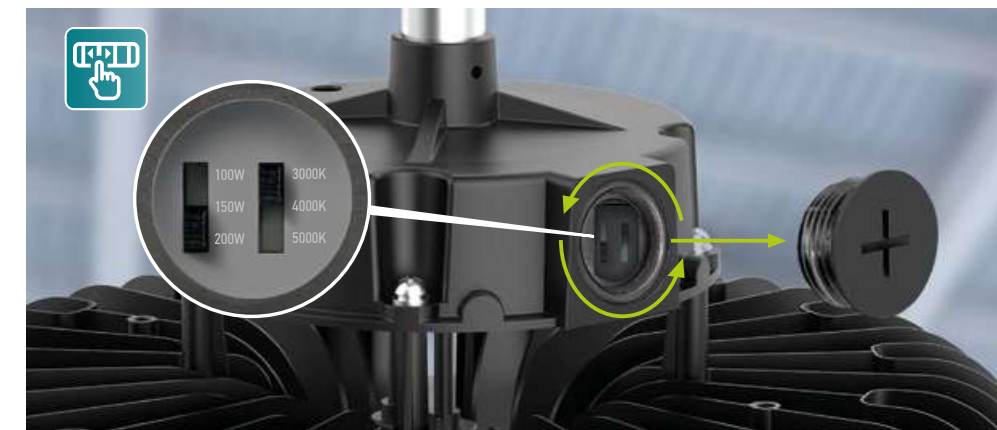

SCREW-BOLT HOOK
AND SPRING HOOK



PENDANT MOUNT
BRACKET



PENDANT MOUNT
BRACKET WITH J-BOX



SURFACE MOUNT
BRACKET

LED UFO HIGH BAY WITH Q-BASE STANDARD series

ASD-UHB2A-ST

170
lm/W
STANDARD
SERIES

UP TO
1000
WATTS



170lm/W
EXTREME EFFICIENCY



IK08 PROTECTION
AGAINST IMPACTS

white



IP69K RATED, ALLOWS
HIGH PRESSURE WASHING



COLOR AND POWER
SELECTABLE

black

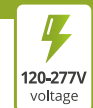

120-277V
voltage



6kV
Surge
protection



200-480V
voltage



POWER ADJUSTABLE

150W, 200W, 240W, 300W,
500W, 750W, 1000W



COLOR SELECTABLE

3000K-5000K



BUILT-IN
Q-BASE



MICROWAVE OR PIR
MOTION SENSOR



REMOTE CONTROL
Sold separately



BATTERY
BACK-UP KIT



MORE THAN 6800lm
IN EMERGENCY MODE FOR 90min



AUTOMATIC SELF-TESTING



OVERCHARGE
AND OVER-DISCHARGE PROTECTION



UP TO 60W
BATTERY BACK-UP POWER

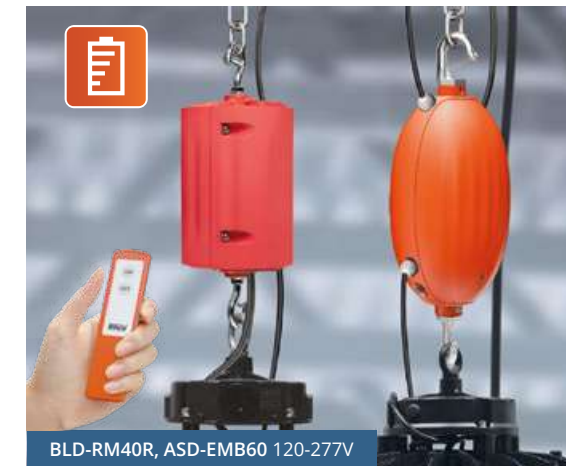

BLD-RM40R, ASD-EMB60 120-277V



BLD-GM60R-HV 277-480V



COLOR AND POWER
SELECTABLE



COLOR SELECTABLE



POWER ADJUSTABLE

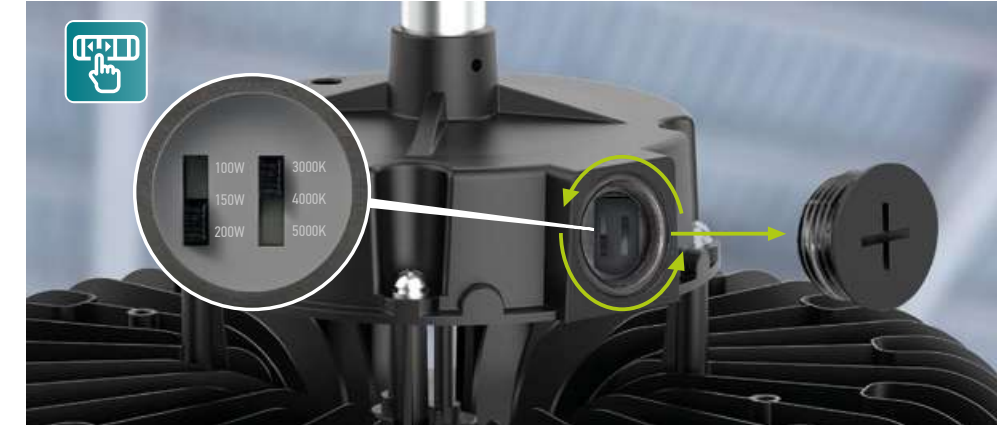

SCREW-BOLT HOOK
AND SPRING HOOK



PENDANT MOUNT
BRACKET



PENDANT MOUNT
BRACKET WITH J-BOX



SURFACE MOUNT
BRACKET

LED UFO BEAM ANGLE ADJUSTABLE HIGH BAY with Q-BASE STANDARD series

ASD-UHB2A-ST-BA

BEAM ANGLE, COLOR & POWER SELECTABLE

- 3BA** 60°, 90°, 110° BEAM ANGLE ADJUSTABLE
- 3CCT** COLOR SELECTABLE
- 3PA** POWER ADJUSTABLE

BATTERY BACK-UP KIT

- MORE THAN 6000lm IN EMERGENCY MODE FOR 90min
- AUTOMATIC SELF-TESTING

**170
lm/W**
STANDARD SERIES



BEAM ANGLE ADJUSTABLE

170lm/W HIGH EFFICIENCY

IP69K RATED, ALLOWS HIGH PRESSURE WASHING

COLOR AND POWER SELECTABLE

120-277V
voltage

6kV
Surge protection

W **POWER ADJUSTABLE**
200W, 240W

3CCT **COLOR SELECTABLE**
3500K-5000K



LED UFO HIGH BAY SLIM

ASD-UHS

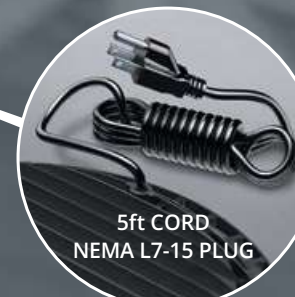

100-277V

IP65 AND WET LOCATIONS RATED

5FT CORD WITH PLUG

4kV **4kV SURGE PROTECTION**

120-277V
voltage

4kV
Surge protection

W **AVAILABLE POWER**
100W, 150W, 200W

K **COLOR TEMPERATURE**
5000K



NSF LED UFO HIGH BAY WITH Q-BASE

ASD-UFS-PRO



160
lm/W
EFFICIENCY

COLOR AND POWER SELECTABLE

- 3CCT COLOR SELECTABLE
- 3PA POWER ADJUSTABLE

BUILT-IN Q-BASE

- MICROWAVE OR PIR MOTION SENSOR
- REMOTE CONTROL Sold separately

NSF FOOD GRADE FIXTURE. NSF CERTIFIED

COLOR AND POWER SELECTABLE

CORROSION-RESISTANT ALUMINUM HOUSING WITH SUS316 STAINLESS STEEL SCREWS

IP69K RATED, ALLOWS HIGH PRESSURE WASHING

W POWER ADJUSTABLE
200W, 300W

3CCT COLOR SELECTABLE
3000K-5000K

120-277V voltage
6kV Surge protection
200-480V voltage

NSF LED LINEAR HIGH BAY WITH Q-BASE

ASD-WFS-ST



170
lm/W
EFFICIENCY

BUILT-IN Q-BASE

- MICROWAVE OR PIR MOTION SENSOR
- REMOTE CONTROL Sold separately

COLOR AND POWER SELECTABLE

- 3CCT COLOR SELECTABLE
- 3PA POWER ADJUSTABLE

NSF FOOD GRADE FIXTURE. NSF CERTIFIED

IP69K RATED, ALLOWS HIGH PRESSURE WASHING

170lm/W HIGH EFFICIENCY

CORROSION-RESISTANT ALUMINUM HOUSING

PRODUCT SIZE
20", 27"

W POWER ADJUSTABLE
160W, 240W

3CCT COLOR SELECTABLE
3500K-5000K

120-277V voltage

LED SEAMLESS VAPOR PROOF FIXTURE

ASD-LVP2SM



COLOR AND POWER SELECTABLE

- 3 CCT COLOR SELECTABLE
- 3 PA POWER ADJUSTABLE

IMPACT RESISTANT POLYCARBONATE BODY

COLOR AND POWER SELECTABLE

SEAMLESS DESIGN

STAINLESS CLIPS FOR EASY INSTALLATION ARE INCLUDED

PRODUCT SIZE
2ft, 4ft, 8ft

POWER ADJUSTABLE
28W, 56W, 120W

COLOR SELECTABLE
3500K-5000K

120-277V voltage

6kV Surge protection

IP66

BUILT-IN MOTION SENSOR
ASD-LVP2SM-MS

QUICK ADJUSTMENTS BY REMOTE CONTROL

INSTALLATION HEIGHT UP TO 13FT

REMOTE CONTROL Sold separately



BUILT-IN BATTERY BACK-UP
ASD-LVP2SM-EM

MORE THAN 2300lm IN EMERGENCY MODE FOR 90min

AUTOMATIC SELF-TESTING

OVERCHARGE AND OVER-DISCHARGE PROTECTION

UP TO 20W BATTERY BACK-UP POWER



DAISY CHAIN

EASY TO CONNECT MULTIPLE FIXTURES

BUILT-IN JUNCTION BOX



LED STRIPLIGHT FIXTURE

ASD-LSF5



**140
lm/W**
EFFICIENCY

**COLOR AND POWER
SELECTABLE**

3CCT COLOR SELECTABLE

3PA POWER ADJUSTABLE

- DURABLE COMMERCIAL GRADE HOUSING
RESISTANT TO RUST AND IMPACT
- ANTI-GLARE PMMA LENS
WITH EVEN LIGHT DISTRIBUTION

- COLOR AND POWER
SELECTABLE
- LINKABLE DESIGN

120-277V
voltage

**PRODUCT
SIZE**
2ft, 4ft, 8ft

**POWER
ADJUSTABLE**
28W, 44W, 90W

**COLOR
SELECTABLE**
3500K-5000K

**BUILT-IN
MOTION SENSOR**
ASD-LSF5-MS

- STAIRWELL AND PASSAGWAY
LUMINAIRES CLASSIFICATION
- ADJUSTABLE SENSOR
- BI-LEVEL MICROWAVE MOTION
SENSOR WITH REMOTE CONTROL

**BUILT-IN
BATTERY BACK-UP**
ASD-LSF5-EM

- MORE THAN 2400lm
IN EMERGENCY MODE FOR 90min
- AUTOMATIC SELF-TESTING
- OVERCHARGE
AND OVER-DISCHARGE PROTECTION

**BUILT-IN MOTION SENSOR
& BATTERY BACK-UP**
ASD-LSF5-EM-MS

- STAIRWELL AND PASSAGWAY
LUMINAIRES CLASSIFICATION
- BI-LEVEL MICROWAVE MOTION
SENSOR WITH REMOTE CONTROL
- MORE THAN 2000lm
IN EMERGENCY MODE FOR 90min
- AUTOMATIC SELF-TESTING



BATTERY BACK-UP POWER UP TO 15W



BATTERY BACK-UP POWER 12W



INCLUDED



SUSPENDED MOUNT V-HOOK SURFACE MOUNTING



CONNECTION BRACKET



WIRE GUARD

LED STRIPLIGHT FIXTURE WITH Q-BASE

ASD-LSF8

150
lm/W
EFFICIENCY

COLOR AND POWER SELECTABLE

3CCT COLOR SELECTABLE

3PA POWER ADJUSTABLE



Q-BASE



LINKABLE DESIGN

white



DURABLE COMMERCIAL GRADE HOUSING
RESISTANT TO RUST AND IMPACT



COLOR AND POWER
SELECTABLE

black



PRODUCT
SIZE

2ft, 4ft, 8ft



POWER
ADJUSTABLE

25W, 40W, 80W



COLOR
SELECTABLE

3500K-5000K



120-277V
voltage



6kV
Surge
protection



200-480V
voltage



BUILT-IN
Q-BASE
ASD-LSF8-QB



STAIRWELL AND PASSAGWAY
LUMINAIRES CLASSIFICATION



INFRARED MOTION SENSOR



REMOTE CONTROL
Sold separately



BUILT-IN
BATTERY BACK-UP
ASD-LSF8-EM



MORE THAN 2500lm
IN EMERGENCY MODE FOR 90min



AUTOMATIC SELF-TESTING



OVERCHARGE
AND OVER-DISCHARGE PROTECTION



BATTERY BACK-UP POWER UP TO 15W



BUILT-IN Q-BASE
& BATTERY BACK-UP
ASD-LSF8-QB-EM



STAIRWELL AND PASSAGWAY
LUMINAIRES CLASSIFICATION



INFRARED MOTION SENSOR
WITH REMOTE CONTROL



MORE THAN 2500lm
IN EMERGENCY MODE FOR 90min



AUTOMATIC SELF-TESTING



BATTERY BACK-UP POWER UP TO 15W

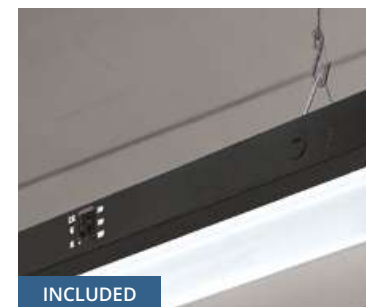

INCLUDED

SUSPENDED MOUNTING



INCLUDED

SURFACE MOUNTING



CONNECTION BRACKET



WIRE GUARD

LED STRIPLIGHT FIXTURE HIGH LUMENS

ASD-LSF8



UP TO **10,000 LUMENS**

COLOR AND POWER SELECTABLE

3CCT COLOR SELECTABLE

3PA POWER ADJUSTABLE

145lm/W
EXTREME EFFICIENCY

LINKABLE DESIGN

DURABLE COMMERCIAL GRADE HOUSING
RESISTANT TO RUST AND IMPACT

COLOR AND POWER SELECTABLE

PRODUCT SIZE
4ft, 8ft

POWER ADJUSTABLE
70W, 150W

3CCT COLOR SELECTABLE
3500K-5000K

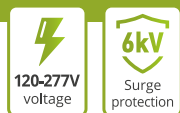

LED WRAP FIXTURE



ASD-WRL

BUILT-IN BATTERY BACK-UP

MORE THAN 1200lm
IN EMERGENCY MODE FOR 90min

AUTOMATIC
SELF-TESTING

UP TO **150 lm/W**
EFFICIENCY

COLOR AND POWER SELECTABLE

3CCT COLOR SELECTABLE

3PA POWER ADJUSTABLE

DURABLE COMMERCIAL GRADE HOUSING
RESISTANT TO RUST AND IMPACT

COLOR AND POWER SELECTABLE

ANTI-GLARE PMMA LENS
WITH EVEN LIGHT DISTRIBUTION

0-10V DIMMABLE

PRODUCT SIZES
4ft

POWER ADJUSTABLE
45W, 48W

3CCT COLOR SELECTABLE
3500K-5000K



LED BACK-LIT PANEL

ASD-BLP

125
lm/W
EFFICIENCY

COLOR AND POWER SELECTABLE

- 3CCT COLOR SELECTABLE
- 3PA POWER ADJUSTABLE



MAGNETIC Q-BASE



ANTI-GLARE PC LENS WITH EVEN LIGHT DISTRIBUTION



DURABLE COMMERCIAL GRADE HOUSING RESISTANT TO RUST AND IMPACT



COLOR AND POWER SELECTABLE

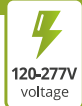

PRODUCT SIZE
1x4, 2x2, 2x4



POWER ADJUSTABLE
30W, 40W, 50W



COLOR SELECTABLE
3500K-5000K



BUILT-IN MOTION SENSOR
ASD-BLP-MS



MICROWAVE MOTION SENSOR



QUICK ADJUSTMENTS BY REMOTE CONTROL



REMOTE CONTROL
Sold separately



BUILT-IN Q-BASE & BATTERY BACK-UP
ASD-BLP-QB-EM



MICROWAVE MOTION SENSOR WITH REMOTE CONTROL



MORE THAN 1200lm IN EMERGENCY MODE FOR 90min



AUTOMATIC SELF-TESTING



OVERCHARGE AND OVER-DISCHARGE PROTECTION



8W BATTERY BACK-UP POWER



RECESSED MOUNTING



SUSPENDED MOUNT KIT



SURFACE MOUNT KIT

LED BACK-LIT PANEL HIGH LUMENS

ASD-BLP

10,000
LUMENS

- COLOR AND POWER SELECTABLE
- 5CCT** COLOR SELECTABLE
- 4PA** POWER ADJUSTABLE

150lm/W
EXTREME EFFICIENCY

ANTI-GLARE PC LENS
WITH EVEN LIGHT DISTRIBUTION

DURABLE COMMERCIAL GRADE HOUSING
RESISTANT TO RUST AND IMPACT

COLOR AND POWER
SELECTABLE

LED BACK-LIT PANEL PRO series 10 YEAR WARRANTY

ASD-BLP-PRO

10
YEAR
WARRANTY

- COLOR AND POWER SELECTABLE
- 3CCT** COLOR SELECTABLE
- 3PA** POWER ADJUSTABLE

10 YEAR WARRANTY

DURABLE COMMERCIAL GRADE HOUSING
RESISTANT TO RUST AND IMPACT

COLOR AND POWER
SELECTABLE

MOUNTING OPTIONS: RECESSED,
SUSPENDED, AND SURFACE

120-277V
voltage

PRODUCT SIZE
2x4

POWER ADJUSTABLE
67W

5CCT COLOR SELECTABLE
3000K-6500K

120-277V
voltage

PRODUCT SIZE
2x4

POWER ADJUSTABLE
40W

3CCT COLOR SELECTABLE
3500K-5000K

SMART RGBW LED BACK-LIT PANEL

ASD-BLP-SM

RGBW RGBW

RGBW DESIGN WITH 16.7 MILLION COLORS

CONTROLLED BY SMART APP ON YOUR SMARTPHONE

DURABLE COMMERCIAL GRADE HOUSING RESISTANT TO RUST AND IMPACT

SMART CONTROL WITH APP



SMOOTHLY DIMMABLE AND CCT TUNABLE

FIXTURE GROUPING AND SCHEDULE PROGRAMMING



PRODUCT SIZE
2x2, 2x4

AVAILABLE POWER
35W, 40W

COLOR SELECTABLE
3500K-5000K-RGBW

LED TROFFER RETROFIT KIT

ASD-LTRK

COLOR AND POWER SELECTABLE

3CCT COLOR SELECTABLE

3PA POWER ADJUSTABLE

DURABLE IRON COMMERCIAL GRADE HOUSING

COLOR AND POWER SELECTABLE

ANTI-GLARE PC LENS WITH EVEN LIGHT DISTRIBUTION

QUICK AND EASY INSTALLATION



PRODUCT SIZE
2x2, 2x4

POWER ADJUSTABLE
30W, 45W

COLOR SELECTABLE
3500K-5000K



LED TROFFER LIGHT

ASD-LTR

BUILT-IN BATTERY BACK-UP

- MORE THAN 1400lm IN EMERGENCY MODE FOR 90min
- AUTOMATIC SELF-TESTING

COLOR AND POWER SELECTABLE

- 3CCT COLOR SELECTABLE
- 3PA POWER ADJUSTABLE

DURABLE IRON COMMERCIAL GRADE HOUSING

COLOR AND POWER SELECTABLE

ANTI-GLARE PC LENS WITH EVEN LIGHT DISTRIBUTION

QUICK AND EASY INSTALLATION

LED TROFFER LIGHT HIGH LUMENS

ASD-LTR

9,100 LUMENS

COLOR AND POWER SELECTABLE

- 5CCT COLOR SELECTABLE
- 4PA POWER ADJUSTABLE

130lm/W EXTREME EFFICIENCY

ANTI-GLARE PC LENS WITH EVEN LIGHT DISTRIBUTION

DURABLE IRON COMMERCIAL GRADE HOUSING

COLOR AND POWER SELECTABLE

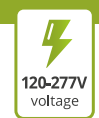

PRODUCT SIZE
2x2, 2x4

POWER ADJUSTABLE
30W, 45W

3CCT COLOR SELECTABLE
3500K-5000K

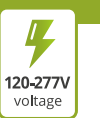

PRODUCT SIZE
2x4

POWER ADJUSTABLE
70W

5CCT COLOR SELECTABLE
3000K-6500K



LED TRIMLESS DOWNLIGHT

ASD-CD-T

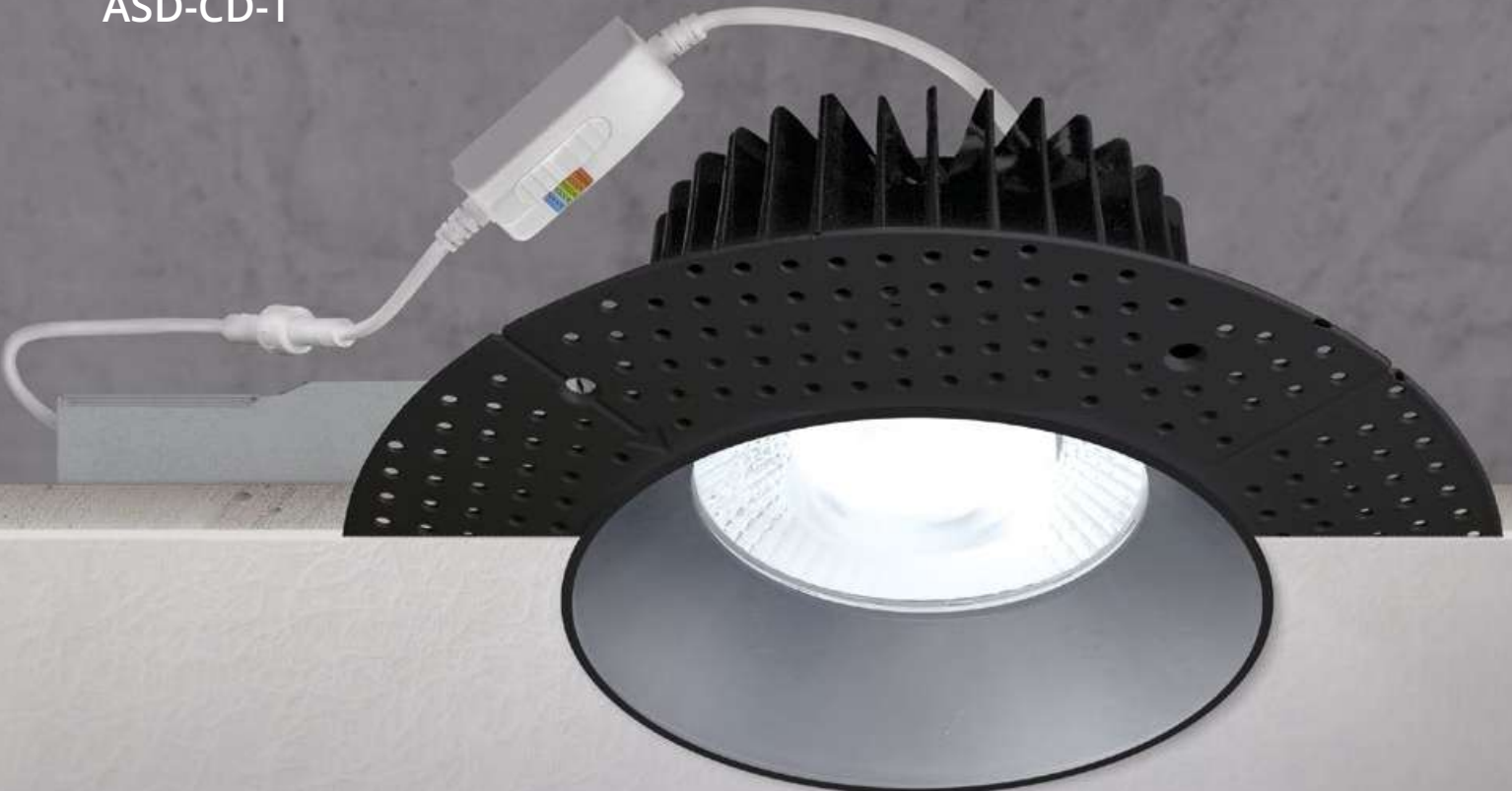

TWIST-LOCK DESIGN



CRI90+ RICH AND NATURAL COLORS

white



5 COLOR TEMPERATURE OPTIONS



IC RATED CANLESS SOLUTION

black



PRODUCT SIZE

1"-6"



AVAILABLE POWER

7W, 8W, 12W, 15W, 24W



COLOR SELECTABLE

2700K-5000K



BATTERY BACK-UP KIT



MORE THAN 1000lm IN EMERGENCY MODE FOR 90min



AUTOMATIC SELF-TESTING



OVERCHARGE AND OVER-DISCHARGE PROTECTION



UP TO 15W BATTERY BACK-UP POWER



COLOR SELECTABLE



5 COLOR TEMPERATURE OPTIONS



EASILY ADJUSTABLE VIA DIP SWITCH



ROUND SHAPE

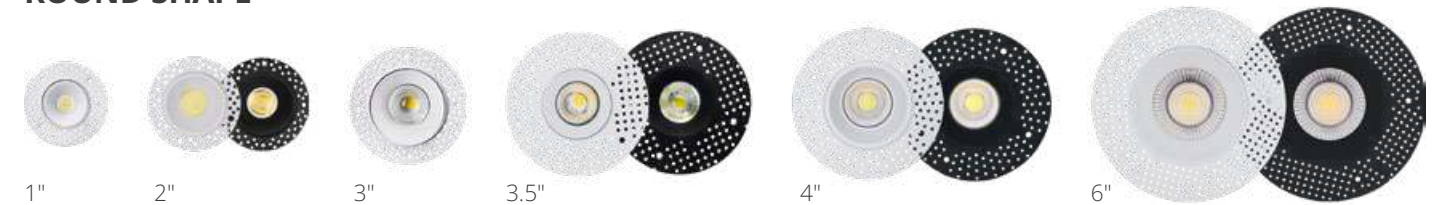

SQUARE SHAPE

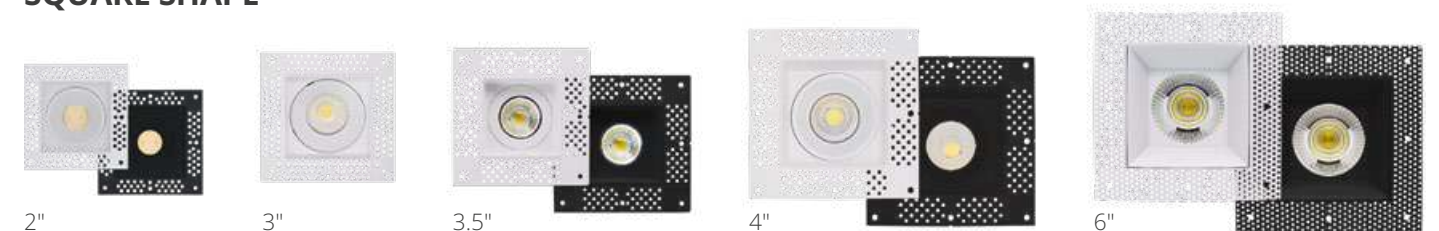

LED TRIMLESS DOWNLIGHT GIMBAL

ASD-CD-TG



BATTERY BACK-UP KIT

- MORE THAN 1000lm IN EMERGENCY MODE FOR 90min
- AUTOMATIC SELF-TESTING

LED TRIMLESS COMBO DOWNLIGHT

ASD-TCS

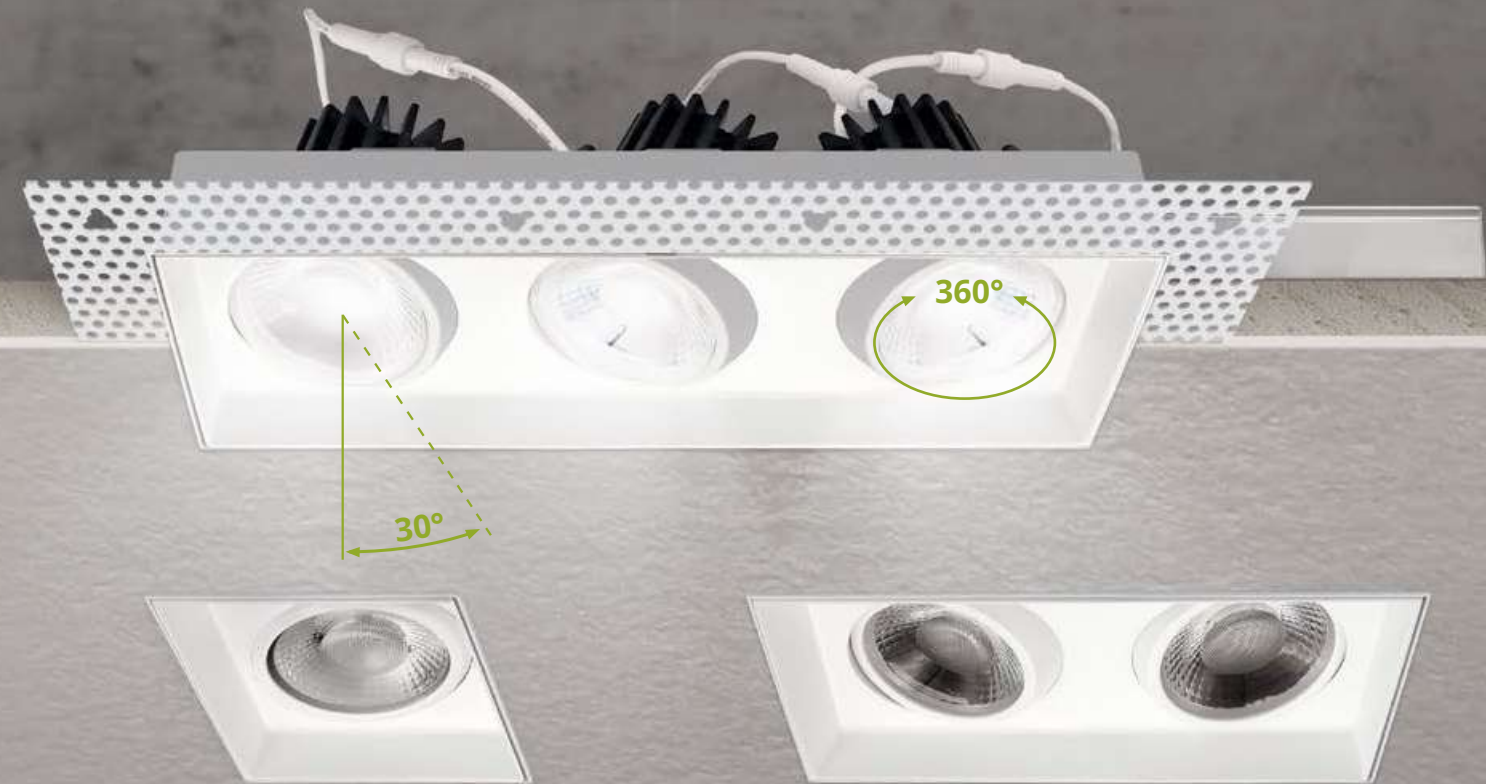

SWIVEL LENS WITH 30° TILT FOR DIRECTIONAL LIGHT CONTROL

CR190+ RICH AND NATURAL COLORS

white

5 COLOR TEMPERATURE OPTIONS

IC RATED CANLESS SOLUTION

black

MULTI-DIRECTIONAL ADJUSTABLE SWIVEL HEADS

CR190+ RICH AND NATURAL COLORS

5 COLOR TEMPERATURE OPTIONS

IC RATED CANLESS SOLUTION

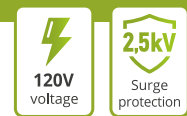

PRODUCT SIZE
2", 3", 4"

AVAILABLE POWER
8W, 12W, 17W

COLOR SELECTABLE
5 CCT 2700K-5000K

HEAD QUANTITY
1pc, 2pcs, 3pcs

AVAILABLE POWER
15W, 30W, 45W

COLOR SELECTABLE
5 CCT 2700K-5000K

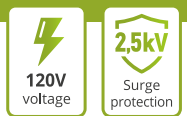

LED DOWNLIGHT 1 & 2 INCH

ASD-CD-P



 DURABLE AIRTIGHT ALUMINUM HOUSING WITH EXCELLENT HEAT DISSIPATION

 CRI90+ RICH AND NATURAL COLORS

white

 5 COLOR TEMPERATURE OPTIONS



 IC RATED CANLESS SOLUTION

black

 PRODUCT SIZES
1", 2"

 AVAILABLE POWER
7W, 8W, 15W

 COLOR SELECTABLE
2700K-5000K

 120V voltage
 2.5kV Surge protection

 120-277V voltage

BATTERY BACK-UP KIT

 MORE THAN 1000lm IN EMERGENCY MODE FOR 90min

 AUTOMATIC SELF-TESTING

 OVERCHARGE AND OVER-DISCHARGE PROTECTION

 UP TO 15W BATTERY BACK-UP POWER



WASH TRIM ASD-CD-PWR

 HOUSING WITH WASH TRIM

 MULTIFACETED SPECULAR REFLECTOR WITH A 38° BEAM ANGLE

 ACCENT LIGHTING WITH DIRECTIONAL CONTROL



ROUND SHAPE



ROUND SHAPE WITH WASH TRIM



SQUARE SHAPE



LED ROUND COMMERCIAL DOWNLIGHT

ASD-CDL7



COLOR AND POWER SELECTABLE



IC RATED CANLESS SOLUTION

white



CRI90+ RICH AND NATURAL COLORS



WET LOCATIONS RATED

black



PRODUCT SIZE
4"-10"



POWER ADJUSTABLE
13W, 22W, 30W, 40W



COLOR SELECTABLE
2700K-5000K



BATTERY BACK-UP KIT



MORE THAN 1000lm IN EMERGENCY MODE FOR 90min



AUTOMATIC SELF-TESTING



OVERCHARGE AND OVER-DISCHARGE PROTECTION



UP TO 15W BATTERY BACK-UP POWER



COLOR AND POWER SELECTABLE



COLOR SELECTABLE



POWER ADJUSTABLE



ROUND SHAPE



4"



6"



8"



10"

LED COMMERCIAL DOWNLIGHT

ASD-CDL7R ROUND
ASD-CDL7S SQUARE

125
lm/W
EFFICIENCY

 COLOR AND POWER SELECTABLE

 IC RATED CANLESS SOLUTION

 CRI90+ RICH AND NATURAL COLORS

 WET LOCATIONS RATED

 120-277V voltage

 2.5kV Surge protection

 **PRODUCT SIZE**
6", 8", 10"

 **POWER ADJUSTABLE**
30W, 35W, 40W

 **COLOR SELECTABLE**
2700K-5000K

 **BATTERY BACK-UP**

 MORE THAN 1700lm IN EMERGENCY MODE FOR 90min

 AUTOMATIC SELF-TESTING

 OVERCHARGE AND OVER-DISCHARGE PROTECTION



 **COLOR AND POWER SELECTABLE**

5CCT COLOR SELECTABLE

5PA POWER ADJUSTABLE



ROUND SHAPE



ROUND SHAPE WITH BATTERY BACK-UP



SQUARE SHAPE



LED AREA LIGHT WITH Q-BASE NEOX series

ASD-LSB5B-NEOX



**200
lm/W**
SERIES
NEOX

200lm/W
EXTREME EFFICIENCY

10kV SURGE PROTECTION AGAINST VOLTAGE AND CURRENT SURGES

COLOR AND POWER SELECTABLE

white silver

3G VIBRATION RATING

bronze black

120-277V
voltage

10kV
Surge protection

200-480V
voltage

POWER ADJUSTABLE
150W, 200W, 240W,
300W, 500W

COLOR SELECTABLE
3000K-5000K



BUILT-IN Q-BASE

MICROWAVE OR PIR MOTION SENSOR

REMOTE CONTROL
Sold separately



BUILT-IN PHOTOCELL

BUILT-IN DUSK TO DAWN PHOTOCELL

PHOTOCELL WITH ON/OFF SWITCH



COLOR AND POWER SELECTABLE

3 CCT COLOR SELECTABLE

3 PA POWER ADJUSTABLE

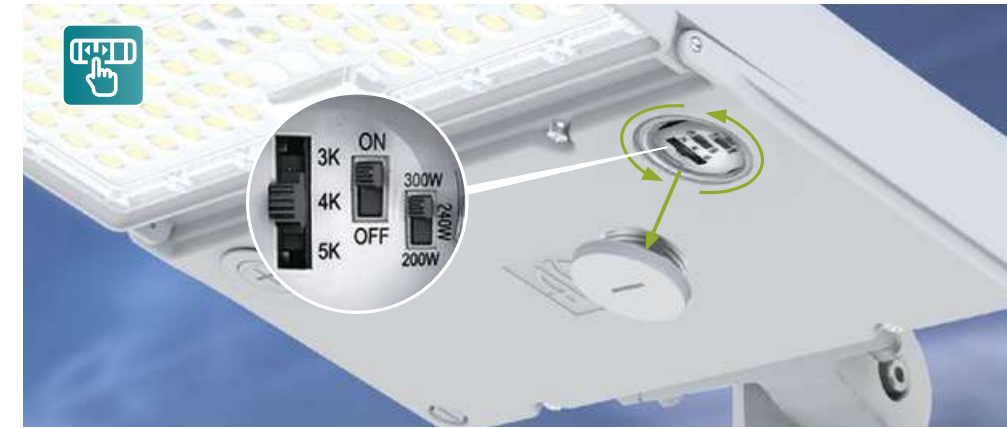

ARM MOUNTING BRACKET
ASD-AM-LSB5-BR
(for round & square poles)

ADJUSTABLE ARM MOUNTING BRACKET
ASD-AMR2-LSB-SL
(for round & square poles)

FLOODLIGHT MOUNTING BRACKET
ASD-FM3-LSB5B-BK

SLIP FITTER MOUNTING BRACKET
ASD-SF-LSB5-BR
(for poles Ø2")

FULL TRUNNION MOUNTING BRACKET
ASD-TR2-LSB-WH

WALL MOUNTING BRACKET
ASD-WMB-LSB-BR

LED AREA LIGHT WITH Q-BASE PRO series

ASD-LSB5B-PRO

170
lm/W
PRO

UP TO
750
WATTS

170lm/W
HIGH EFFICIENCY

10kV SURGE PROTECTION AGAINST
VOLTAGE AND CURRENT SURGES

COLOR AND POWER
SELECTABLE

3G VIBRATION RATING

white silver

bronze black

120-277V
voltage 10kV
Surge
protection

200-480V
voltage

POWER ADJUSTABLE
150W, 200W, 240W, 300W,
500W, 750W

COLOR SELECTABLE
3000K-5000K

**BUILT-IN
Q-BASE**

MICROWAVE OR PIR
MOTION SENSOR

REMOTE CONTROL
Sold separately



**BUILT-IN
PHOTOCELL**

BUILT-IN
DUSK TO DAWN PHOTOCELL

PHOTOCELL
WITH ON/OFF SWITCH



**COLOR AND POWER
SELECTABLE**

3CCT COLOR SELECTABLE

3PA POWER ADJUSTABLE



**ARM MOUNTING
BRACKET**
ASD-AM-LSB5-BR
(for round & square poles)



**FLOODLIGHT
MOUNTING BRACKET**
ASD-FM3-LSB5B-BK



**SLIP FITTER
MOUNTING BRACKET**
ASD-SF-LSB5-BR
(for poles Ø2")



**FULL TRUNNION
MOUNTING BRACKET**
ASD-TR2-LSB-WH



**WALL MOUNTING
BRACKET**
ASD-WMB-LSB-BR

LED ROUND AREA LIGHT WITH Q-BASE

ASD-LSB5R-PRO

170
lm/W
PRO

170lm/W
EXTREME EFFICIENCY

10kV SURGE PROTECTION AGAINST
VOLTAGE AND CURRENT SURGES

COLOR AND POWER
SELECTABLE

1.5G
1.5G VIBRATION RATING

bronze

black

120-277V
voltage

10kV
Surge
protection

**POWER
ADJUSTABLE**
100W

**COLOR
SELECTABLE**
3000K-5000K

**BUILT-IN
Q-BASE**

MICROWAVE OR PIR
MOTION SENSOR

REMOTE CONTROL
Sold separately



**BUILT-IN
PHOTOCELL**

BUILT-IN
DUSK TO DAWN PHOTOCELL

PHOTOCELL
WITH ON/OFF SWITCH



**COLOR AND POWER
SELECTABLE**

3CCT COLOR SELECTABLE

4PA POWER ADJUSTABLE

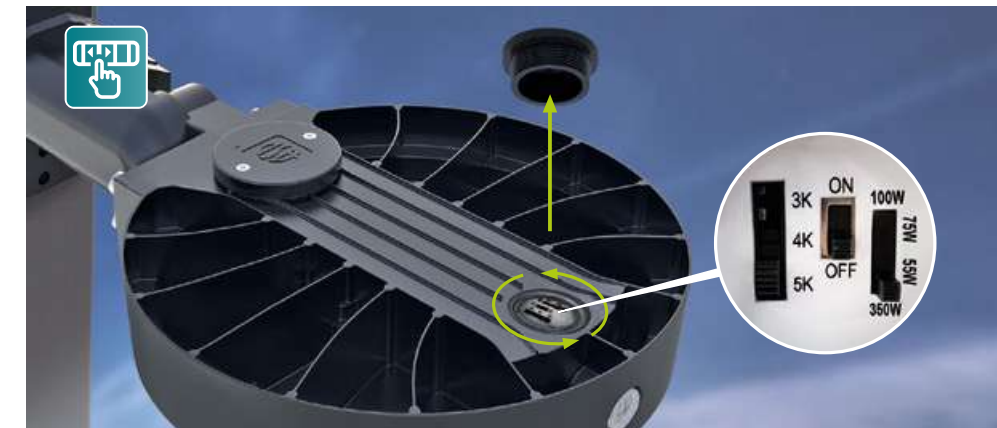

POST BRACKET
ASD-POST-LSB5

**ARM MOUNTING
BRACKET**
ASD-AM-LSB5-BK
(for round & square poles)

**ADJUSTABLE ARM
MOUNTING BRACKET**
ASD-AMR-LSB5-BK
(for round & square poles)

**SLIP FITTER
MOUNTING BRACKET**
ASD-SF-LSB5-BK
(for poles Ø2")

**FULL TRUNNION
MOUNTING BRACKET**
ASD-TR-LSB5-BK

MOUNTING BRACKETS FOR LED AREA LIGHTS



ARM MOUNTING BRACKET
ASD-AM-LSB5
(for round & square poles)



ADJUSTABLE ARM MOUNTING BRACKET
ASD-AMR-LSB
(for round & square poles)



FULL TRUNNION MOUNTING BRACKET
ASD-TR-LSB



FLOODLIGHT MOUNTING BRACKET
ASD-FM-LSB5B



POST BRACKET
ASD-POST-LSB5



SLIP FITTER MOUNTING BRACKET
ASD-SF-LSB5 (for poles Ø2")

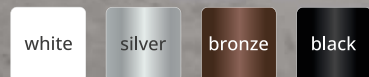

MOUNTING BRACKETS FOR LED AREA LIGHTS



WALL MOUNTING BRACKET
ASD-WMB-LSB



DUAL BULL TENON BRACKET
ASD-B2BT



TENON BRACKET
ASD-TN-BR



TRIPLE BULL TENON BRACKET
ASD-B3BT

LED SPORT LIGHT

ASD-SPFL7

150
lm/W
EFFICIENCY

 DIE-CAST ALUMINUM HOUSING WITH EXCELLENT HEAT DISSIPATION



 SURGE PROTECTION AGAINST VOLTAGE AND CURRENT SURGES

 CRI80+ RICH AND NATURAL COLORS

 3G VIBRATION RATING

 **POWER ADJUSTABLE**
300W, 500W, 750W, 1000W, 1300W

 **COLOR TEMPERATURE**
5000K

 120-277V voltage
 10kV Surge protection

 200-480V voltage

UP-LIGHT SERIES

 FOR UPLIGHT APPLICATIONS

 IDEAL FOR ARCHITECTURAL AND AMBIENT LIGHTING

 AVAILABLE POWER 500W, 750W



300W-500W MODELS

LENS 45° (by default)

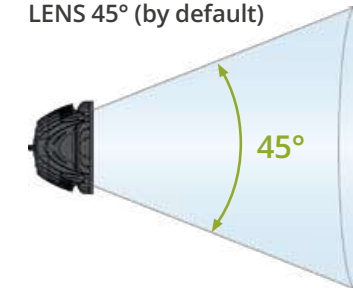

LENS 30° (sold separately)

ASD-L30-SPFL7-300/500 (for 300-500W)

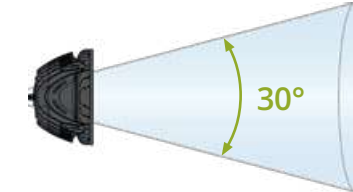

750W-1300W MODELS

LENS 40° (by default)

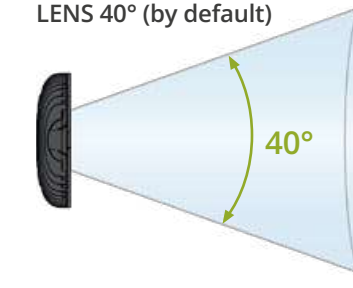

LENS 20° (sold separately)

ASD-L20B-SPFL7 (for 750W)
ASD-L20C-SPFL7 (for 1000-1300W)

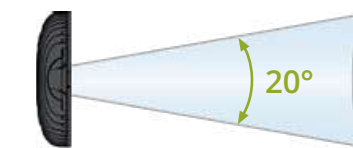

LENS 60° (sold separately)

ASD-L60B-SPFL7-750 (for 750W)
ASD-L60C-SPFL7-1000/1300 (for 1000-1300W)

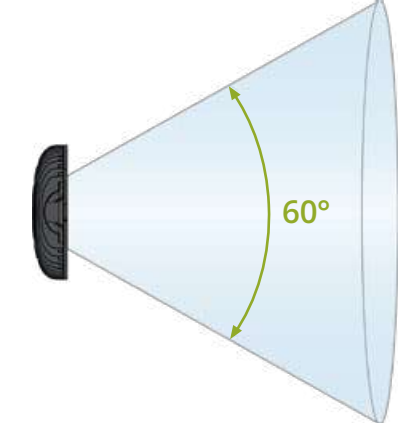

INCLUDED

U BRACKET



SLIP-FITTER BRACKET



LASER POINTER

LED SPORT LIGHT WITH DMX & RGBW

ASD-SPFL7-DMX



DMX DMX CONTROL

- DMX DMX PROTOCOL
- SUITABLE FOR HIGHLY DYNAMIC LIGHT SHOWS

RGBW RGBW LIGHTING

- RGBW DESIGN WITH RED, GREEN, BLUE, WHITE COLORS OR ITS COMBINATIONS
- SUITABLE FOR HIGHLY DYNAMIC LIGHT SHOWS

DMX DMX CUSTOM CONTROLS

CRI80+ RICH AND NATURAL COLORS

SURGE PROTECTION AGAINST VOLTAGE AND CURRENT SURGES

3G 3G VIBRATION RATING

LENS BEAM ANGLES:
300-500W
Default - 45°;
Option - 30°

200-480V voltage
10kV Surge protection

W AVAILABLE POWER
450W, 500W

5CCT COLOR SELECTABLE
2700-6500-**RGBW**



LED SPORT LIGHT

ASD-SPFL8



140 lm/W EFFICIENCY

DMX DMX, DALI-2 AND 0-10V CONTROLS

- DMX DMX PROTOCOL
- DALI DALI-2 PROTOCOL
- 0-10V 0-10V PROTOCOL

DIE-CAST ALUMINUM HOUSING WITH EXCELLENT HEAT DISSIPATION

CRI80+ RICH AND NATURAL COLORS

SURGE PROTECTION AGAINST VOLTAGE AND CURRENT SURGES

3G 3G VIBRATION RATING

LENS BEAM ANGLES:
1600-1800W
Default - 17°

200-480V voltage
10kV Surge protection

W AVAILABLE POWER
1600W, 1800W

K COLOR TEMPERATURE
5000K



LED SLIM CANOPY

ASD-CAN05



140
lm/W
EFFICIENCY

COLOR AND POWER SELECTABLE

- 3CCT COLOR SELECTABLE
- 3PA POWER ADJUSTABLE

DIE-CAST ALUMINUM HOUSING WITH EXCELLENT HEAT DISSIPATION

SURGE PROTECTION AGAINST VOLTAGE AND CURRENT SURGES

ANTI-GLARE PC LENS WITH EVEN LIGHT DISTRIBUTION

COLOR AND POWER SELECTABLE

W POWER ADJUSTABLE
40W, 70W

3CCT COLOR SELECTABLE
3000K-5000K

120-277V voltage
5kV Surge protection



LED LOW-PROFILE CANOPY WITH Q-BASE

ASD-CAN07A



140
lm/W
EFFICIENCY

BUILT-IN Q-BASE

- INFRARED, MICROWAVE SENSORS WITH REMOTE CONTROL
- INFRARED, MICROWAVE NLS SENSORS WITH ASD NLS APP

BUILT-IN BATTERY BACK-UP

- MORE THAN 1300lm IN EMERGENCY MODE FOR 90min
- AUTOMATIC SELF-TESTING

Q-BASE

3 COLOR TEMPERATURE OPTIONS

white

DIE-CAST ALUMINUM HOUSING WITH EXCELLENT HEAT DISSIPATION

SURGE PROTECTION AGAINST VOLTAGE AND CURRENT SURGES

black

W AVAILABLE POWER
45W, 70W

3CCT COLOR SELECTABLE
3000K-5000K

120-277V voltage
6kV Surge protection



LED SQUARE EDGE-LIT CANOPY WITH Q-BASE

ASD-CAN09S



140
lm/W
EFFICIENCY



COLOR AND POWER SELECTABLE

- 3CCT COLOR SELECTABLE
- 3PA POWER ADJUSTABLE

BUILT-IN BATTERY BACK-UP

- MORE THAN 1300lm IN EMERGENCY MODE FOR 90min
- AUTOMATIC SELF-TESTING



Q-BASE



COLOR AND POWER SELECTABLE

white



DIE-CAST ALUMINUM HOUSING WITH EXCELLENT HEAT DISSIPATION



SURGE PROTECTION AGAINST VOLTAGE AND CURRENT SURGES

black

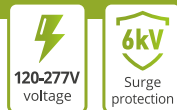

W POWER ADJUSTABLE
50W, 80W, 100W

3CCT COLOR SELECTABLE
3000K-5000K



LED SECURITY WALLPACK

ASD-SWP



BUILT-IN BATTERY BACK-UP

- MORE THAN 400lm IN EMERGENCY MODE FOR 90min
- AUTOMATIC SELF-TESTING

BUILT-IN PHOTOCELL

- BUILT-IN DAYLIGHT SENSOR
- PHOTOCELL WITH ON/OFF SWITCH



ANTI-GLARE PC LENS



EVEN LIGHT DISTRIBUTION



3 COLOR TEMPERATURE OPTIONS



WET LOCATIONS RATED



W POWER ADJUSTABLE
28W

3CCT COLOR SELECTABLE
3000K-5000K



LED TRADITIONAL WALLPACK

ASD-WLP01



150
lm/W
EFFICIENCY



BUILT-IN BATTERY BACK-UP

- MORE THAN 2300lm IN EMERGENCY MODE FOR 90min
- AUTOMATIC SELF-TESTING

BUILT-IN PHOTOCELL

- BUILT-IN DUSK TO DAWN PHOTOCELL
- PHOTOCELL WITH ON/OFF SWITCH

DIE-CAST ALUMINUM HOUSING WITH EXCELLENT HEAT DISSIPATION

3 COLOR TEMPERATURE OPTIONS

TEMPERED GLASS LENS FOR HIGH ILLUMINANCE

SURGE PROTECTION AGAINST VOLTAGE AND CURRENT SURGES

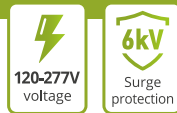

W POWER ADJUSTABLE
50W, 80W, 120W, 150W

3CCT COLOR SELECTABLE
3000K-5000K



LED ADJUSTABLE CUTOFF WALLPACK

ASD-WLP02A

140
lm/W
EFFICIENCY



BUILT-IN PHOTOCELL

- BUILT-IN DUSK TO DAWN PHOTOCELL
- PHOTOCELL WITH ON/OFF SWITCH

DIE-CAST ALUMINUM HOUSING WITH EXCELLENT HEAT DISSIPATION

ADJUSTABLE CUTOFF DESIGN 0-90°

SURGE PROTECTION AGAINST VOLTAGE AND CURRENT SURGES

3 COLOR TEMPERATURE OPTIONS

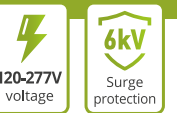

W AVAILABLE POWER
12W, 30W, 50W

3CCT COLOR SELECTABLE
3000K-5000K



LED FULL CUTOFF WALLPACK

ASD-WLP03

145
lm/W
EFFICIENCY



COLOR AND POWER SELECTABLE

- 3 CCT COLOR SELECTABLE
- 3 PA POWER ADJUSTABLE

PHOTOCELL KIT

- DUSK TO DAWN PHOTOCELL KIT
- PHOTOCELL WITH ON/OFF SWITCH

DIE-CAST ALUMINUM HOUSING WITH EXCELLENT HEAT DISSIPATION

FULL CUTOFF DESIGN WITH DIRECTED LIGHT

SURGE PROTECTION AGAINST VOLTAGE AND CURRENT SURGES

COLOR AND POWER SELECTABLE

120-277V voltage
4kV Surge protection

W POWER ADJUSTABLE
50W, 80W, 120W

3 CCT COLOR SELECTABLE
3000K-5000K



LED SLIM WALLPACK

ASD-WLS

140
lm/W
EFFICIENCY



BUILT-IN PHOTOCELL

- BUILT-IN DUSK TO DAWN PHOTOCELL
- PHOTOCELL WITH ON/OFF SWITCH

COLOR AND POWER SELECTABLE

- 3 CCT COLOR SELECTABLE
- 3 PA POWER ADJUSTABLE

DIE-CAST ALUMINUM HOUSING WITH EXCELLENT HEAT DISSIPATION

REMOVABLE HINGE DOOR FOR QUICK AND EASY WIRING

TEMPERED GLASS LENS FOR HIGH ILLUMINANCE

SURGE PROTECTION AGAINST VOLTAGE AND CURRENT SURGES

120-277V voltage
6kV Surge protection

W POWER ADJUSTABLE
50W, 60W, 80W, 120W

3 CCT COLOR SELECTABLE
3000K-5000K



LED ROUND WALLPACK

ASD-WLR
DOWN LIGHT



150
lm/W
EFFICIENCY

ASD-WLR-UD
UP & DOWN LIGHT



- BUILT-IN PHOTOCELL
- BUILT-IN DUSK TO DAWN PHOTOCELL
- PHOTOCELL WITH ON/OFF SWITCH

- COLOR AND POWER SELECTABLE
- 3CCT** COLOR SELECTABLE
- 3PA** POWER ADJUSTABLE

DIE-CAST ALUMINUM HOUSING WITH EXCELLENT HEAT DISSIPATION

ANTI-GLARE PC LENS WITH EVEN LIGHT DISTRIBUTION

DOWN OR UP & DOWN ILLUMINATION

COLOR AND POWER SELECTABLE

LIGHT DIRECTION
Down, up & down

POWER ADJUSTABLE
60W, 120W

COLOR SELECTABLE
3000K-5000K

120-277V voltage
 6kV Surge protection



161 INFO PAGE

VAPOR JELLY JAR RGBCW LIGHT

ASD-VTJ



180°



- BUILT-IN PHOTOCELL
- BUILT-IN DUSK TO DAWN PHOTOCELL
- PHOTOCELL WITH ON/OFF SWITCH

DURABLE COMMERCIAL GRADE HOUSING RESISTANT TO RUST AND IMPACT

BUILT-IN PHOTOCELL WITH ON/OFF SWITCH

RGBCW WITH SIMPLE SWITCH

SURGE PROTECTION AGAINST VOLTAGE SPIKES AND CURRENT SURGES

POWER ADJUSTABLE
20W

COLOR SELECTABLE
3000K-5000K-RED-GREEN-BLUE

120-277V voltage
 4kV Surge protection



162 INFO PAGE

LED DUAL-HEAD SECURITY LIGHTS

ASD-SFL



OPERATING MODE	ON TIME / AUTO / D2D
DETECTION DISTANCE	19 – 60ft (5.8 – 18m) adjustable
INSTALLATION HEIGHT	8.2ft (2.5m)
AMBIENT LIGHT	< 10Lux (< 0.9fc)
HOLD-TIME	10s – 10min
DETECTION MOTION SPEED	0.6 – 1.5m/s
DETECTION RANGE	Horizontal 180°, Vertical 180°

ROTATABLE LIGHT HEADS FOR DIRECTIONAL LIGHT CONTROL

INSTALLATION ON A REGULAR JUNCTION BOX

white

5 COLOR TEMPERATURE OPTIONS

WET LOCATIONS RATED

black

120V voltage

AVAILABLE POWER
20W

COLOR SELECTABLE
2700K-5000K

BUILT-IN MOTION SENSOR ASD-SFL, ASD-SFL-SC

- FLEXIBLE SETTINGS: ON TIME/AUTO/D2D
- ON** ON-TIME: WORKS LIKE A NORMAL LAMP WITHOUT SENSING
- D2D** D2D DUSK TO DAWN: AUTOMATICALLY TURNS ON AT DUSK AND OFF AT DAWN
- AUTO** AUTO: AUTO ON & OFF BASED ON MOTION DETECTION AND LUX REQUIREMENT SETTINGS

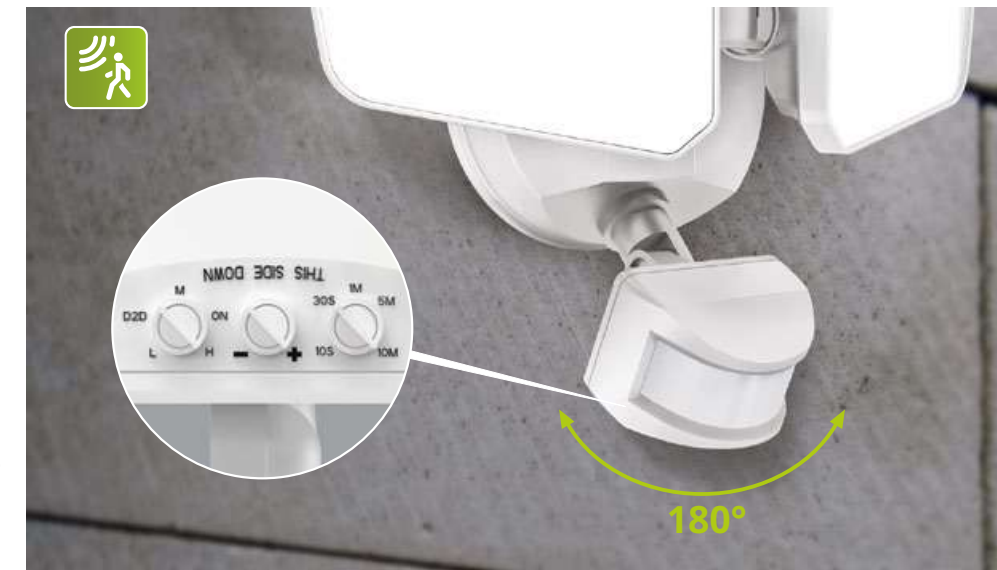

BUILT-IN PHOTOCELL ASD-SFL

- BUILT-IN DAYLIGHT SENSOR
- FLEXIBLE SETTINGS: ON TIME/AUTO/D2D



BUILT-IN CAMERA ASD-SFL-SC

- CONTROLLED BY SMART APP ON YOUR SMARTPHONE
- SMART SECURITY CAMERA WITH MICRO SD CARD
- FULL HD 1296P FULL HD VIDEO STREAMING AND RECORDING
- WORKS WITH ALEXA AND GOOGLE ASSISTANT



Q-BASE MOTION SENSOR

Microwave Motion Sensor

With magnet base

With audio-jack base



ASD-M2MW-WH



ASD-08MW-WH

Infrared Motion Sensor

With clip-in base



ASD-M22IR-WH

SETTINGS

DETECTION AREA
HOLDTIME
DAYLIGHT THRESHOLD
STAND-BY DIMMING LEVEL
STAND-BY PERIOD

ASD-M2MW-WH	DEFAULT	ADJUSTMENTS
DETECTION AREA	100%	25% - 100%
HOLDTIME	10min	5s - 30min
DAYLIGHT THRESHOLD	DISABLE	2 - 120Lux
STAND-BY DIMMING LEVEL	10%	10 - 50%
STAND-BY PERIOD	0s	0s - +∞

ASD-08MW-WH	DEFAULT	ADJUSTMENTS
DETECTION AREA	100%	25% - 100%
HOLDTIME	10min	5s - 120min
DAYLIGHT THRESHOLD	DISABLE	2 - 400Lux
STAND-BY DIMMING LEVEL	10%	10 - 50%
STAND-BY PERIOD	0s	0s - +∞

ASD-M22IR-WH	DEFAULT	ADJUSTMENTS
DETECTION AREA	100%	25% - 100%
HOLDTIME	30s	5s - 30min
DAYLIGHT THRESHOLD	DISABLE	2 - 400Lux
STAND-BY DIMMING LEVEL	10%	10 - 50%
STAND-BY PERIOD	0s	0s - +∞

QUICK ADJUSTMENTS WITH A REMOTE CONTROL

EASY INSTALLATION

DETECTION DISTANCE UP TO 26ft

EMERGENCY BACK-UP COMPATIBILITY



ASD-06RC



BACK-LIT PANELS WITH ASD-M2MW-WH



STRIPLIGHTS WITH ASD-08MW-WH



STRIPLIGHTS WITH ASD-M22IR-WH

MOTION SENSOR WITH 3-PIN BASE

Infrared Motion Sensor

Installation height 39ft



ASD-09IR-WH ASD-09IR-BK ASD-S10IR-WH

Installation height 50ft



ASD-09IR50-WH

Microwave Motion Sensor

Installation height 49ft



ASD-09MW-WH ASD-09MW-BK

SETTINGS

DETECTION AREA
HOLDTIME
DAYLIGHT THRESHOLD
STAND-BY DIMMING LEVEL
STAND-BY PERIOD

DEFAULT
100%
10min
DISABLE
10%
0s

ADJUSTMENTS
25% - 100%
5s - 30min
2 - 400Lux
0 - 50%
0s - +∞



ASD-06RC

QUICK ADJUSTMENTS WITH BUILT-IN DIAL OR REMOTE CONTROL

WET LOCATIONS RATED

INSTALLATION HEIGHT UP TO 50ft

EMERGENCY BACK-UP COMPATIBILITY

white

black



LINEAR HIGH BAY



LINEAR NARROW HIGH BAY



UFO HIGH BAY



CANOPIES



AREA LIGHTS

EMERGENCY BATTERY BACK-UP KIT

Battery Back-Up kit
For LED UFO HIGH BAY 120-277V

40W 60W



BLD-RM40R
BLD-RM60R

40W 60W



ASD-EMB40
ASD-EMB60

Battery Back-Up kit
For LED UFO HIGH BAY 277-480V

60W



BLD-GM60R-HV

MORE THAN 90 MINUTES OF OPERATION IN EMERGENCY MODE

REGULAR SELF TESTING

WITH MULTI-PROTECTION FUNCTION

WET LOCATIONS RATED



EMERGENCY BATTERY BACK-UP KIT

Battery Back-Up kit
For LED LINEAR HIGH BAY

20W 30W



ASD-EMK20W-WHB5B (compatible with WHB5B)
ASD-EMK30W-WHB5A (compatible with WHB5B)

MORE THAN 90 MINUTES OF OPERATION IN EMERGENCY MODE

BACK-UP OR AC MODE INDICATOR

Battery Back-Up kit
For LED COMMERCIAL DOWNLIGHT

8W 15W



BLD-HM08D
BLD-HM15D

15W



ASD-EMA15

REGULAR SELF TESTING

MULTI-PROTECTION FUNCTION



UFO HIGH BAY WITH BLD-RM40R



UFO HIGH BAY WITH ASD-EMB60



UFO HIGH BAY WITH BLD-GM60R-HV



LINEAR HIGH BAY WITH EMK20W-WHB5B



DOWNLIGHT WITH BLD-HM15D



DOWNLIGHT WITH ASD-EMA15

LED FLUSHMOUNT LOFT

ASD-LOFT-FM



CONTEMPORARY SOLUTION TO REPLACE OLD FLUSHMOUNTS



5 COLOR TEMPERATURE OPTIONS



nickel



ACRYLIC LENS WITH EVEN LIGHT DISTRIBUTION



SEAMLESS TRIAC DIMMING



black



PRODUCT SIZE

12", 14", 16", 18", 20"



AVAILABLE POWER

20W-42W



COLOR SELECTABLE

2700K-5000K



120V voltage



RGBW LIGHTING MODELS

ASD-LOFT-FM-RGBW



PRODUCT SIZE
12", 16", 20"



RGBW DESIGN WITH 16.7 MILLION COLORS



CONTROLLED BY SMART APP ON YOUR SMARTPHONE



COMPATIBLE WITH ALEXA AND GOOGLE ASSISTANT



LED VANITY LINEAR LOFT

ASD-LOFT-VF



PRODUCT SIZES 24", 36", 48"



AVAILABLE POWER
25W, 30W, 35W



5 COLOR TEMPERATURE OPTIONS



DURABLE HOUSING RESISTANT TO RUST AND IMPACT

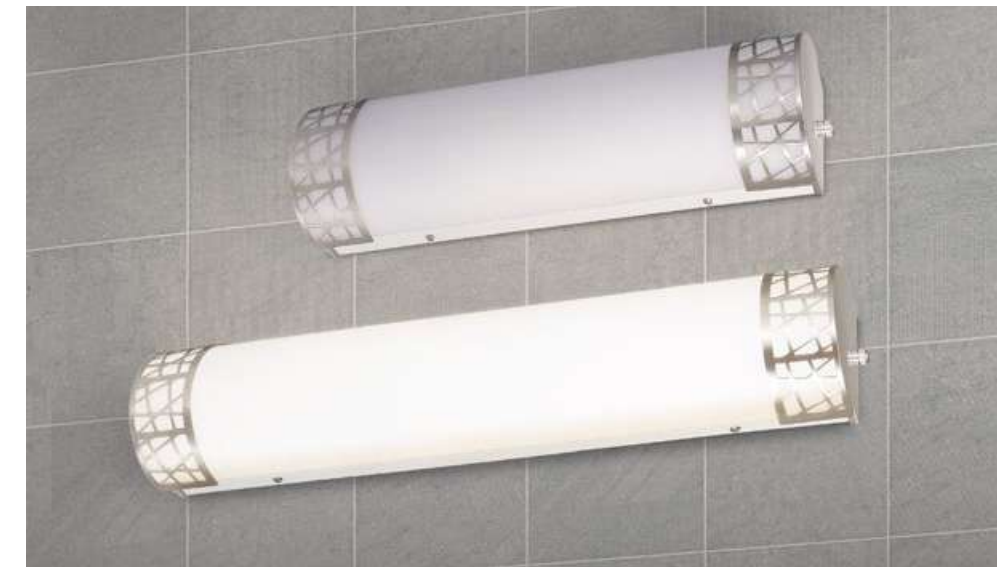

LED WALL SCONCE LOFT

ASD-LOFT-WS



PRODUCT SIZE 12"



AVAILABLE POWER 15W



5 COLOR TEMPERATURE OPTIONS



DURABLE HOUSING RESISTANT TO RUST AND IMPACT





LED DOUBLE RING FLUSHMOUNT

ASD-LFMDR



 DURABLE HOUSING RESISTANT TO RUST AND IMPACT

 3 COLOR TEMPERATURE OPTIONS

 nickel  bronze

 ACRYLIC LENS WITH EVEN LIGHT DISTRIBUTION

 2.75" AND 3.5" MOUNTING HOLES FOR ADVANCED INSTALLATION OPTIONS

 black

 **PRODUCT SIZE**
10", 12", 14", 16", 18"

 **AVAILABLE POWER**
16W-28W

 **COLOR SELECTABLE**
3000K-5000K

 120V voltage

 120-277V voltage

 **BUILT-IN BATTERY BACK-UP**
ASD-LFMDR-EM

 **PRODUCT SIZE**
12", 14", 16"

 **MORE THAN 1000lm**
IN EMERGENCY MODE FOR 90min

 **BUILT-IN WORKING MODE INDICATOR**

 **12W**
BATTERY BACK-UP POWER

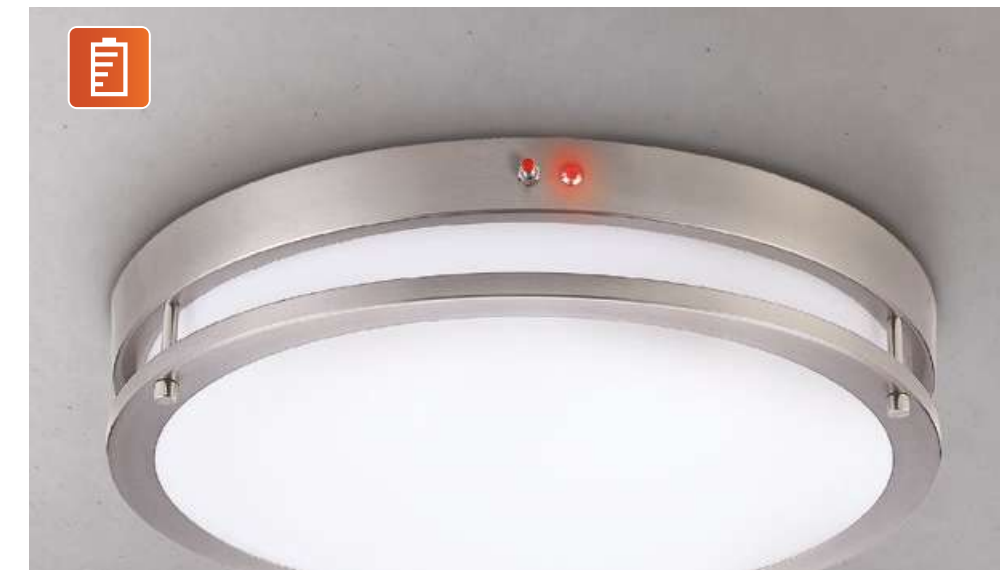

 **COLOR SELECTABLE**

 **3 COLOR TEMPERATURE OPTIONS**

 **COLOR SELECTABLE SWITCH ON PLATE**



 **RGBW LIGHTING MODELS**
ASD-LFMDR-RGBW

 **PRODUCT SIZE**
14", 16", 18"

 **RGBW DESIGN**
WITH 16.7 MILLION COLORS

 **CONTROLLED BY SMART APP**
ON YOUR SMARTPHONE

 **COMPATIBLE WITH ALEXA AND GOOGLE ASSISTANT**



LED OVAL DOUBLE RING FLUSHMOUNT

ASD-FMOV



ACRYLIC LENS WITH EVEN LIGHT DISTRIBUTION



5 COLOR TEMPERATURE OPTIONS



nickel



bronze



OPERATE ON 120-277V CIRCUITS



SEAMLESS TRIAC DIMMING



black



PRODUCT SIZE

24", 32"



AVAILABLE POWER

38W, 45W, 50W



COLOR SELECTABLE

2700K-5000K



LED OVAL EDGE LIT PANEL

ASD-MPO



ACRYLIC LENS WITH EVEN LIGHT DISTRIBUTION



5 COLOR TEMPERATURE OPTIONS



OPERATE ON 120-277V CIRCUITS



CRI90+ RICH AND NATURAL COLORS



PRODUCT SIZE

32"



AVAILABLE POWER

45W



COLOR SELECTABLE

2700K-6000K



LED EDGE LIT PANEL

ASD-MP



ACRYLIC LENS WITH EVEN LIGHT DISTRIBUTION



CRI90+ RICH AND NATURAL COLORS



5 COLOR TEMPERATURE OPTIONS



J-BOX, CAN MOUNT, SUB-PLATE OR PENDANT INSTALLATION



PRODUCT SIZE

5", 7", 9", 12", 15", 18", 24", 32"



AVAILABLE POWER

10W-45W



COLOR SELECTABLE

2700K-6000K

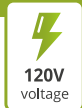

BUILT-IN PHOTOCELL & MOTION SENSOR

ASD-MPR-MS



PRODUCT SIZE
7", 9", 12"



BUILT-IN INFRARED MOTION SENSOR



BUILT-IN PHOTOCELL



BUILT-IN BATTERY BACK-UP

ASD-MPR-EM



PRODUCT SIZE
7", 9", 12"



90 MINUTES OF POWER IN CASE OF EMERGENCY



BUILT-IN WORKING MODE INDICATOR



BATTERY BACK-UP POWER UP TO 12W

ROUND SHAPE



ROUND SHAPE WITH MOTION SENSOR



ROUND SHAPE WITH BATTERY BACK-UP



SQUARE SHAPE



J-BOX MOUNT INSTALLATION
(for 2.75" and 3.5" mounting holes)



CAN MOUNT INSTALLATION
(for 4" and 6" housings)



SUB-PLATE INSTALLATION
(for 2.75" and 3.5" mounting holes)



PENDANT INSTALLATION
(for 15", 18", 24" and 32" housings)

LED DISK LIGHT

ASD-LDS



LOW-PROFILE DESIGN IS PERFECT FOR SPACES WITH LOW CEILINGS



2.75", 3.5" AND 4" MOUNTING HOLES FOR ADVANCED INSTALLATION OPTIONS



5 COLOR TEMPERATURE OPTIONS



J-BOX OR CAN MOUNT INSTALLATION

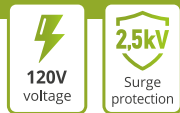

PRODUCT SIZE
4", 6"



AVAILABLE POWER
10W, 15W



COLOR SELECTABLE
2700K-5000K



BUILT-IN MOTION SENSOR
ASD-LDS-MS



PRODUCT SIZE
6"



AUTOMATICALLY SWITCHES ON/OFF



BUILT-IN ADJUSTABLE MOTION SENSOR



DETECTION RANGE
UP TO 15ft



BATTERY BACK-UP KIT



90 MINUTES OF POWER IN CASE OF EMERGENCY



BUILT-IN WORKING MODE INDICATOR



13W BATTERY BACK-UP POWER

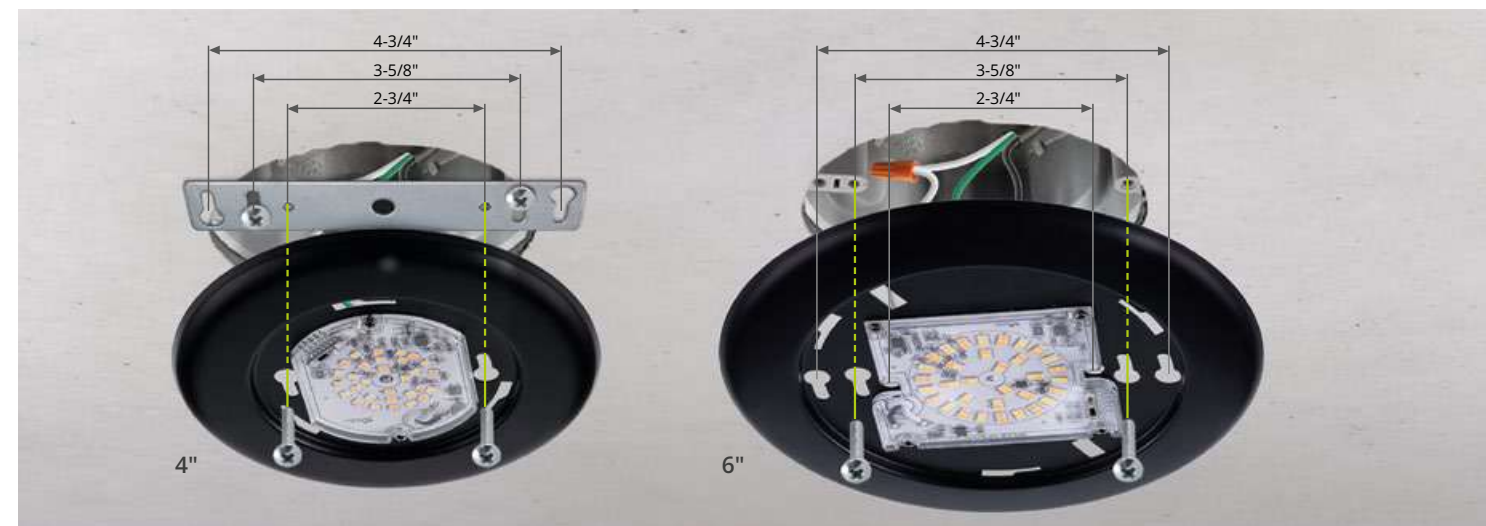

2.75", 3.5" AND 4" MOUNTING HOLES

LED WAFER

ASD-JB



LOW-PROFILE DESIGN IS AN IDEAL SOLUTION FOR LOW CEILINGS



5 COLOR TEMPERATURE OPTIONS



white

nickel



CRI90+ RICH AND NATURAL COLORS



IC RATED CANLESS SOLUTION



bronze

black

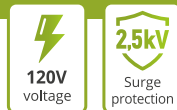

120V voltage

2.5kV Surge protection



PRODUCT SIZE

3", 4", 6", 8", 12"



AVAILABLE POWER

6W-27W



COLOR SELECTABLE

2700K-5000K



BATTERY BACK-UP



90 MINUTES OF POWER IN CASE OF EMERGENCY



BUILT-IN WORKING MODE INDICATOR



BUILT-IN BATTERY BACK-UP POWER 4.2W



BATTERY BACK-UP KIT POWER UP TO 15W



RGBW LIGHTING MODELS
ASD-JBR-RGBW



PRODUCT SIZE
6"



RGBW DESIGN WITH 16.7 MILLION COLORS



CONTROLLED BY SMART APP ON YOUR SMARTPHONE



COMPATIBLE WITH ALEXA AND GOOGLE ASSISTANT



ROUND SHAPE



ROUND SHAPE WITH BATTERY BACK-UP



ROUND SHAPE WITH RGBW



SQUARE SHAPE

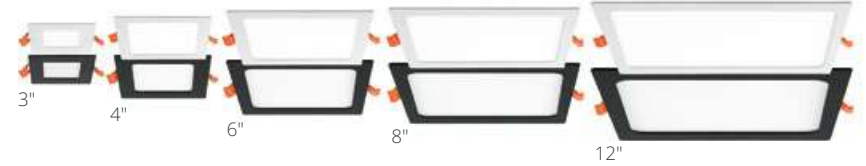

SQUARE SHAPE WITH ROUND BACK

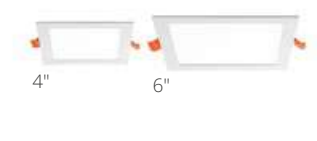

ROUND SHAPE

With 3", 4", 6", 8" and 12" sizes



SQUARE SHAPE

With 3", 4", 6", 8" and 12" sizes



SQUARE SHAPE WITH ROUND BACK

With 4" and 6" sizes

LED ROUND WAFER WITH NIGHT LIGHT

ASD-JBR-NL



2000K NIGHT LIGHT



5 COLOR TEMPERATURE OPTIONS

white



CRI90+ RICH AND NATURAL COLORS



IC RATED CANLESS SOLUTION

black



120V voltage



PRODUCT SIZE

4", 6"



AVAILABLE POWER

9W, 12W



COLOR SELECTABLE

2700K-5000K + 2000K



LED ROUND CANLESS DOWNLIGHT GIMBAL

ASD-JBR-GB



355° LENS ROTATION AND 90° TILT RANGE



AIR TIGHT SOLUTION



5 COLOR TEMPERATURE OPTIONS

white



IC RATED CANLESS SOLUTION

black



120V voltage



PRODUCT SIZE

3", 4", 6"



AVAILABLE POWER

6W, 9W, 12W



COLOR SELECTABLE

2700K-5000K



LED ROUND WAFER BAFFLE TRIM

ASD-JBRB



LED ROUND WAFER FIRE RATED

ASD-JFR



BATTERY BACK-UP KIT

- MORE THAN 900lm IN EMERGENCY MODE FOR 90min
- AUTOMATIC SELF-TESTING

BATTERY BACK-UP KIT

- MORE THAN 900lm IN EMERGENCY MODE FOR 90min
- AUTOMATIC SELF-TESTING

- OPERATES ON 120-277V WITH 0-10V DIMMING
- 5 COLOR TEMPERATURE OPTIONS
- white
- HEAVY DUTY SPRING CLIPS WITH INCREASED HEIGHT
- AIR TIGHT AND IC RATED CANLESS SOLUTION
- black

- 2 HOUR FIRE RESISTANCE DUE TO REINFORCED AND HEAT RESISTANT STEEL BODY**
- CRI90+ RICH AND NATURAL COLORS
- white
- HEAVY DUTY COMMERCIAL GRADE SPRING CLIPS WITH INCREASED HEIGHT
- AIR TIGHT AND IC RATED CANLESS SOLUTION
- black

PRODUCT SIZE 4", 6"

AVAILABLE POWER 9W, 12W, 15W

COLOR SELECTABLE 5 CCT 2700K-5000K

120V voltage

120-277V voltage

PRODUCT SIZE 4", 6"

AVAILABLE POWER 12W, 15W

COLOR SELECTABLE 5 CCT 2700K-5000K

120V voltage

120-277V voltage



LED WAFER WITH DEEP BAFFLE TRIM

ASD-JBR-DB



DEEP BAFFLE TRIM



5 COLOR TEMPERATURE OPTIONS

white



CRI90+ RICH AND NATURAL COLORS



IC RATED CANLESS SOLUTION

black



120V voltage



PRODUCT SIZE

4", 6"



AVAILABLE POWER

10W, 15W



COLOR SELECTABLE

2700K-5000K

NEW CONSTRUCTION MOUNTING PLATE

ASD-MPL-FA WITH ASYMMETRIC HOLES

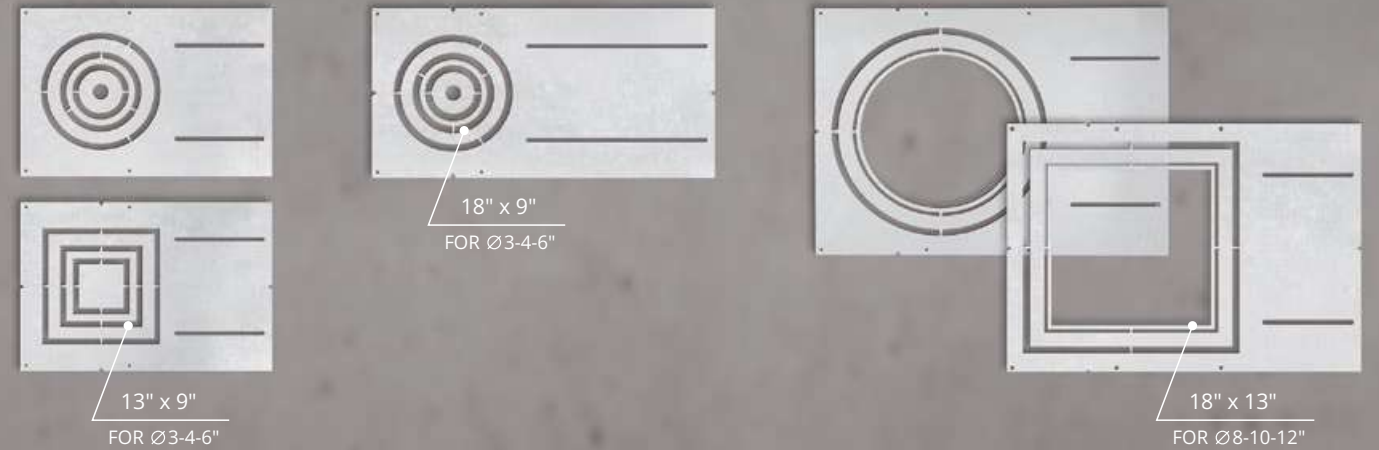

ASD-MPL-FS WITH SYMMETRIC HOLES

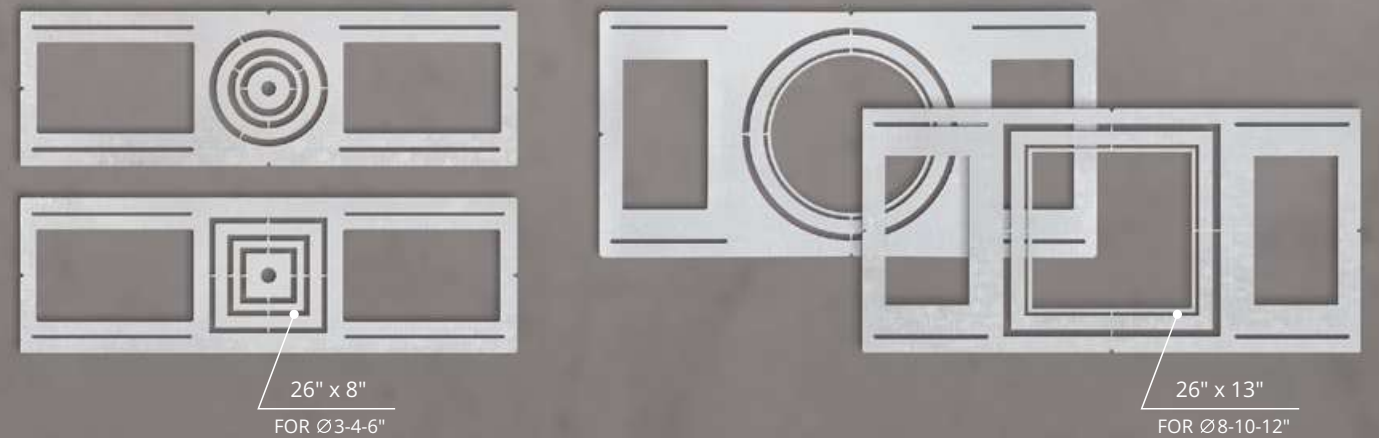

ASD-MPL-SC WITH SLIDING CLIPS

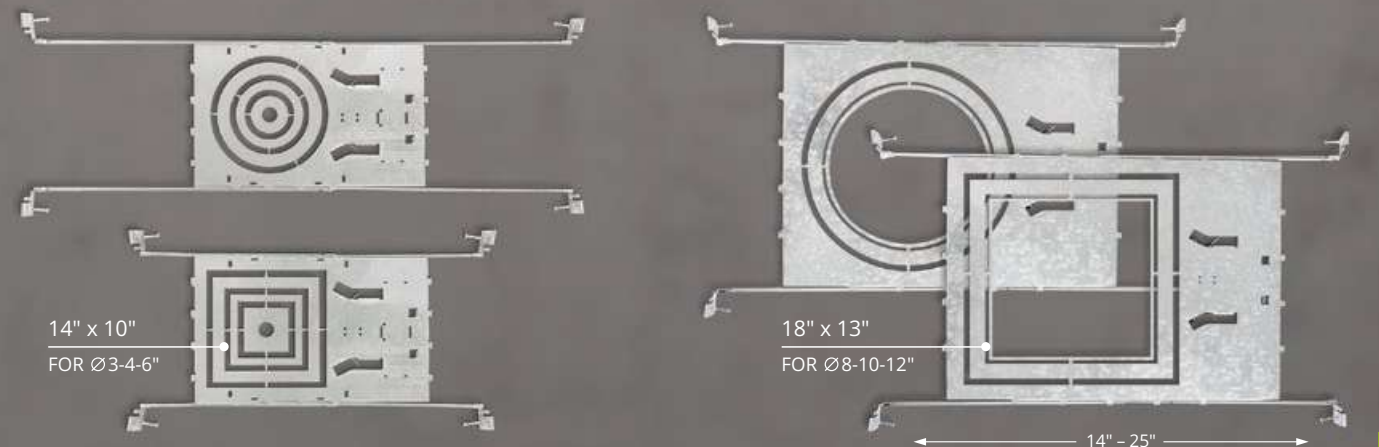

LED DOWNLIGHT RETROFIT KIT

ASD-LRK



LED DOWNLIGHT RETROFIT KIT GIMBAL

ASD-LRK-GB



PREINSTALLED TP24 AND E26 CONNECTORS FOR EASY INSTALLATION



5 COLOR TEMPERATURE OPTIONS

white

bronze



CRI90+ RICH AND NATURAL COLORS



WET LOCATIONS RATED

black



SWIVEL LENS WITH 25° TILT FOR DIRECTIONAL LIGHT CONTROL



5 COLOR TEMPERATURE OPTIONS

white



PREINSTALLED TP24 AND E26 CONNECTORS FOR EASY INSTALLATION



CRI90+ RICH AND NATURAL COLORS

bronze



PRODUCT SIZE

4", 6"



AVAILABLE POWER

8.6W, 10W, 12W



COLOR SELECTABLE

2700K-5000K



PRODUCT SIZE

4", 6"



AVAILABLE POWER

10W, 15W



COLOR SELECTABLE

2700K-5000K



LED VANITY LINEAR LOFT

ASD-LOFT-VF

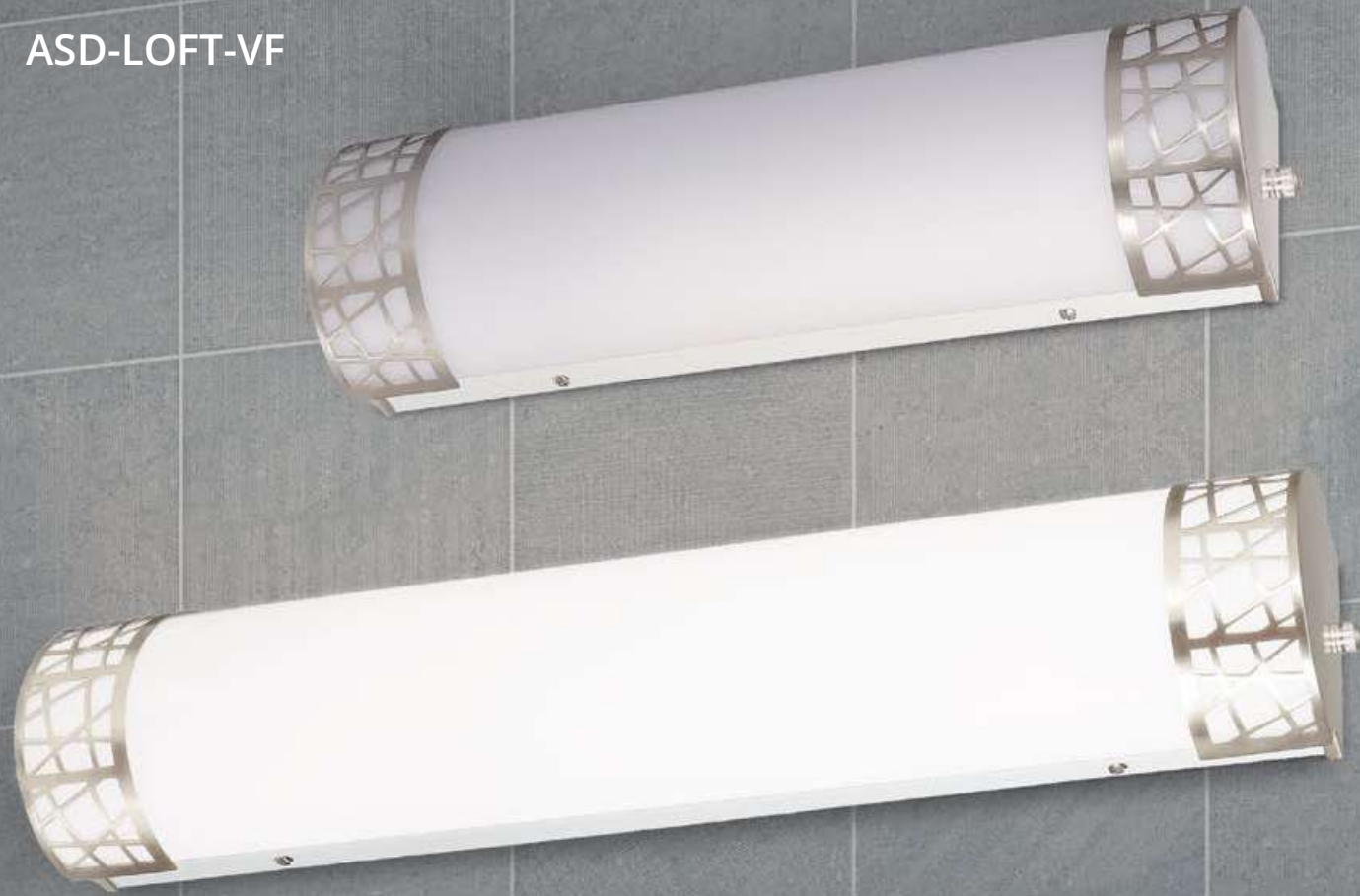

DURABLE HOUSING RESISTANT
TO RUST AND IMPACT



5 COLOR
TEMPERATURE OPTIONS



ACRYLIC LENS WITH EVEN
LIGHT DISTRIBUTION



SEAMLESS TRIAC DIMMING

LED VANITY LINEAR LIGHT

ASD-LVF21



DURABLE HOUSING RESISTANT
TO RUST AND IMPACT



5 COLOR
TEMPERATURE OPTIONS



ACRYLIC LENS WITH EVEN
LIGHT DISTRIBUTION



SEAMLESS TRIAC DIMMING



PRODUCT
SIZE

24", 36", 48"



AVAILABLE
POWER

25W, 30W, 35W



COLOR
SELECTABLE

2700K-5000K



PRODUCT
SIZE

18", 24", 36", 48"



AVAILABLE
POWER

20W-35W



COLOR
SELECTABLE

3000K-5000K



LED VANITY LINEAR LIGHT

ASD-LVF22



DURABLE HOUSING RESISTANT
TO RUST AND IMPACT



3 COLOR
TEMPERATURE OPTIONS



ACRYLIC LENS WITH EVEN
LIGHT DISTRIBUTION



SEAMLESS TRIAC DIMMING

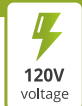

PRODUCT
SIZE
18", 24"



AVAILABLE
POWER
20W, 25W



COLOR
SELECTABLE
3000K-5000K



i 169
INFO PAGE

LED VANITY LINEAR LIGHT

ASD-LVF23



DURABLE HOUSING RESISTANT
TO RUST AND IMPACT



3 COLOR
TEMPERATURE OPTIONS



ACRYLIC LENS WITH EVEN
LIGHT DISTRIBUTION



SEAMLESS TRIAC DIMMING



PRODUCT
SIZE
18", 24", 36", 48"



AVAILABLE
POWER
20W, 25W, 30W, 35W



COLOR
SELECTABLE
3000K-5000K



i 169
INFO PAGE

LED VANITY LIGHT

ASD-LVF24M



VANITY LIGHT & MINI-PENDANT

ASD-VF44 VANITY LIGHT
ASD-MP44 MINI-PENDANT



DURABLE HOUSING RESISTANT TO RUST AND IMPACT



3 COLOR TEMPERATURE OPTIONS



chrome



ACRYLIC LENS WITH EVEN LIGHT DISTRIBUTION



SEAMLESS TRIAC DIMMING



black



DURABLE HOUSING RESISTANT TO RUST AND IMPACT



STANDARD E26 BASE IS COMPATIBLE WITH A VARIETY OF LED BULBS



nickel



OPAL GLASS SHADES WITH EVEN LIGHT DISTRIBUTION



QUICK AND EASY HARDWIRED INSTALLATION



black

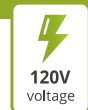

120V voltage



NUMBER OF LIGHTS

4, 6



AVAILABLE POWER

23W, 35W



COLOR SELECTABLE

3000K-5000K



NUMBER OF BULBS

1, 2, 3, 4



STANDARD BASE

E26



BULB TYPE

A19

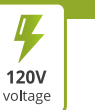

120V voltage

VANITY LIGHT & MINI-PENDANT

ASD-VF45 VANITY LIGHT
ASD-MP45 MINI-PENDANT



DURABLE HOUSING RESISTANT TO RUST AND IMPACT



STANDARD E26 BASE IS COMPATIBLE WITH A VARIETY OF LED BULBS



OPAL GLASS SHADES WITH EVEN LIGHT DISTRIBUTION



QUICK AND EASY HARDWIRED INSTALLATION

LED WALL SCONCE LOFT

ASD-LOFT-WS



DURABLE HOUSING RESISTANT TO RUST AND IMPACT



ACRYLIC LENS WITH EVEN LIGHT DISTRIBUTION



5 COLOR TEMPERATURE OPTIONS



SEAMLESS TRIAC DIMMING



NUMBER OF BULBS
1, 2, 3



STANDARD BASE
E26



BULB TYPE
A19



PRODUCT SIZE
12"



AVAILABLE POWER
15W



COLOR SELECTABLE
2700K-5000K



LED WALL SCONCE

ASD-LWS-11



DURABLE HOUSING RESISTANT TO RUST AND IMPACT

3 COLOR TEMPERATURE OPTIONS

nickel bronze

ACRYLIC LENS WITH EVEN LIGHT DISTRIBUTION

SEAMLESS TRIAC DIMMING

black

LED WALL SCONCE

ASD-LWS12



DURABLE HOUSING RESISTANT TO RUST AND IMPACT

5 COLOR TEMPERATURE OPTIONS

nickel

ACRYLIC LENS WITH EVEN LIGHT DISTRIBUTION

SEAMLESS TRIAC DIMMING

black

PRODUCT SIZE
10", 14", 18"

AVAILABLE POWER
15W, 20W

COLOR SELECTABLE
3000K-5000K

120V voltage

PRODUCT SIZE
8", 12", 14"

AVAILABLE POWER
10W, 12W, 24W

COLOR SELECTABLE
2700K-5000K

120V voltage

LED UNDER CABINET LINEAR LIGHT

ASD-UCL



HI/LO SWITCH PROVIDES 100% AND 50% BRIGHTNESS LEVELS

3 COLOR TEMPERATURE OPTIONS

CRI90+ RICH AND NATURAL COLORS

QUICK AND EASY HARDWARE AND PLUG-IN INSTALLATION



PRODUCT SIZE
12", 18", 24", 32", 40", 48"

AVAILABLE POWER
5W-24W

COLOR SELECTABLE
3 CCT 2700K-4000K



LED UNDER CABINET SWIVEL LIGHT

ASD-UCS



SWIVEL LENS WITH 50° TILT FOR DIRECTIONAL LIGHT CONTROL

3 COLOR TEMPERATURE OPTIONS

CRI90+ RICH AND NATURAL COLORS

QUICK AND EASY HARDWARE AND PLUG-IN INSTALLATION

white

bronze

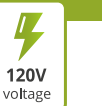

PRODUCT SIZE
12", 18", 24", 32", 40", 48"

AVAILABLE POWER
5W-24W

COLOR SELECTABLE
3 CCT 2700K-4000K



LED UNDER CABINET BULLNOSE LIGHT

ASD-UBN



ON / OFF SWITCH



CRI90+ RICH AND NATURAL COLORS



white



5 COLOR TEMPERATURE OPTIONS



QUICK AND EASY HARDWIRED INSTALLATION



bronze



PRODUCT SIZE

12", 18", 24", 32", 40", 48"



AVAILABLE POWER

5W-24W



COLOR SELECTABLE

2700K-5000K

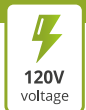

120V voltage

LED DOUBLE SIDE EXIT SIGN RED

ASD-ESD-RW



DOUBLE SIDE EXIT SIGN



FIRE-RESISTANT HOUSING



BUILT-IN 90 MINUTE BATTERY BACKUP



120/277V VOLTAGE

LED EDGE LIT TRANSPARENT EXIT SIGN RED

ASD-EXT-R



 TRANSPARENT EXIT SIGN

 120/277V VOLTAGE

 BUILT-IN 90 MINUTE BATTERY BACKUP

 DAMP LOCATION

LED EXIT SIGN RED WITH EMERGENCY LIGHTS

ASD-EXL-2SL
SQUARE HEADS



ASD-EXL-2RL
ROUND HEADS



 DOUBLE SIDE EXIT SIGN

 BUILT-IN 90 MINUTE BATTERY BACKUP

 TWO EMERGENCY LIGHTS 1.2W

 FIRE-RESISTANT HOUSING

LED EMERGENCY LIGHTS

ASD-EML-2SL
SQUARE HEADS



ASD-EML-2RL
ROUND HEADS



TWO ROTATABLE
EMERGENCY LIGHTS 1.2W

FIRE-RESISTANT HOUSING

BUILT-IN 90 MINUTE
BATTERY BACKUP

120-277V VOLTAGE

LED STEP LIGHT WITH RGBW

ASD-STLA-RGBW



PACKAGE CONTENTS



RGBW DESIGN
WITH 16.7 MILLION COLORS

LOW-PROFILE DESIGN
WITH NO VISIBLE HARDWARE

CONTROLLED BY SMART APP
ON YOUR SMARTPHONE

WATERPROOF
FOR ALL WEATHER CONDITIONS

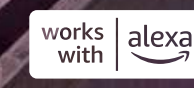

120V
voltage

AVAILABLE
POWER
3W

COLOR
CHANGING
2700K-6500K-RGBW



LED STEP LIGHT

ASD-LSTL



LOW-PROFILE DESIGN WITH NO VISIBLE HARDWARE



3 COLOR TEMPERATURE OPTIONS

white



DURABLE HOUSING RESISTANT TO RUST AND IMPACT



WATERPROOF FOR ALL WEATHER CONDITIONS

black



W AVAILABLE POWER
3W

3CCT COLOR SELECTABLE
3000K-5000K



BUILT-IN PHOTOCELL
ASD-LSTL-PC



BUILT-IN DUSK TO DAWN PHOTOCELL



AUTOMATICALLY SWITCHES ON/OFF DEPENDING ON THE TIME OF DAY



BUILT-IN MOTION SENSOR
ASD-LSTL-MS



BUILT-IN PIR MOTION SENSOR



DETECTION RANGE UP TO 13FT



BUILT-IN PHOTOCELL & MOTION SENSOR
ASD-LSTL-PC-MS



BUILT-IN DUSK TO DAWN PHOTOCELL



BUILT-IN PIR MOTION SENSOR



AUTOMATICALLY SWITCHES ON/OFF DEPENDING ON THE TIME OF DAY

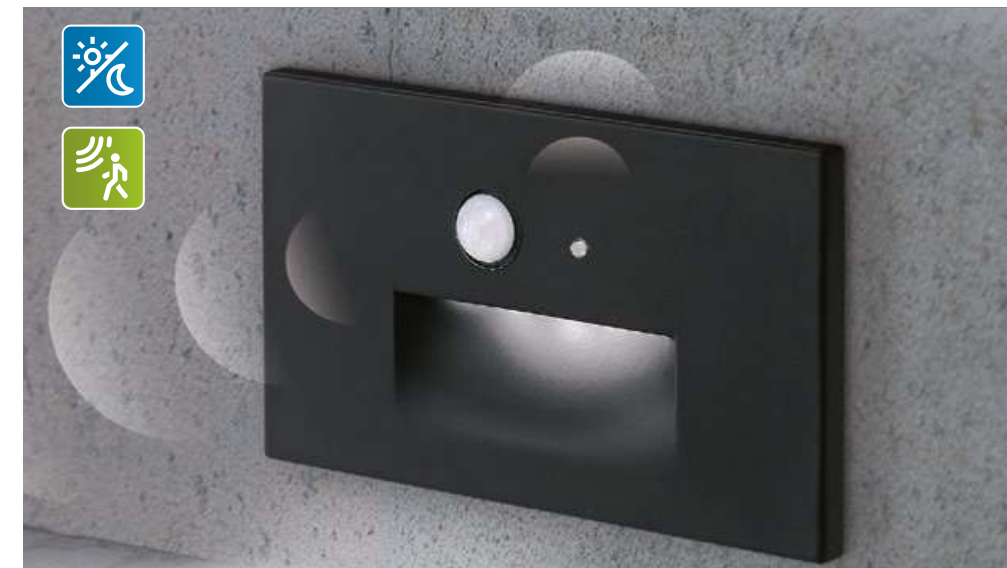

LED SWIVEL HARDSCAPE LIGHT

ASD-HSLS

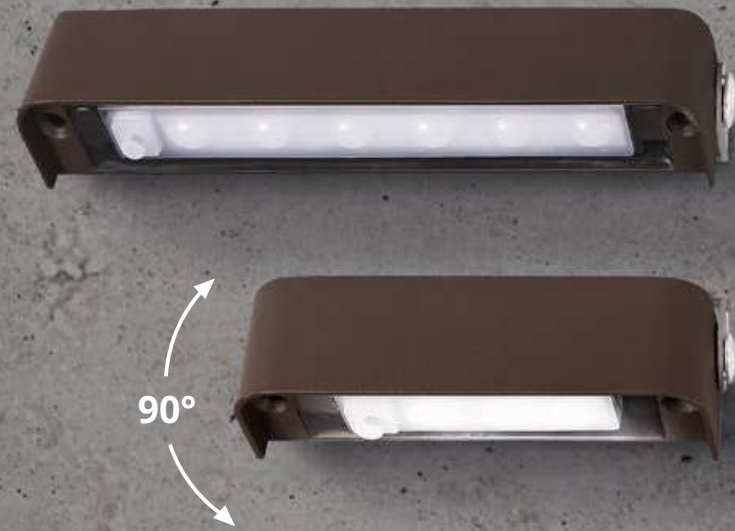

90°

12V
LOW-VOLTAGE DESIGN

5 COLOR
TEMPERATURE OPTIONS

90°
ADJUSTABLE LIGHT HEAD

CUTTABLE
MOUNTING PLATE

LED SWIVEL HARDSCAPE LIGHT WITH RGBW

ASD-HSLS-RGBW

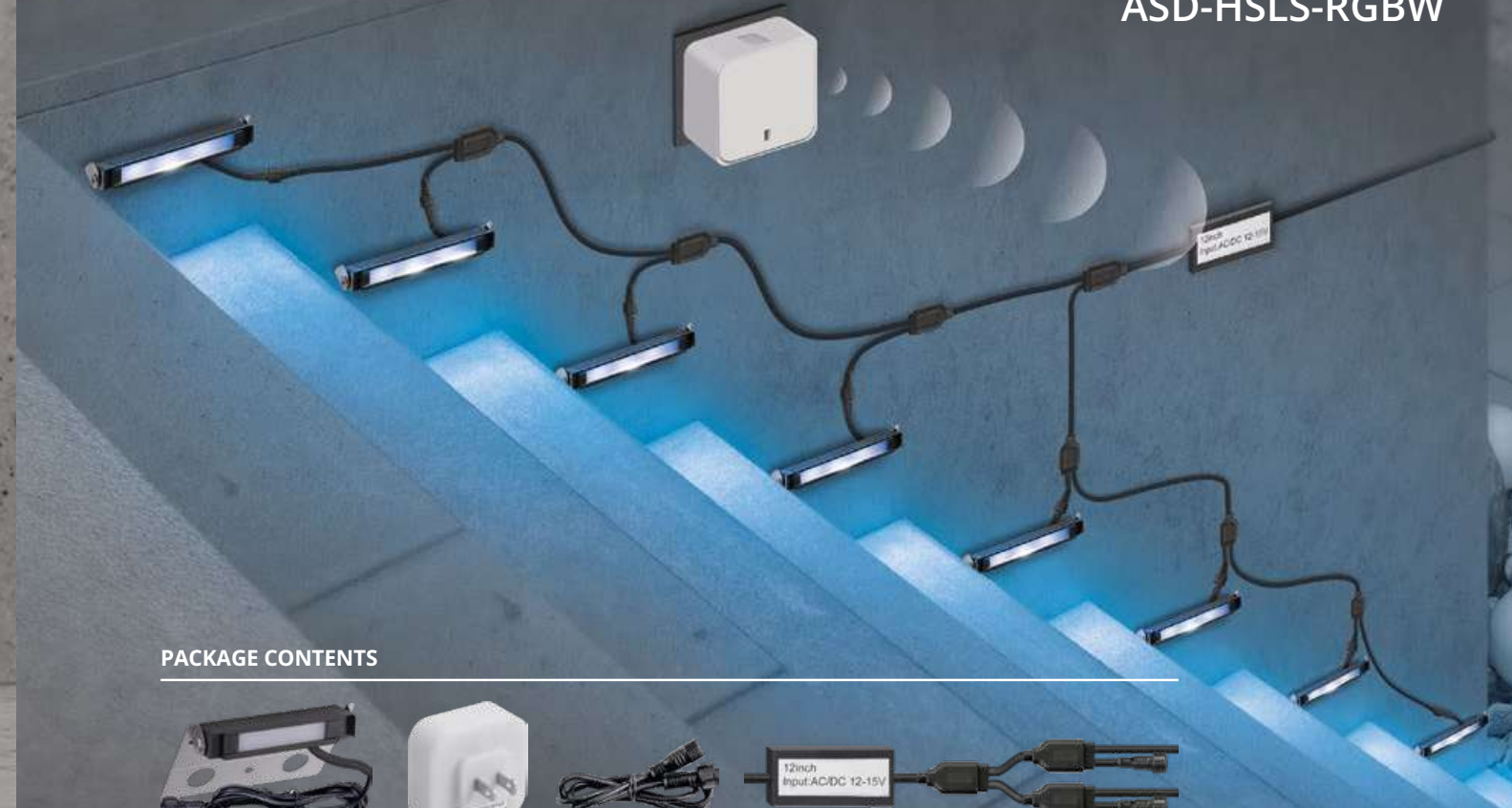

PACKAGE CONTENTS



LED HARDSCAPE LIGHT
with RGBW – 8PCS

SMART HUB

EXTENSION CORD –
2PCS X 40"

BLUETOOTH
CONTROLLER

RGBW DESIGN
WITH 16.7 MILLION COLORS

90°
ADJUSTABLE LIGHT HEAD

CONTROLLED BY SMART APP
ON YOUR SMARTPHONE

CUTTABLE
MOUNTING PLATE



**PRODUCT
SIZE**
4", 7", 12"

**AVAILABLE
POWER**
2W, 4.5W, 5W

**COLOR
SELECTABLE**
2200K-5000K



**PRODUCT
SIZE**
4", 7", 12"

**AVAILABLE
POWER**
1.5W, 3W, 5W

**COLOR
CHANGING**
2700K-6500K-RGBW



LED OUTDOOR WALL SCONCE

ASD-OLWS-21



DURABLE HOUSING RESISTANT TO RUST AND IMPACT



3 COLOR TEMPERATURE OPTIONS



nickel



bronze



UV RESISTANT PMMA LENS WITH EVEN LIGHT DISTRIBUTION



WATERPROOF FOR ALL WEATHER CONDITIONS



black

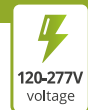

120-277V voltage



PRODUCT SIZE
10", 18", 24", 36"



AVAILABLE POWER
15W-30W



COLOR SELECTABLE
3000K-5000K



BUILT-IN PHOTOCELL
ASD-OLWS-21-PC



BUILT-IN DUSK TO DAWN PHOTOCELL



LIGHT LEVEL TO TURN ON 10-60 LUX, TO TURN OFF 300 LUX



DETECTION RANGE
MIN 27FT x 120+0/20°



BUILT-IN MOTION SENSOR
ASD-OLWS-21-MS



BUILT-IN INFRARED MOTION SENSOR



DETECTION RANGE
UP TO 26FT



OPERATING TIME
60 SECOND



INSTALLATION HEIGHT
3-6FT



WALL SCONCE WITH GRID
ASD-OLWS-21GR



PRODUCT SIZE
24", 36"



GRID DESIGN



UV RESISTANT PMMA LENS WITH GRID



LED OUTDOOR WALL SCONCE WITH RGBW

ASD-OLWS-21-RGBW



LED OUTDOOR WALL SCONCE

ASD-OLWS-22



CONTROLLED BY SMART APP ON YOUR SMARTPHONE



DURABLE HOUSING RESISTANT TO RUST AND IMPACT



RGBW DESIGN WITH 16.7 MILLION COLORS



DURABLE HOUSING RESISTANT TO RUST AND IMPACT



UV RESISTANT PMMA LENS WITH EVEN LIGHT DISTRIBUTION



3 COLOR TEMPERATURE OPTIONS



WATERPROOF FOR ALL WEATHER CONDITIONS



PRODUCT SIZE
10", 24"



AVAILABLE POWER
15W, 23W



COLOR CHANGING
2700K-6500K-RGBW



PRODUCT SIZE
12", 18", 24", 36"



AVAILABLE POWER
15W-28W



COLOR SELECTABLE
3000K-5000K



LED OUTDOOR WALL SCONCE

ASD-OLWS-23



BUILT-IN PHOTOCELL

- BUILT-IN DUSK TO DAWN PHOTOCELL
- AUTOMATICALLY SWITCHES ON/OFF DEPENDING ON THE TIME OF DAY

DURABLE HOUSING RESISTANT TO RUST AND IMPACT

UV RESISTANT PMMA LENS WITH EVEN LIGHT DISTRIBUTION

3 COLOR TEMPERATURE OPTIONS

WATERPROOF FOR ALL WEATHER CONDITIONS

120V voltage

PRODUCT SIZE
8", 14", 24"

AVAILABLE POWER
12W, 20W, 30W

COLOR SELECTABLE
3000K-5000K



173 INFO PAGE

LED OUTDOOR WALL SCONCE WITH RGBW

ASD-OLWS23-RGBW



CONTROLLED BY SMART APP ON YOUR SMARTPHONE

DURABLE HOUSING RESISTANT TO RUST AND IMPACT

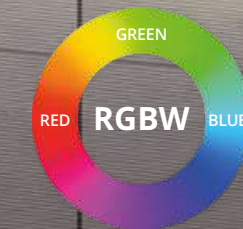

RGBW DESIGN WITH 16.7 MILLION COLORS



works with alexa

120-277V voltage

PRODUCT SIZE
8", 14", 24"

AVAILABLE POWER
12W, 20W, 30W

COLOR CHANGING
2700K-6500K-RGBW



173 INFO PAGE

LED OUTDOOR WALL SCONCE

ASD-LWS26S



BUILT-IN PHOTOCELL

- BUILT-IN DUSK TO DAWN PHOTOCELL
- AUTOMATICALLY SWITCHES ON/OFF DEPENDING ON THE TIME OF DAY

LED OUTDOOR WALL SCONCE WITH RGBW

ASD-LWS26-RGBW



DURABLE HOUSING RESISTANT TO RUST AND IMPACT

3 COLOR TEMPERATURE OPTIONS

white

CONTROLLED BY SMART APP ON YOUR SMARTPHONE

CLEAR SEEDED GLASS FOR LUXURIOUS GLOW

WATERPROOF FOR ALL WEATHER CONDITIONS

black

DURABLE HOUSING RESISTANT TO RUST AND IMPACT



RGBW DESIGN WITH 16.7 MILLION COLORS



PRODUCT SIZE
13", 18", 24"

AVAILABLE POWER
11.5W, 12W, 20W

3 CCT COLOR SELECTABLE
3000K-5000K

120V voltage

120-277V voltage

PRODUCT SIZE
18", 24"

AVAILABLE POWER
8.5W, 9W

5 CCT COLOR CHANGING
2700K-6500K-RGBW

120-277V voltage



LED OUTDOOR WALL SCONCE

ASD-LWS28S



LED OUTDOOR WALL SCONCE WITH RGBW

ASD-LWS28S-RGBW



MULTIDIRECTIONAL ILLUMINATION



3 COLOR TEMPERATURE OPTIONS



white



CLEAR SEEDED GLASS FOR LUXURIOUS GLOW



WATERPROOF FOR ALL WEATHER CONDITIONS



black



CONTROLLED BY SMART APP ON YOUR SMARTPHONE



DURABLE HOUSING RESISTANT TO RUST AND IMPACT



RGBW DESIGN WITH 16.7 MILLION COLORS



PRODUCT SIZE

12", 18", 24"



AVAILABLE POWER

22W



COLOR SELECTABLE

3000K-5000K

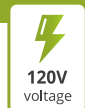

120V voltage



120-277V voltage



PRODUCT SIZE

18", 24"



AVAILABLE POWER

22W



COLOR CHANGING

2700K-6500K-RGBW



120-277V voltage

LED OUTDOOR WALL SCONCE WITH WIDE ACRYLIC

ASD-LWS27A



UP TO 6ft



LED OUTDOOR WALL SCONCE WITH WIDE ACRYLIC & RGBW

ASD-LWS27A-RGBW



UP TO 6ft



5-7/8"



DURABLE HOUSING RESISTANT TO RUST AND IMPACT



OPERATES ON 120-277V



3 COLOR TEMPERATURE OPTIONS



CAN BE INSTALLED ON 2.75" OR 3.5" J-BOX



CONTROLLED BY SMART APP ON YOUR SMARTPHONE



WATERPROOF FOR ALL WEATHER CONDITIONS

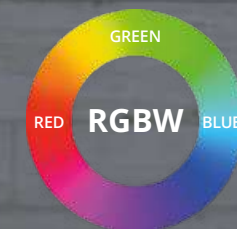

RGBW DESIGN WITH 16.7 MILLION COLORS



PRODUCT SIZE
18", 24", 36", 48", 72"



AVAILABLE POWER
18W-40W



COLOR SELECTABLE
3000K-5000K



120-277V voltage



i 174 INFO PAGE



PRODUCT SIZE
18", 24", 48", 72"



AVAILABLE POWER
12W-40W



COLOR CHANGING
2700K-6500K-RGBW



120-277V voltage



i 174 INFO PAGE

LED OUTDOOR NARROW WALL SCONCE

ASD-LWS27N



3-1/8"



UP TO 6ft



LED OUTDOOR NARROW WALL SCONCE WITH RGBW

ASD-LWS27N-RGBW



3-1/8"



NARROW DESIGN

OPERATES ON 120-277V

3 COLOR TEMPERATURE OPTIONS

CAN BE INSTALLED ON 2.75" OR 3.5" J-BOX

NARROW DESIGN

CONTROLLED BY SMART APP ON YOUR SMARTPHONE



RGBW DESIGN WITH 16.7 MILLION COLORS



PRODUCT SIZE
18", 24", 36", 48", 72"

AVAILABLE POWER
18W-40W

COLOR SELECTABLE
3000K-5000K



PRODUCT SIZE
24", 48"

AVAILABLE POWER
18W, 36W

COLOR CHANGING
2700K-6500K-RGBW



LED OUTDOOR WALL SCONCE WITH CENTER LIGHT

ASD-LWS27C



DURABLE HOUSING RESISTANT TO RUST AND IMPACT



OPERATES ON 120-277V



3 COLOR TEMPERATURE OPTIONS



CAN BE INSTALLED ON 2.75" OR 3.5" J-BOX

LED OUTDOOR WALL SCONCE WITH CENTER LIGHT & RGBW

ASD-LWS27C-RGBW

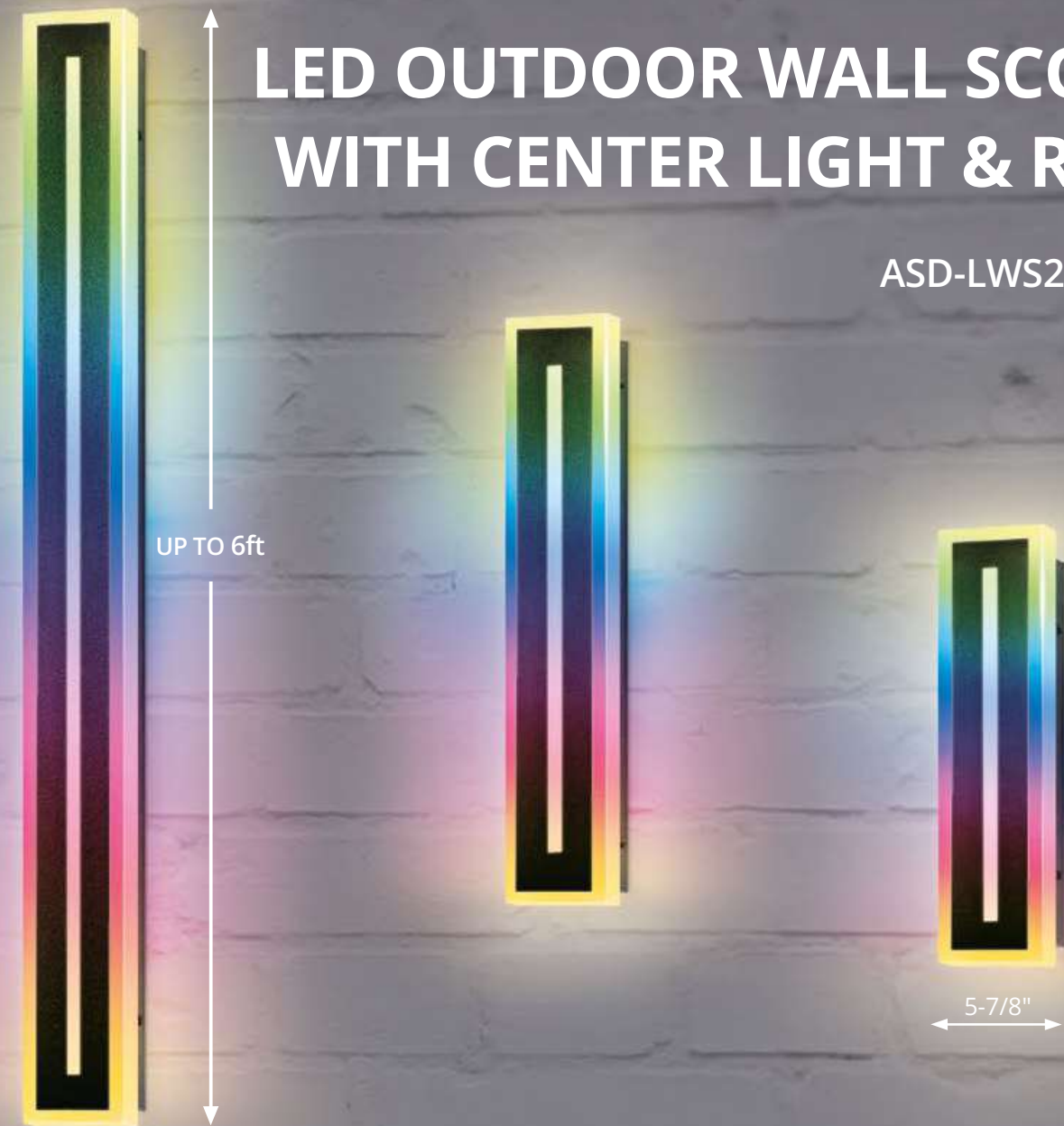

CONTROLLED BY SMART APP ON YOUR SMARTPHONE



WATERPROOF FOR ALL WEATHER CONDITIONS

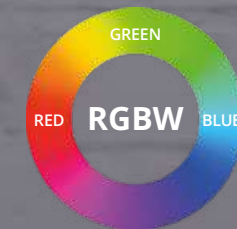

RGBW DESIGN WITH 16.7 MILLION COLORS



PRODUCT SIZE
18", 24", 36", 48", 72"



AVAILABLE POWER
18W-40W



COLOR SELECTABLE
3000K-5000K



120-277V voltage



i 174
INFO PAGE



PRODUCT SIZE
18", 24", 48", 72"



AVAILABLE POWER
20W-40W



COLOR CHANGING
2700K-6500K-RGBW



120-277V voltage



i 174
INFO PAGE

LED OUTDOOR BACK-LIGHT WALL SCONCE

ASD-LWS27B



3-1/8"



UP TO 6ft



BACK-LIGHT DESIGN



OPERATES ON 120-277V



3 COLOR TEMPERATURE OPTIONS



CAN BE INSTALLED ON 2.75" OR 3.5" J-BOX

LED ROUND OUTDOOR WALL CYLINDER WITH RGBW

ASD-LCLR2-RGBW



CONTROLLED BY SMART APP ON YOUR SMARTPHONE



WATERPROOF FOR ALL WEATHER CONDITIONS

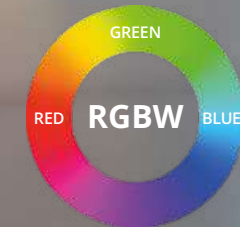

RGBW DESIGN WITH 16.7 MILLION COLORS



PRODUCT SIZE
18", 24", 36", 48", 72"



AVAILABLE POWER
18W-40W



COLOR SELECTABLE
3000K-5000K



LIGHT DIRECTION
2 sides



AVAILABLE POWER
30W



COLOR CHANGING
2700K-6500K-RGBW



LED OUTDOOR WALL CYLINDER

ASD-LCL-A

ASD-LCL-B
WITH DECORATIVE RINGS



EFFECTIVE UP AND DOWN ILLUMINATION



3 COLOR TEMPERATURE OPTIONS



DURABLE HOUSING RESISTANT TO RUST AND IMPACT



WATERPROOF FOR ALL WEATHER CONDITIONS



LIGHT DIRECTION

1 side, 2 sides



AVAILABLE POWER

9W, 18W



COLOR SELECTABLE

3000K-5000K



BUILT-IN PHOTOCELL

ASD-LCLR-A, ASD-LCLS-A



BUILT-IN DUSK TO DAWN PHOTOCELL



AUTOMATICALLY SWITCHES ON/OFF DEPENDING ON THE TIME OF DAY



BUILT-IN BATTERY BACK-UP

ASD-LCLR-EM



90 MINUTES OF POWER IN CASE OF EMERGENCY



BUILT-IN WORKING MODE INDICATOR



6W BATTERY BACK-UP POWER



WALL CYLINDER WITH DECORATIVE RINGS

ASD-LCLR-B, ASD-LCLS-B



1 OR 2 ACRYLIC DECORATIVE RINGS



SIDE-LIGHT EFFECT



A-TYPE CYLINDER

STANDARD ROUND



WITH PHOTOCELL ROUND



WITH BATTERY BACK-UP ROUND



WITH RGBW ROUND



SQUARE



SQUARE



B-TYPE CYLINDER

WITH DECORATIVE RINGS ROUND



SQUARE



BULB OUTDOOR WALL CYLINDER

ASD-OCL-A

ASD-OCL-B
WITH DECORATIVE RINGS

BUILT-IN PHOTOCELL

BUILT-IN DUSK TO DAWN PHOTOCELL

AUTOMATICALLY SWITCHES ON/OFF DEPENDING ON THE TIME OF DAY



A-TYPE CYLINDER STANDARD



WITH PHOTOCELL



B-TYPE CYLINDER WITH DECORATIVE RINGS

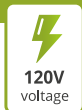

BULB OUTDOOR BOLLARD WITH DECORATIVE RING

ASD-BLC





LED LINEAR HIGH BAY WITH Q-BASE NEOX series

ASD-WHB5B-NEOX

Model	Size	Watts	Input Voltage	Dimmable	CCT	Lm	Dimensions LxWxH	Pcs. per Carton	Certification
ASD-WHB5B-NEOX-100	14"	60/80/100	120-277	0-10V	3,500/4,000/5,000	19,913	14-15/16" x 9-13/16" x 2-15/16"	1	UL / DLC PRM
ASD-WHB5B-NEOX-160	14"	100/130/160	120-277	0-10V	3,500/4,000/5,000	29,327	14-15/16" x 9-13/16" x 2-15/16"	1	UL / DLC PRM
ASD-WHB5B-NEOX-220	18"	130/160/220	120-277	0-10V	3,500/4,000/5,000	41,069	17-11/16" x 12-7/16" x 2-15/16"	1	UL / DLC PRM
ASD-WHB5B-NEOX-320	20"	160/220/320	120-277	0-10V	3,500/4,000/5,000	59,804	20-1/2" x 14-7/16" x 3-1/4"	1	UL / DLC PRM
ASD-WHB5B-NEOX-500	35"	320/400/500	120-277	0-10V	3,500/4,000/5,000	94,103	35-1/2" x 12-7/16" x 2-15/16"	1	UL / DLC PRM

HIGH VOLTAGE

Model	Size	Watts	Input Voltage	Dimmable	CCT	Lm	Dimensions LxWxH	Pcs. per Carton	Certification
ASD-WHB5BHV-NEOX-220	18"	130/160/220	200-480	0-10V	3,500/4,000/5,000	40,770	17-11/16" x 12-7/16" x 2-15/16"	1	UL / DLC PRM
ASD-WHB5BHV-NEOX-320	20"	160/220/320	200-480	0-10V	3,500/4,000/5,000	58,552	20-1/2" x 14-7/16" x 3-1/4"	1	UL / DLC PRM
ASD-WHB5BHV-NEOX-500	35"	320/400/500	200-480	0-10V	3,500/4,000/5,000	93,694	35-1/2" x 12-7/16" x 2-15/16"	1	UL / DLC PRM

ACCESSORIES

Infrared Motion Sensor 3pin 39ft White	ASD-09IR-WH	2-1/8" x 2-1/8" x 1-11/16"	120	UL
Infrared Motion Sensor 3pin 50ft White	ASD-09IR50-WH	2-1/8" x 2-1/8" x 1-11/16"	120	UL
Microwave Motion Sensor 3pin 49ft White	ASD-09MW-WH	2-1/8" x 2-1/8" x 1-5/16"	120	UL
Remote Control for Motion Sensor	ASD-06RC	5-11/16" x 1-3/4" x 13/16"	60	-
Battery back-up kit 20W 120-277V	ASD-EMK20W-WHB5B	9-5/8" x 4-5/8" x 1-7/8"	10	-
Battery back-up kit 30W 120-277V	ASD-EMK30W-WHB5A	9-5/8" x 4-5/8" x 1-7/8"	10	-
Pendant Mounting Bracket for 100-220W	ASD-PMB1-WHB5	4" x 3-11/16" x 3-1/8"	50	-
Surface Mounting Bracket	ASD-SMB1-WHB5	4" x 3-11/16" x 3-1/16"	50	-
60° Clear Lens for 220W	ASD-L60-220-WHB5B	17-9/16" x 3-7/8" x 3/8"	20	-
60° Clear Lens for 320W	ASD-L60-320-WHB5B	20-5/16" x 4-13/16" x 3/8"	20	-

LED LINEAR HIGH BAY WITH Q-BASE STANDARD series

ASD-WHB5B-ST

Model	Size	Watts	Input Voltage	Dimmable	CCT	Lm	Beam Angle	Dimensions LxWxH	Pcs. per Carton	Certification
ASD-WHB5B-ST-100	14"	60/80/100	120-277	0-10V	3,500/4,000/5,000	16,366	90°	14-15/16" x 9-13/16" x 2-15/16"	1	UL / DLC PRM
ASD-WHB5B-ST-160	14"	100/130/160	120-277	0-10V	3,500/4,000/5,000	25,522	90°	14-15/16" x 9-13/16" x 2-15/16"	1	UL / DLC PRM
ASD-WHB5B-ST-220	18"	130/160/220	120-277	0-10V	3,500/4,000/5,000	36,274	90°	17-11/16" x 12-7/16" x 2-15/16"	1	UL / DLC PRM
ASD-WHB5B-ST-320	20"	160/220/320	120-277	0-10V	3,500/4,000/5,000	52,194	90°	20-1/2" x 14-7/16" x 3-1/4"	1	UL / DLC PRM
ASD-WHB5B-ST-500	35"	320/400/500	120-277	0-10V	3,500/4,000/5,000	76,668	90°	35-1/2" x 12-7/16" x 2-15/16"	1	UL / DLC PRM
ASD-WHB5B-ST-750	41"	500/650/750	120-277	0-10V	3,500/4,000/5,000	114,114	90°	41" x 14-7/16" x 3-1/4"	1	UL / DLC PRM

HIGH VOLTAGE

ASD-WHB5BHV-ST-220	18"	130/160/220	200-480	0-10V	3,500/4,000/5,000	34,386	90°	17-11/16" x 12-7/16" x 2-15/16"	1	UL / DLC PRM
ASD-WHB5BHV-ST-320	20"	160/220/320	200-480	0-10V	3,500/4,000/5,000	51,262	90°	20-1/2" x 14-7/16" x 3-1/4"	1	UL / DLC PRM
ASD-WHB5BHV-ST-500	35"	160/220/320	200-480	0-10V	3,500/4,000/5,000	81,220	90°	35-1/2" x 12-7/16" x 2-15/16"	1	UL / DLC PRM

WITH BATTERY BACK-UP

ASD-WHB5B-ST-160-40EM	14"	100/130/160	120-277	0-10V	3,500/4,000/5,000	25,522	90°	14-15/16" x 9-13/16" x 5-9/16"	1	UL / DLC PRM
ASD-WHB5B-ST-220-40EM	18"	130/160/220	120-277	0-10V	3,500/4,000/5,000	36,274	90°	17-11/16" x 12-7/16" x 5-9/16"	1	UL / DLC PRM

ACCESSORIES

Infrared Motion Sensor 3pin 39ft White	ASD-09IR-WH	2-1/8" x 2-1/8" x 1-11/16"	120	UL
Infrared Motion Sensor 3pin 50ft White	ASD-09IR50-WH	2-1/8" x 2-1/8" x 1-11/16"	120	UL
Microwave Motion Sensor 3pin 49ft White	ASD-09MW-WH	2-1/8" x 2-1/8" x 1-5/16"	120	UL
Remote Control for Motion Sensor	ASD-06RC	5-11/16" x 1-3/4" x 13/16"	60	-
Battery back-up kit 20W 120-277V	ASD-EMK20W-WHB5B	9-5/8" x 4-5/8" x 1-7/8"	10	-
Battery back-up kit 30W 120-277V	ASD-EMK30W-WHB5A	9-5/8" x 4-5/8" x 1-7/8"	10	-
Pendant Mounting Bracket for 100-220W	ASD-PMB1-WHB5	4" x 3-11/16" x 3-1/8"	50	-
Surface Mounting Bracket	ASD-SMB1-WHB5	4" x 3-11/16" x 3-1/16"	50	-
60° Clear Lens for 220W	ASD-L60-220-WHB5B	17-9/16" x 3-7/8" x 3/8"	20	-
60° Clear Lens for 320W	ASD-L60-320-WHB5B	20-5/16" x 4-13/16" x 3/8"	20	-



LED LINEAR BEAM ANGLE ADJUSTABLE HIGH BAY WITH Q-BASE STANDARD series

ASD-WHB5B-ST-BA

Model	Size	Watts	Input Voltage	Dimmable	CCT	Lm	Beam Angle	Dimensions LxWxH	Pcs. per Carton	Certification
ASD-WHB5B-ST-220-BA	24"	130/160/220	120-277	0-10V	3,500/4,000/5,000	37,125	45/60/90°	23-7/8" x 13-1/8" x 2-15/16"	1	UL / DLC PRM
ASD-WHB5B-ST-320-BA	33"	160/220/320	120-277	0-10V	3,500/4,000/5,000	53,985	45/60/90°	33-1/8" x 13-1/4" x 2-13/16"	1	UL / DLC PRM

ACCESSORIES

Infrared Motion Sensor 3pin 39ft White	ASD-09IR-WH	2-1/8" x 2-1/8" x 1-11/16"	120	UL
Infrared Motion Sensor 3pin 50ft White	ASD-09IR50-WH	2-1/8" x 2-1/8" x 1-11/16"	120	UL
Microwave Motion Sensor 3pin 49ft White	ASD-09MW-WH	2-1/8" x 2-1/8" x 1-5/16"	120	UL
Remote Control for Motion Sensor	ASD-06RC	5-11/16" x 1-3/4" x 13/16"	60	-
Battery back-up kit 20W 120-277V	ASD-EMK20W-WHB5B	9-5/8" x 4-5/8" x 1-7/8"	10	-
Battery back-up kit 30W 120-277V	ASD-EMK30W-WHB5A	9-5/8" x 4-5/8" x 1-7/8"	10	-
Pendant Mounting Bracket for 100-220W	ASD-PMB1-WHB5	4" x 3-11/16" x 3-1/8"	50	-
Surface Mounting Bracket	ASD-SMB1-WHB5	4" x 3-11/16" x 3-1/16"	50	-

SMART RGBW FULL SURFACE LINEAR HIGH BAY

ASD-WHB7-RGBW

Model	Size	Watts	Input Voltage	Dimmable	CCT	Lm	Dimensions LxWxH	Pcs. per Carton	Certification
ASD-WHB7-160RGBW	24"	160	120-277	SMART APP	3,500-5,000+RGBW	19,156	23-5/8" x 11-13/16" x 2-7/8"	1	UL
ASD-WHB7-220RGBW	33"	220	120-277	SMART APP	3,500-5,000+RGBW	26,385	32-11/16" x 11-13/16" x 3"	1	UL

ACCESSORIES

Pendant Mounting Bracket for 100-220W	ASD-PMB1-WHB5	4" x 3-11/16" x 3-1/8"	50	-
Surface Mounting Bracket for	ASD-SMB1-WHB5	4" x 3-11/16" x 3-1/16"	50	-

LED LINEAR NARROW HIGH BAY WITH Q-BASE STANDARD series

ASD-NHB-ST

Model	Size	Watts	Input Voltage	Dimmable	CCT	Lm	Dimensions LxWxH	Pcs. per Carton	Certification
ASD-NHB-ST-160	30"	100/130/160	120-277	0-10V	3,500/4,000/5,000	26,100	29-15/16" x 4-11/16" x 3-5/16"	1	UL / DLC PRM
ASD-NHB-ST-220	30"	130/160/220	120-277	0-10V	3,500/4,000/5,000	34,331	30-7/8" x 7-5/8" x 3-3/8"	1	UL / DLC PRM
ASD-NHB-ST-320	30"	160/220/320	120-277	0-10V	3,500/4,000/5,000	51,952	30-7/8" x 7-5/8" x 3-3/8"	1	UL / DLC PRM

WITH BATTERY BACK-UP

ASD-NHB-ST-220-40EM	33"	130/160/220	120-277	0-10V	3,500/4,000/5,000	34,331	32-13/16" x 7-5/8" x 5-11/16"	1	UL / DLC PRM
---------------------	-----	-------------	---------	-------	-------------------	--------	-------------------------------	---	--------------

ACCESSORIES

Side Infrared Motion Sensor 3pin 39ft White	ASD-S10IR-WH	3-3/4" x 2-3/8" x 2-1/2"	120	UL
Remote Control for Motion Sensor	ASD-06RC	5-11/16" x 1-3/4" x 13/16"	60	-



LED UFO HIGH BAY WITH Q-BASE NEOX series

ASD-UHB2A-NEOX

Model	Watts	Input Voltage	Dimmable	CCT	Lm	Finish	Dimensions LxWxH	Pcs. per Carton	Certification
ASD-UHB2A-NEOX-150BK	100/120/150	120-277	0-10V	3,000/4,000/5,000	28,090	Black	10-1/4" x 10-1/4" x 4-11/16"	1	UL / DLC PRM
ASD-UHB2A-NEOX-150WH	100/120/150	120-277	0-10V	3,000/4,000/5,000	28,090	White	10-1/4" x 10-1/4" x 4-11/16"	1	UL / DLC PRM
ASD-UHB2A-NEOX-200BK	100/150/200	120-277	0-10V	3,000/4,000/5,000	37,829	Black	11-5/8" x 11-5/8" x 4-13/16"	1	UL / DLC PRM
ASD-UHB2A-NEOX-200WH	100/150/200	120-277	0-10V	3,000/4,000/5,000	37,829	White	11-5/8" x 11-5/8" x 4-13/16"	1	UL / DLC PRM
ASD-UHB2A-NEOX-240BK	150/200/240	120-277	0-10V	3,000/4,000/5,000	43,387	Black	11-5/8" x 11-5/8" x 5"	1	UL / DLC PRM
ASD-UHB2A-NEOX-240WH	150/200/240	120-277	0-10V	3,000/4,000/5,000	43,387	White	11-5/8" x 11-5/8" x 5"	1	UL / DLC PRM
ASD-UHB2A-NEOX-300BK	200/240/300	120-277	0-10V	3,000/4,000/5,000	54,539	Black	12-5/8" x 12-5/8" x 5-9/16"	1	UL / DLC PRM
ASD-UHB2A-NEOX-300WH	200/240/300	120-277	0-10V	3,000/4,000/5,000	54,539	White	12-5/8" x 12-5/8" x 5-9/16"	1	UL / DLC PRM
ASD-UHB2A-NEOX-500BK	300/400/500	120-277	0-10V	3,000/4,000/5,000	91,082	Black	14-7/16" x 14-7/16" x 7-1/8"	1	UL / DLC PRM

HIGH VOLTAGE

ASD-UHB2AHV-NEOX-150BK	100/120/150	200-480	0-10V	3,000/4,000/5,000	28,203	Black	10-1/4" x 10-1/4" x 4-11/16"	1	UL / DLC PRM
ASD-UHB2AHV-NEOX-200BK	100/150/200	200-480	0-10V	3,000/4,000/5,000	37,561	Black	11-5/8" x 11-5/8" x 4-13/16"	1	UL / DLC PRM
ASD-UHB2AHV-NEOX-240BK	150/200/240	200-480	0-10V	3,000/4,000/5,000	43,582	Black	11-5/8" x 11-5/8" x 5"	1	UL / DLC PRM
ASD-UHB2AHV-NEOX-300BK	200/240/300	200-480	0-10V	3,000/4,000/5,000	54,664	Black	12-5/8" x 12-5/8" x 5-9/16"	1	UL / DLC PRM
ASD-UHB2AHV-NEOX-500BK	300/400/500	200-480	0-10V	3,000/4,000/5,000	91,264	Black	14-9/16" x 14-9/16" x 8-1/16"	1	UL / DLC PRM

ACCESSORIES

Infrared Motion Sensor 3pin 39ft	ASD-09IR-WH	White	2-1/8" x 2-1/8" x 1-11/16"	120	UL
Infrared Motion Sensor 3pin 39ft	ASD-09IR-BK	Black	2-1/8" x 2-1/8" x 1-11/16"	120	UL
Infrared Motion Sensor 3pin 50ft	ASD-09IR50-WH	White	2-1/8" x 2-1/8" x 1-11/16"	120	UL
Microwave Motion Sensor 3pin 49ft	ASD-09MW-WH	White	2-1/8" x 2-1/8" x 1-5/16"	120	UL
Microwave Motion Sensor 3pin 49ft	ASD-09IR-BK	Black	2-1/8" x 2-1/8" x 1-5/16"	120	UL
Remote Control for Motion Sensor	ASD-06RC	-	5-11/16" x 1-3/4" x 13/16"	60	-
Battery Back-up kit 40W 120-277V	BLD-RM40R	-	15-11/16" x 15-11/16" x 5-9/16"	4	UL
Battery Back-up kit 40W 120-277V	ASD-EMB40	-	8-3/8" x 5-3/16" x 4-13/16"	6	UL
Battery Back-up kit 60W 120-277V	BLD-RM60R	-	15-11/16" x 5-3/4" x 5-3/4"	4	UL
Battery Back-up kit 60W 120-277V	ASD-EMB60	-	8-3/8" x 5-3/16" x 4-13/16"	6	UL
Battery Back-up kit 60W 277-480V	BLD-GM60R-HV	-	14-1/2" x 3-1/16" x 1-7/8"	5	UL
Remote Control for Battery Back-up kit	RN1	-	5-1/8" x 1-1/4" x 5/8"	50	-
Spring Hook M10 for 100-240W	ASD-H-M10	Metallic	3-5/16" x 2-1/16" x 7/8"	50	UL
Spring Hook M10 for 300W	ASD-H-M12	Metallic	3-1/2" x 2-5/16" x 1"	50	UL
Screw-bolt Hook M10 for 100-240W	ASD-HS-M10	Black	3-7/8" x 1-5/8" x 1-5/16"	50	UL
Pendant Mount Bracket	ASD-PMB-UHB	Black	2-3/8" x 1-9/16" x 2-13/16"	50	-
Pendant Mount Bracket with J-box and Spring Hook	ASD-PMBJB-UHB	Black	4-3/4" x 5-1/16" x 7-3/16"	40	-
Surface Mount Bracket for 150-300W	ASD-SMB-UHB2A-BK	Black	10-5/8" x 10-5/8" x 8-1/4"	20	-
Surface Mount Bracket for 150-300W	ASD-SMB-UHB2A-WH	White	10-5/8" x 10-5/8" x 8-1/4"	20	-
Clear Lens 60" for 150-240W	ASD-L60C-UHB2A	Clear	8-11/16" x 8-11/16" x 7/16"	20	-
Clear Lens 60" for 300W	ASD-L60B-UHB2A	Clear	11-5/16" x 11-5/16" x 1/2"	20	-
Clear Lens 60" for 500W	ASD-L60E-UHB2A	Clear	13-15/16" x 13-15/16" x 5/16"	20	-

LED UFO HIGH BAY WITH Q-BASE STANDARD series

ASD-UHB2A-ST-BA

Model	Watts	Input Voltage	Dimmable	CCT	Lm	Finish	Beam Angle	Dimensions LxWxH	Pcs. per Carton	Certification
ASD-UHB2A-ST-200BK-BA	100/150/200	120-277	0-10V	3,500/4,000/5,000	32,012	Black	60/90/110°	12-5/8" x 12-5/8" x 6-7/16"	1	UL / DLC PRM
ASD-UHB2A-ST-240BK-BA	150/200/240	120-277	0-10V	3,500/4,000/5,000	36,452	Black	60/90/110°	12-13/16" x 12-13/16" x 6-9/16"	1	UL / DLC PRM

ACCESSORIES

Infrared Motion Sensor 3pin 39ft	ASD-09IR-WH	White	2-1/8" x 2-1/8" x 1-11/16"	120	UL
Infrared Motion Sensor 3pin 39ft	ASD-09IR-BK	Black	2-1/8" x 2-1/8" x 1-11/16"	120	UL
Infrared Motion Sensor 3pin 50ft	ASD-09IR50-WH	White	2-1/8" x 2-1/8" x 1-11/16"	120	UL
Microwave Motion Sensor 3pin 49ft	ASD-09MW-WH	White	2-1/8" x 2-1/8" x 1-5/16"	120	UL
Microwave Motion Sensor 3pin 49ft	ASD-09IR-BK	Black	2-1/8" x 2-1/8" x 1-5/16"	120	UL
Remote Control for Motion Sensor	ASD-06RC	-	5-11/16" x 1-3/4" x 13/16"	60	-
Battery Back-up kit 40W 120-277V	BLD-RM40R	-	15-11/16" x 15-11/16" x 5-9/16"	4	UL
Battery Back-up kit 40W 120-277V	ASD-EMB40	-	8-3/8" x 5-3/16" x 4-13/16"	6	UL
Battery Back-up kit 60W 120-277V	BLD-RM60R	-	15-11/16" x 5-3/4" x 5-3/4"	4	UL
Battery Back-up kit 60W 120-277V	ASD-EMB60	-	8-3/8" x 5-3/16" x 4-13/16"	6	UL
Remote Control for Battery Back-up kit	RN1	-	5-1/8" x 1-1/4" x 5/8"	50	-
Spring Hook M10 for 100-240W	ASD-H-M10	Metallic	3-5/16" x 2-1/16" x 7/8"	50	UL
Screw-bolt Hook M10 for 100-240W	ASD-HS-M10	Black	3-7/8" x 1-5/8" x 1-5/16"	50	UL
Pendant Mount Bracket	ASD-PMB-UHB	Black	2-3/8" x 1-9/16" x 2-13/16"	50	-
Pendant Mount Bracket with J-box and Spring Hook	ASD-PMBJB-UHB	Black	4-3/4" x 5-1/16" x 7-3/16"	40	-
Surface Mount Bracket for 150-300W	ASD-SMB-UHB2A-BK	Black	10-5/8" x 10-5/8" x 8-1/4"	20	-



LED UFO HIGH BAY WITH Q-BASE STANDARD series

ASD-UHB2A-ST

Model	Watts	Input Voltage	Dimmable	CCT	Lm	Finish	Beam Angle	Dimensions LxWxH	Pcs. per Carton	Certification
ASD-UHB2A-ST-150BK	100/120/150	120-277	0-10V	3,000/4,000/5,000	23,610	Black	90°	10-1/4" x 10-1/4" x 4-11/16"	1	UL / DLC PRM
ASD-UHB2A-ST-150WH	100/120/150	120-277	0-10V	3,000/4,000/5,000	23,610	White	90°	10-1/4" x 10-1/4" x 4-11/16"	1	UL / DLC PRM
ASD-UHB2A-ST-200BK	100/150/200	120-277	0-10V	3,000/4,000/5,000	31,946	Black	90°	11-5/8" x 11-5/8" x 4-13/16"	1	UL / DLC PRM
ASD-UHB2A-ST-200WH	100/150/200	120-277	0-10V	3,000/4,000/5,000	31,946	White	90°	11-5/8" x 11-5/8" x 4-13/16"	1	UL / DLC PRM
ASD-UHB2A-ST-240BK	150/200/240	120-277	0-10V	3,000/4,000/5,000	37,646	Black	90°	11-5/8" x 11-5/8" x 5"	1	UL / DLC PRM
ASD-UHB2A-ST-240WH	150/200/240	120-277	0-10V	3,000/4,000/5,000	37,646	White	90°	11-5/8" x 11-5/8" x 5"	1	UL / DLC PRM
ASD-UHB2A-ST-300BK	200/240/300	120-277	0-10V	3,000/4,000/5,000	47,788	Black	90°	12-5/8" x 12-5/8" x 5-3/16"	1	UL / DLC PRM
ASD-UHB2A-ST-300WH	200/240/300	120-277	0-10V	3,000/4,000/5,000	47,788	White	90°	12-5/8" x 12-5/8" x 5-3/16"	1	UL / DLC PRM
ASD-UHB2A-ST-500BK	300/400/500	120-277	0-10V	3,000/4,000/5,000	78,273	Black	90	14-7/16" x 14-7/16" x 7-1/8"	1	UL / DLC PRM

HIGH VOLTAGE

ASD-UHB2AHV-ST-150BK	100/120/150	200-480	0-10V	3,000/4,000/5,000	23,638	Black	90°	10-1/4" x 10-1/4" x 4-11/16"	1	UL / DLC PRM
ASD-UHB2AHV-ST-200BK	100/150/200	200-480	0-10V	3,000/4,000/5,000	31,946	Black	90°	11-5/8" x 11-5/8" x 4-13/16"	1	UL / DLC PRM
ASD-UHB2AHV-ST-240BK	150/200/240	200-480	0-10V	3,000/4,000/5,000	37,738	Black	90°	11-5/8" x 11-5/8" x 5"	1	UL / DLC PRM
ASD-UHB2AHV-ST-300BK	200/240/300	200-480	0-10V	3,000/4,000/5,000	48,935	Black	90°	12-5/8" x 12-5/8" x 5-3/16"	1	UL / DLC PRM
ASD-UHB2AHV-ST-500BK	300/400/500	200-480	0-10V	3,000/4,000/5,000	77,718	Black	90°	14-9/16" x 14-9/16" x 8-1/16"	1	UL / DLC PRM
ASD-UHB2AHV-ST-750BK	500/600/750	200-480	0-10V	3,000/4,000/5,000	127,748	Black	90°	18-3/16" x 16-7/16" x 19"	1	UL / DLC PRM
ASD-UHB2AHV-ST-1000BK	500/750/1000	200-480	0-10V	3,000/4,000/5,000	170,912	Black	90	18-3/16" x 16-7/16" x 24-5/8"	1	UL / DLC PRM

ACCESSORIES

Infrared Motion Sensor 3pin 39ft	ASD-09IR-WH	White	2-1/8" x 2-1/8" x 1-11/16"	120	UL
Infrared Motion Sensor 3pin 39ft	ASD-09IR-BK	Black	2-1/8" x 2-1/8" x 1-11/16"	120	UL
Infrared Motion Sensor 3pin 50ft	ASD-09IR50-WH	White	2-1/8" x 2-1/8" x 1-11/16"	120	UL
Microwave Motion Sensor 3pin 49ft	ASD-09MW-WH	White	2-1/8" x 2-1/8" x 1-5/16"	120	UL
Microwave Motion Sensor 3pin 49ft	ASD-09IR-BK	Black	2-1/8" x 2-1/8" x 1-5/16"	120	UL
Remote Control for Motion Sensor	ASD-06RC	-	5-11/16" x 1-3/4" x 13/16"	60	-
Battery Back-up kit 40W 120-277V	BLD-RM40R	-	15-11/16" x 15-11/16" x 5-9/16"	4	UL
Battery Back-up kit 40W 120-277V	ASD-EMB40	-	8-3/8" x 5-3/16" x 4-13/16"	6	UL
Battery Back-up kit 60W 120-277V	BLD-RM60R	-	15-11/16" x 5-3/4" x 5-3/4"	4	UL
Battery Back-up kit 60W 120-277V	ASD-EMB60	-	8-3/8" x 5-3/16" x 4-13/16"	6	UL
Battery Back-up kit 60W 277-480V	BLD-GM60R-HV	-	14-1/2" x 3-1/16" x 1-7/8"	5	UL
Remote Control for Battery Back-up kit	RN1	-	5-1/8" x 1-1/4" x 5/8"	50	-
Spring Hook M10 for 100-240W	ASD-H-M10	Metallic	3-5/16" x 2-1/16" x 7/8"	50	UL
Spring Hook M10 for 300W	ASD-H-M12	Metallic	3-1/2" x 2-5/16" x 1"	50	UL
Screw-bolt Hook M10 for 100-240W	ASD-HS-M10	Black	3-7/8" x 1-5/8" x 1-5/16"	50	UL
Pendant Mount Bracket	ASD-PMB-UHB	Black	2-3/8" x 1-9/16" x 2-13/16"	50	-
Pendant Mount Bracket with J-box and Spring Hook	ASD-PMBJB-UHB	Black	4-3/4" x 5-1/16" x 7-3/16"	40	-
Surface Mount Bracket for 150-300W	ASD-SMB-UHB2A-BK	Black	10-5/8" x 10-5/8" x 8-1/4"	20	-
Surface Mount Bracket for 150-300W	ASD-SMB-UHB2A-WH	White	10-5/8" x 10-5/8" x 8-1/4"	20	-
Clear Lens 60" for 150-240W	ASD-L60C-UHB2A	Clear	8-11/16" x 8-11/16" x 7/16"	20	-
Clear Lens 60" for 300W	ASD-L60B-UHB2A	Clear	10-13/16" x 10-13/16" x 7/16"	20	-
Clear Lens 60" for 500W	ASD-L60E-UHB2A	Clear	13-15/16" x 13-15/16" x 5/16"	20	-

LED UFO HIGH BAY SLIM

ASD-UHS

Model	Watts	Input Voltage
-------	-------	---------------



NSF LED LINEAR HIGH BAY WITH Q-BASE

ASD-WFS-ST

Model	Size	Watts	Input Voltage	Dimmable	CCT	Lm	Dimensions LxWxH	Pcs. per Carton	Certification
ASD-WFS-ST-160	20"	100/130/160	120-277	0-10V	3,500/4,000/5,000	27,112	19-13/16" x 15-11/16" x 6-1/2"	1	NSF / UL / DLC PRM
ASD-WFS-ST-240	27"	180/210/240	120-277	0-10V	3,500/4,000/5,000	40,691	27-1/8" x 15-11/16" x 6-1/2"	1	NSF / UL / DLC PRM

ACCESSORIES

Infrared Motion Sensor 3pin 39ft White	ASD-09IR-WH	2-1/8" x 2-1/8" x 1-11/16"	120	UL
Infrared Motion Sensor 3pin 50ft White	ASD-09IR50-WH	2-1/8" x 2-1/8" x 1-11/16"	120	UL
Microwave Motion Sensor 3pin 49ft White	ASD-09MW-WH	2-1/8" x 2-1/8" x 1-5/16"	120	UL
Remote Control for Motion Sensor	ASD-06RC	5-11/16" x 1-3/4" x 13/16"	60	-

LED SEAMLESS VAPOR PROOF FIXTURE

ASD-LVP2SM

Model	Size	Watts	Input Voltage	Dimmable	CCT	Lm	Dimensions LxWxH	Pcs. per Carton	Certification
ASD-LVP2SM-2A28AC	2ft	16/24/28	120-277	0-10V	3,500/4,000/5,000	3,019	23-9/16" x 3-9/16" x 3-3/16"	9	UL / DLC STD
ASD-LVP2SM-4A56AC	4ft	32/48/56	120-277	0-10V	3,500/4,000/5,000	7,253	48-1/8" x 3-9/16" x 3-1/8"	9	UL / DLC STD
ASD-LVP2SM-8A120AC	8ft	64/96/120	120-277	0-10V	3,500/4,000/5,000	17,359	94-3/4" x 3-9/16" x 3-1/8"	6	UL / DLC STD

WITH BATTERY BACK-UP

ASD-LVP2SM-4A56AC-10EM	4ft	32/48/56	120-277	0-10V	3,500/4,000/5,000	7,140	48-1/8" x 3-9/16" x 3-1/8"	9	UL / DLC STD
ASD-LVP2SM-8A120AC-20EM	8ft	64/96/120	120-277	0-10V	3,500/4,000/5,000	17,325	94-3/4" x 3-9/16" x 3-1/8"	6	UL / DLC STD

WITH MOTION SENSOR

ASD-LVP2SM-4A56AC-MS	4ft	32/48/56	120-277	0-10V	3,500/4,000/5,000	6,330	47-3/16" x 3-9/16" x 3-3/16"	9	UL / DLC STD
Remote Control for Motion Sensor ASD-06RC							5-11/16" x 1-3/4" x 13/16"	60	-



LED STRIPLIGHT FIXTURE

ASD-LSF5

Model	Size	Watts	Input Voltage	Dimmable	CCT	Lm	Dimensions LxWxH	Pcs. per Carton	Certification
ASD-LSF5-2A28AC-PRM	2 ft	20/24/28	120-277	0-10V	3,500/4,000/5,000	3,890	26-3/16" x 2-5/8" x 2-11/16"	8	UL / DLC STD
ASD-LSF5-4A44AC-PRM	4 ft	22/28/36/44	120-277	0-10V	3,500/4,000/5,000	5,853	46-5/8" x 2-5/8" x 2-11/16"	8	UL / DLC STD
ASD-LSF5-8A90AC-PRM	8 ft	48/68/90	120-277	0-10V	3,500/4,000/5,000	12,523	92-13/16" x 2-5/8" x 2-11/16"	4	UL / DLC STD

WITH BATTERY BACK-UP

ASD-LSF5-2A28AC-EM-PRM	2 ft	20/24/28	120-277	0-10V	3,500/4,000/5,000	3,890	26-3/16" x 2-5/8" x 2-11/16"	8	UL / DLC STD
ASD-LSF5-4A44AC-12EM-PRM	4 ft	22/28/36/44	120-277	0-10V	3,500/4,000/5,000	5,853	46-5/8" x 2-5/8" x 2-11/16"	8	UL / DLC STD
ASD-LSF5-8A90AC-EM-PRM	8 ft	48/68/90	120-277	0-10V	3,500/4,000/5,000	12,523	92-13/16" x 2-5/8" x 2-11/16"	4	UL / DLC STD

STAIRWELL WITH MOTION SENSOR

ASD-LSF5-2A28AC-MS-SW	2 ft	20/24/28	120-277	0-10V	3,500/4,000/5,000	3,890	26-3/16" x 2-5/8" x 2-11/16"	8	UL / DLC STD
ASD-LSF5-4A44AC-MS-SW	4 ft	22/28/36/44	120-277	0-10V	3,500/4,000/5,000	5,853	46-5/8" x 2-5/8" x 2-11/16"	8	UL / DLC STD
ASD-LSF5-8A90AC-MS-PRM	8 ft	48/68/90	120-277	0-10V	3,500/4,000/5,000	12,523	92-13/16" x 2-5/8" x 2-11/16"	4	UL / DLC STD

Remote Control for Motion Sensor White

ASD-RC100LCD							5-13/16" x 2-3/4" x 1"	80	-
--------------	--	--	--	--	--	--	------------------------	----	---

STAIRWELL WITH MOTION SENSOR AND BATTERY BACK-UP

ASD-LSF5-4A44AC-12EM-MS-SW	4 ft	22/28/36/44	120-277	0-10V	3,500/4,000/5,000	5,853	46-5/8" x 2-5/8" x 2-11/16"	8	UL / DLC STD
Remote Control for Motion Sensor White ASD-RC100LCD							5-13/16" x 2-3/4" x 1"	80	-

ACCESSORIES

Connection bracket	ASD-CB-LSF5	5 1/4" x 2 3/4" x 11/16"	100	-
Wire Guard for 4 feet	ASD-WG4-LSF5	46-13/16" x 3-1/4" x 2-3/8"	8	-



LED STRIPLIGHT FIXTURE

ASD-LSF8

Model	Size	Watts	Input Voltage	Dimmable	CCT	Lm	Finish	Dimensions LxWxH	Pcs. per Carton	Certification
ASD-LSF8-2A25WH	2ft	15/20/25	120-277	0-10V	3,500/4,000/5,000	3,249	White	24" x 2-11/16" x 3-1/8"	9	UL / DLC PRM
ASD-LSF8-4A40WH	4ft	20/30/40	120-277	0-10V	3,500/4,000/5,000	5,866	White	47-1/4" x 2-11/16" x 3-1/8"	9	UL / DLC PRM
ASD-LSF8-4A40BK	4ft	20/30/40	120-277	0-10V	3,500/4,000/5,000	5,866	Black	47-1/4" x 2-11/16" x 3-1/8"	9	UL / DLC PRM
ASD-LSF8-8A80WH	8ft	55/75/80	120-277	0-10V	3,500/4,000/5,000	11,848	White	94-1/2" x 2-11/16" x 3-1/8"	6	UL / DLC STD
ASD-LSF8-8A80BK	8ft	55/75/80	120-277	0-10V	3,500/4,000/5,000	11,848	Black	94-1/2" x 2-11/16" x 3-1/8"	6	UL / DLC STD

HIGH VOLTAGE

ASD-LSF8HV-4A40WH	4ft	20/30/40	200-480	0-10V	3,500/4,000/5,000	6,030	White	47-1/4" x 2-11/16" x 3-1/8"	9	UL / DLC PRM
ASD-LSF8HV-8A80WH	8ft	55/75/80	200-480	0-10V	3,500/4,000/5,000	11,592	White	94-1/2" x 2-11/16" x 3-1/8"	6	UL / DLC PRM

WITH BATTERY BACK-UP

ASD-LSF8-2A25WH-8EM	2ft	15/20/25	120-277	0-10V	3,500/4,000/5,000	3,249	White	24" x 2-11/16" x 3-1/8"	9	UL / DLC PRM
ASD-LSF8-4A40WH-10EM	4ft	20/30/40	120-277	0-10V	3,500/4,000/5,000	5,866	White	47-1/4" x 2-11/16" x 3-1/8"	9	UL / DLC PRM
ASD-LSF8-4A40BK-10EM	4ft	20/30/40	120-277	0-10V	3,500/4,000/5,000	5,866	Black	47-1/4" x 2-11/16" x 3-1/8"	9	UL / DLC PRM
ASD-LSF8-8A80WH-15EM	8ft	55/75/80	120-277	0-10V	3,500/4,000/5,000	11,848	White	94-1/2" x 2-11/16" x 3-1/8"	6	UL / DLC STD
ASD-LSF8-8A80BK-15EM	8ft	55/75/80	120-277	0-10V	3,500/4,000/5,000	11,848	Black	94-1/2" x 2-11/16" x 3-1/8"	6	UL / DLC STD

ACCESSORIES

Connection bracket	ASD-CB-LSF8-BK	Black	2-3/16" x 2-3/16" x 1/16"	100	-
Connection bracket	ASD-CB-LSF8-WH	White	2-3/16" x 2-3/16" x 1/16"	100	-
Wire Guard for 4feet	ASD-WG4-LSF8	-	47-1/16" x 3-3/16" x 3-1/4"	10	-



LED STRIPLIGHT FIXTURE HIGH LUMENS

ASD-LSF8

Model	Size	Watts	Input Voltage	Dimmable	CCT	Lm	Finish	Dimensions LxWxH	Pcs. per Carton	Certification
ASD-LSF8-4A70WH	4ft	50/60/70	120-277	0-10V	3,500/4,000/5,000	9,124	White	47-1/4" x 2-11/16" x 3-3/16"	9	UL / DLC PRM
ASD-LSF8-8A150WH	8ft	100/130/150	120-277	0-10V	3,500/4,000/5,000	20,263	White	94-1/2" x 2-11/16" x 3-3/16"	6	UL / DLC STD

ACCESSORIES

Connection bracket	ASD-CB-LSF8-WH	White	2-3/16" x 2-3/16" x 1/16"	100	-
Wire Guard for 4feet	ASD-WG4-LSF8	-	47-1/16" x 3-3/16" x 3-1/4"	10	-



LED STRIPLIGHT FIXTURE WITH Q-BASE

ASD-LSF8-QB

Model	Size	Watts	Input Voltage	Dimmable	CCT	Lm	Finish	Dimensions LxWxH	Pcs. per Carton	Certification
ASD-LSF8-2A25WH-QB	2ft	15/20/25	120-277	0-10V	3,500/4,000/5,000	3,263	White	24" x 2-11/16" x 3-1/4"	9	UL / DLC PRM
ASD-LSF8-4A40WH-QB	4ft	20/30/40	120-277	0-10V	3,500/4,000/5,000	5,395	White	47-1/4" x 2-11/16" x 3-1/4"	9	UL / DLC PRM
ASD-LSF8-8A80WH-QB	8ft	55/75/80	120-277	0-10V	3,500/4,000/5,000	11,386	White	94-1/2" x 2-11/16" x 3-1/4"	6	UL / DLC STD

WITH BATTERY BACK-UP

ASD-LSF8-2A25WH-QB-8EM	2ft	15/20/25	120-277	0-10V	3,500/4,000/5,000	3,263	White	24" x 2-11/16" x 3-1/4"	9	UL / DLC PRM
ASD-LSF8-4A40WH-QB-10EM	4ft	20/30/40	120-277	0-10V	3,500/4,000/5,000	5,395	White	47-1/4" x 2-11/16" x 3-1/4"	9	UL / DLC PRM
ASD-LSF8-8A80WH-QB-15EM	8ft	55/75/80	120-277	0-10V	3,500/4,000/5,000	11,386	White	94-1/2" x 2-11/16" x 3-1/4"	6	UL / DLC STD

ACCESSORIES

Infrared Motion Sensor clip-in base 13ft	ASD-M22IR-WH	White	1-7/8" x 1-3/16" x 1-3/16"	200	UL
Remote Control for Motion Sensor	ASD-06RC	-	5-11/16" x 1-3/4" x 13/16"	60	-
Connection bracket	ASD-CB-LSF8-WH	White	2-3/16" x 2-3/16" x 1/16"	100	-
Wire Guard for 4feet	ASD-WG4-LSF8	-	47-1/16" x 3-3/16" x 3-1/4"	10	-



LED WRAP FIXTURE

ASD-WRL

Model	Size	Watts	Input Voltage	Dimmable	CCT	Lm	Dimensions LxWxH	Pcs. per Carton	Certification
ASD-WRL-4A48AC	4ft	32/40/48	120-277	0-10V	3,500/4,000/5,000	5,583	47-5/8" x 5-5/16" x 2-1/8"	4	UL / DLC STD

WITH BATTERY BACK-UP

ASD-WRL-4A48AC-8EM	4ft	32/40/48	120-277	0-10V	3,500/4,000/5,000	5,583	47-5/8" x 5-5/16" x 2-1/8"	4	UL / DLC STD
--------------------	-----	----------	---------	-------	-------------------	-------	----------------------------	---	--------------

LED WRAP FIXTURE

ASD-WRL2

Model	Size	Watts	Input Voltage	Dimmable	CCT	Lm	Dimensions LxWxH	Pcs. per Carton	Certification
ASD-WRL2-4A45AC	4ft	34/38/45	120-277	0-10V	3,500/4,000/5,000	6,312	46" x 9-3/4" x 3-7/16"	1	UL / DLC PRM

LED BACK-LIT PANEL

ASD-BLP

Model	Size	Watts	Input Voltage	Dimmable	CCT	Lm	Dimensions LxWxH	Pcs. per Carton	Certification
ASD-BLP-14A40-4P	1x4	25/30/40	120-277	0-10V	3,500/4,000/5,000	5,000	47-3/4" x 11-7/8" x 1-3/8"	1	UL / DLC PRM
ASD-BLP-22A30-4P	2x2	20/25/30	120-277	0-10V	3,500/4,000/5,000	3,633	23-3/4" x 23-3/4" x 1-3/8"	1	UL / DLC PRM
ASD-BLP-24A40-4P	2x4	25/30/40	120-277	0-10V	3,500/4,000/5,000	5,025	47-3/4" x 23-3/4" x 1-3/8"	1	UL / DLC PRM
ASD-BLP-24A50-4P	2x4	30/40/50	120-277	0-10V	3,500/4,000/5,000	6,341	47-3/4" x 23-3/4" x 1-3/8"	1	UL / DLC PRM

WITH MOTION SENSOR

ASD-BLP-22A30-MS-2P	2x2	20/25/30	120-277	0-10V	3,500/4,000/5,000	3,633	23-3/4" x 23-3/4" x 1-3/8"	2	UL / DLC PRM
ASD-BLP-24A40-MS-2P	2x4	25/30/40	120-277	0-10V	3,500/4,000/5,000	5,025	47-3/4" x 23-3/4" x 1-3/8"	2	UL / DLC PRM

WITH Q-BASE & BATTERY BACK-UP

ASD-BLP-22A30-QB-8EM-2P	2x2	20/25/30	120-277	0-10V	3,500/4,000/5,000	3,633	23-3/4" x 23-3/4" x 1-3/8"	2	UL / DLC PRM
ASD-BLP-24A40-QB-8EM-2P	2x4	25/30/40	120-277	0-10V	3,500/4,000/5,000	5,025	47-3/4" x 23-3/4" x 1-3/8"	2	UL / DLC PRM
Microwave Motion Sensor magnet base 16ft ASD-M2MW-WH							2-9/16" x 13/16" x 5/8"	120	UL
Remote Control for Motion Sensor ASD-06RC							5-11/16" x 1-3/4" x 13/16"	60	-

ACCESSORIES

Surface mounting Low Frame for 1x4	ASD-FELP14-L	48" x 12-1/8" x 1-15/16"	9	-
Surface mounting Low Frame for 2x2	ASD-FELP22-L	24" x 23-15/16" x 1-15/16"	9	-
Surface mounting Low Frame for 2x4	ASD-FELP24-L	48" x 23-15/16" x 1-15/16"	9	-

LED BACK-LIT PANEL HIGH LUMENS

ASD-BLP

Model	Size	Watts	Input Voltage	Dimmable	CCT	Lm	Dimensions LxWxH	Pcs. per Carton	Certification
ASD-BLP-24A67-4P	2x4	38/45/51/67	120-277	0-10V	3,000/3,500/4,000/5,000/6,500	10,050	47-3/4" x 23-3/4" x 1-3/8"	1	UL / DLC PRM

ACCESSORIES

Surface mounting Low Frame for 2x4	ASD-FELP24-L	48" x 23-15/16" x 1-15/16"	9	-
------------------------------------	--------------	----------------------------	---	---

LED BACK-LIT PANEL PRO series 10 YEAR WARRANTY

ASD-BLP-PRO

Model	Size	Watts	Input Voltage	Dimmable	CCT	Lm	Dimensions LxWxH	Pcs. per Carton	Certification
ASD-BLP-PRO-24A40-4P	2x4	25/30/40	120-277	0-10V	3,500/4,000/5,000	5,025	47-3/4" x 23-3/4" x 1-3/8"	1	UL / DLC PRM

ACCESSORIES

Surface mounting Low Frame for 2x4	ASD-FELP24-L	48" x 23-15/16" x 1-15/16"	9	-
------------------------------------	--------------	----------------------------	---	---

SMART LED BACK-LIT PANEL

ASD-BLP-SM

Model	Size	Watts	Input Voltage	Dimmable	CCT	Lm	Dimensions LxWxH	Pcs. per Carton	Certification
ASD-BLP-22035SM-2P	2x2	35	120-277	SMART APP	3,500-5,000	4,266	23-3/4" x 23-3/4" x 1-3/8"	2	UL / DLC PRM
ASD-BLP-24040SM-2P	2x4	40	120-277	SMART APP	3,500-5,000	4,924	47-3/4" x 23-3/4" x 1-3/8"	2	UL / DLC PRM

WITH RGBW

ASD-BLP-22035-RGBW-2P	2x2	35	120-277	SMART APP	3,500-5,000+RGBW	4,282	23-3/4" x 23-3/4" x 1-3/8"	2	UL
ASD-BLP-24040-RGBW-2P	2x4	40	120-277	SMART APP	3,500-5,000+RGBW	4,961	47-3/4" x 23-3/4" x 1-3/8"	2	UL

ACCESSORIES

Surface mounting Low Frame for 2x2	ASD-FELP22-L	24" x 23-15/16" x 1-15/16"	9	-
Surface mounting Low Frame for 2x4	ASD-FELP24-L	48" x 23-15/16" x 1-15/16"	9	-

LED TROFFER RETROFIT KIT

ASD-LTRK

Model	Size	Watts	Input Voltage	Dimmable	CCT	Lm	Dimensions LxWxH	Pcs. per Carton	Certification
ASD-LTRK-22A30-2P	2x2	20/25/30	120-277	0-10V	3,500/4,000/5,000	3,884	23-7/8" x 23-7/8" x 3-1/8"	1	UL / DLC STD
ASD-LTRK-24A45-2P	2x4	34/38/45	120-277	0-10V	3,500/4,000/5,000	6,380	47-13/16" x 23-7/8" x 3-1/8"	1	UL / DLC STD

LED TROFFER LIGHT

ASD-LTR

Model	Size	Watts	Input Voltage	Dimmable	CCT	Lm	Dimensions LxWxH	Pcs. per Carton	Certification
ASD-LTR-22A30-2P	2x2	20/25/30	120-277	0-10V	3,500/4,000/5,000	3,909	23-3/4" x 23-3/4" x 2-1/8"	1	UL / DLC STD
ASD-LTR-24A45-2P	2x4	34/38/45	120-277	0-10V	3,500/4,000/5,000	6,028	47-3/4" x 23-3/4" x 2-1/8"	1	UL / DLC STD

WITH BATTERY BACK-UP

ASD-LTR-22A30-EM-2P	2x2	20/25/30	120-277	0-10V	3,500/4,000/5,000	3,909	23-3/4" x 23-3/4" x 2-1/8"	1	UL / DLC STD
ASD-LTR-24A45-EM-2P	2x4	34/38/45	120-277	0-10V	3,500/4,000/5,000	6,028	47-3/4" x 23-3/4" x 2-1/8"	1	UL / DLC STD

LED TROFFER LIGHT HIGH LUMENS

ASD-LTR

Model	Size	Watts	Input Voltage	Dimmable	CCT	Lm	Dimensions LxWxH	Pcs. per Carton	Certification
ASD-LTR-24A70-2P	2x4	38/45/54/70	120-277	0-10V	3,000/3,500/4,000/5,000/6,500	9,174	47-3/4" x 23-3/4" x 2-1/8"	1	UL / DLC STD



LED ROUND TRIMLESS DOWNLIGHT

ASD-CD-TR

Model	Size	Watts	Input Voltage	Dimmable	CCT	Lm	Finish	Dimensions LxWxH	Pcs. per Carton	Certification
ASD-CD-TR-1D7AC-WH	1"	7	120	Triac	2,700/3,000/3,500/4,000/5,000	498	White	3-3/4" x 3-3/4" x 3-5/8"	24	ETL
ASD-CD-TR-2D8AC-WH	2"	8	120	Triac	2,700/3,000/3,500/4,000/5,000	643	White	3-9/16" x 3-9/16" x 2-3/8"	18	ETL / Energy Star
ASD-CD-TR-2D15AC-WH	2"	15	120	Triac	2,700/3,000/3,500/4,000/5,000	1,029	White	3-9/16" x 3-9/16" x 5-1/16"	18	ETL / Energy Star
ASD-CD-TR-2D15WH-4P	2"	15	120	Triac	2,700/3,000/3,500/4,000/5,000	1,029	White	3-9/16" x 3-9/16" x 5-1/16"	2	ETL
ASD-CD-TR-2D15AC-BK	2"	15	120	Triac	2,700/3,000/3,500/4,000/5,000	1,029	Black	3-9/16" x 3-9/16" x 5-1/16"	18	ETL / Energy Star
ASD-CD-TR-3D15AC-WH	3"	15	120	Triac	2,700/3,000/3,500/4,000/5,000	1,226	White	4-15/16" x 4-15/16" x 4-7/16"	18	ETL
ASD-CD-TR-3D12AC-WH	3.5"	12	120	Triac	2,700/3,000/3,500/4,000/5,000	933	White	5-7/8" x 5-7/8" x 2-15/16"	18	ETL
ASD-CD-TR-3D12WH-4P	3.5"	12	120	Triac	2,700/3,000/3,500/4,000/5,000	933	White	5-7/8" x 5-7/8" x 2-15/16"	2	ETL
ASD-CD-TR-3D12AC-BK	3.5"	12	120	Triac	2,700/3,000/3,500/4,000/5,000	933	Black	5-7/8" x 5-7/8" x 2-15/16"	18	ETL
ASD-CD-TR-4D15AC-WH	4"	15	120	Triac	2,700/3,000/3,500/4,000/5,000	1,055	White	5-7/8" x 5-7/8" x 3-1/8"	18	ETL / Energy Star
ASD-CD-TR-4D15WH-4P	4"	15	120	Triac	2,700/3,000/3,500/4,000/5,000	1,055	White	5-7/8" x 5-7/8" x 3-1/8"	2	ETL
ASD-CD-TR-4D15AC-BK	4"	15	120	Triac	2,700/3,000/3,500/4,000/5,000	1,055	Black	5-7/8" x 5-7/8" x 3-1/8"	18	ETL / Energy Star
ASD-CD-TR-6D24AC-WH	6"	24	120	Triac	2,700/3,000/3,500/4,000/5,000	2,075	White	8-11/16" x 8-11/16" x 3-9/16"	12	ETL
ASD-CD-TR-6D24AC-BK	6"	24	120	Triac	2,700/3,000/3,500/4,000/5,000	2,075	Black	8-11/16" x 8-11/16" x 3-9/16"	12	ETL

120-277V

ASD-CD-TR-MV-2D15AC-WH	2"	15	120-277	0-10V	2,700/3,000/3,500/4,000/5,000	1,077	White	3-9/16" x 3-9/16" x 4-15/16"	18	ETL
ASD-CD-TR-MV-4D15AC-WH	4"	15	120-277	0-10V	2,700/3,000/3,500/4,000/5,000	1,082	White	5-7/8" x 5-7/8" x 3-1/8"	18	ETL
ASD-CD-TR-MV-6D24AC-WH	6"	24	120-277	0-10V	2,700/3,000/3,500/4,000/5,000	2,023	White	8-11/16" x 8-11/16" x 3-5/8"	12	ETL

ACCESSORIES

Battery Back-up kit 8W	BLD-HM08D	10-7/16" x 1-15/16" x 15/16"	10	UL
Battery Back-up kit 15W	BLD-HM15D	12-15/16" x 1-7/16" x 15/16"	10	UL
Battery Back-up kit 15W	ASD-EMA15	14-5/8" x 1-5/8" x 1-7/16"	10	UL / DLC PRM



LED SQUARE TRIMLESS DOWNLIGHT

ASD-CD-TS

Model	Size	Watts	Input Voltage	Dimmable	CCT	Lm	Finish	Dimensions LxWxH	Pcs. per Carton	Certification
ASD-CD-TS-2D8AC-WH	2"	8	120	Triac	2,700/3,000/3,500/4,000/5,000	636	White	4-1/8" x 4-1/8" x 3-3/8"	18	ETL / Energy Star
ASD-CD-TS-2D15AC-WH	2"	15	120	Triac	2,700/3,000/3,500/4,000/5,000	1,026	White	4-1/8" x 4-1/8" x 5-9/16"	18	ETL / Energy Star
ASD-CD-TS-2D15AC-BK	2"	15	120	Triac	2,700/3,000/3,500/4,000/5,000	1,026	Black	4-1/8" x 4-1/8" x 5-9/16"	18	ETL / Energy Star
ASD-CD-TS-3D15AC-WH	3"	15	120	Triac	2,700/3,000/3,500/4,000/5,000	1,243	White	5-1/2" x 5-1/2" x 4-15/16"	18	ETL
ASD-CD-TS-3D12AC-WH	3.5"	12	120	Triac	2,700/3,000/3,500/4,000/5,000	953	White	5-11/16" x 5-11/16" x 3-1/16"	18	ETL
ASD-CD-TS-3D12AC-BK	3.5"	12	120	Triac	2,700/3,000/3,500/4,000/5,000	953	Black	5-11/16" x 5-11/16" x 3-1/16"	18	ETL
ASD-CD-TS-4D15AC-WH	4"	15	120	Triac	2,700/3,000/3,500/4,000/5,000	1,090	White	6-5/16" x 6-5/16" x 4"	18	ETL / Energy Star
ASD-CD-TS-4D15AC-BK	4"	15	120	Triac	2,700/3,000/3,500/4,000/5,000	1,090	Black	6-5/16" x 6-5/16" x 4"	18	ETL / Energy Star
ASD-CD-TS-6D24AC-WH	6"	24	120	Triac	2,700/3,000/3,500/4,000/5,000	2,038	White	8-1/8" x 8-1/8" x 3-11/16"	12	ETL
ASD-CD-TS-6D24AC-BK	6"	24	120	Triac	2,700/3,000/3,500/4,000/5,000	2,038	Black	8-1/8" x 8-1/8" x 3-11/16"	12	ETL

ACCESSORIES

Battery Back-up kit 8W	BLD-HM08D	10-7/16" x 1-15/16" x 15/16"	10	UL
Battery Back-up kit 15W	BLD-HM15D	12-15/16" x 1-7/16" x 15/16"	10	UL
Battery Back-up kit 15W	ASD-EMA15	14-5/8" x 1-5/8" x 1-7/16"	10	UL / DLC PRM



LED ROUND TRIMLESS DOWNLIGHT GIMBAL

ASD-CD-TG, ASD-CD-TGR

Model	Size	Watts	Input Voltage	Dimmable	CCT	Lm	Finish	Dimensions LxWxH	Pcs. per Carton	Certification
ASD-CD-TG-2D8AC-WH	2"	8	120	Triac	2,700/3,000/3,500/4,000/5,000	717	White	4-1/16" x 4-1/16" x 2-3/8"	18	ETL
ASD-CD-TGR-2D8AC-BK	2"	8	120	Triac	2,700/3,000/3,500/4,000/5,000	717	Black	4-1/16" x 4-1/16" x 2-11/16"	18	ETL
ASD-CD-TGR-3D12AC-WH	3"	12	120	Triac	2,700/3,000/3,500/4,000/5,000	1,043	White	4-1/16" x 4-1/16" x 5-9/16"	18	ETL
ASD-CD-TGR-4D17AC-WH	4"	17	120	Triac	2,700/3,000/3,500/4,000/5,000	1,623	White	6-11/16" x 6-11/16" x 4"	18	ETL

ACCESSORIES

Battery Back-up kit 8W	BLD-HM08D	10-7/16" x 1-15/16" x 15/16"	10	UL
Battery Back-up kit 15W	BLD-HM15D	12-15/16" x 1-7/16" x 15/16"	10	UL
Battery Back-up kit 15W	ASD-EMA15	14-5/8" x 1-5/8" x 1-7/16"	10	UL / DLC PRM



LED SQUARE TRIMLESS DOWNLIGHT GIMBAL

ASD-CD-TGS

Model	Size	Watts	Input Voltage	Dimmable	CCT	Lm	Finish	Dimensions LxWxH	Pcs. per Carton	Certification
ASD-CD-TGS-2D8AC-WH	2"	8	120	Triac	2,700/3,000/3,500/4,000/5,000	672	White	5-1/8" x 5-1/8" x 2-3/4"	18	ETL
ASD-CD-TGS-2D8AC-BK	2"	8	120	Triac	2,700/3,000/3,500/4,000/5,000	672	Black	5-1/8" x 5-1/8" x 2-3/4"	18	ETL

ACCESSORIES

Battery Back-up kit 8W	BLD-HM08D	10-7/16" x 1-15/16" x 15/16"	10	UL
Battery Back-up kit 15W	BLD-HM15D	12-15/16" x 1-7/16" x 15/16"	10	UL
Battery Back-up kit 15W	ASD-EMA15	14-5/8" x 1-5/8" x 1-7/16"	10	UL / DLC PRM

LED TRIMLESS COMBO DOWNLIGHT

ASD-TCS

Model	Head Quantity	Watts	Input Voltage	Dimmable	CCT	Lm	Finish	Dimensions LxWxH	Pcs. per Carton	Certification
ASD-TCS-1D15WH	1 pc	15	120	Triac	2,700/3,000/3,500/4,000/5,000	1,234	White	6-3/8" x 6-3/8" x 3-1/8"	18	ETL
ASD-TCS-2D30WH	2 pcs	30	120	Triac	2,700/3,000/3,500/4,000/5,000	2,112	White	10-1/8" x 6-3/8" x 3-1/8"	8	ETL
ASD-TCS-3D45WH	3 pcs	45	120	Triac	2,700/3,000/3,500/4,000/5,000	3,308	White	13-15/16" x 6-3/8" x 3-1/8"	4	ETL

LED ROUND DOWNLIGHT 1 & 2 INCH

ASD-CD-PR

Model	Size	Watts	Input Voltage	Dimmable	CCT	Lm	Finish	Dimensions DxD	Pcs. per Carton	Certification
ASD-CD-PR-1D7AC-BK	1"	7	120	Triac	2,700/3,000/3,500/4,000/5,000	550	Black	2-3/8" x 3-3/8"	24	ETL
ASD-CD-PR-1D7AC-WH	1"	7	120	Triac	2,700/3,000/3,500/4,000/5,000	550	White	2-3/8" x 3-3/8"	24	ETL
ASD-CD-PR-2D8AC-BK	2"	8	120	Triac	2,700/3,000/3,500/4,000/5,000	649	Black	3-1/8" x 2-3/4"	18	ETL
ASD-CD-PR-2D8AC-WH	2"	8	120	Triac	2,700/3,000/3,500/4,000/5,000	649	White	3-1/8" x 2-3/4"	18	ETL
ASD-CD-PR-2D15AC-BK	2"	15	120	Triac	2,700/3,000/3,500/4,000/5,000	1,110	Black	3-1/8" x 4-15/16"	18	ETL
ASD-CD-PR-2D15AC-WH	2"	15	120	Triac	2,700/3,000/3,500/4,000/5,000	1,110	White	3-1/8" x 4-15/16"	18	ETL

120-277V

ASD-CD-PR-MV-2D15AC-WH	2"	15	120-277	0-10V	2,700/3,000/3,500/4,000/5,000	1,087	White	3-1/8" x 4-15/16"	18	ETL
------------------------	----	----	---------	-------	-------------------------------	-------	-------	-------------------	----	-----

ACCESSORIES

Battery Back-up kit 8W	BLD-HM08D	10-7/16" x 1-15/16" x 15/16"	10	UL
Battery Back-up kit 15W	BLD-HM15D	12-15/16" x 1-7/16" x 15/16"	10	UL
Battery Back-up kit 15W	ASD-EMA15	14-5/8" x 1-5/8" x 1-7/16"	10	UL / DLC PRM



LED SQUARE DOWNLIGHT 1 & 2 INCH

ASD-CD-PS

Model	Size	Watts	Input Voltage	Dimmable	CCT	Lm	Finish	Dimensions LxWxH	Pcs. per Carton	Certification
ASD-CD-PS-1D7AC-BK	1"	7	120	Triac	2,700/3,000/3,500/4,000/5,000	560	Black	2-3/8" x 2-3/8" x 3-3/8"	24	ETL
ASD-CD-PS-1D7AC-WH	1"	7	120	Triac	2,700/3,000/3,500/4,000/5,000	560	White	2-3/8" x 2-3/8" x 3-3/8"	24	ETL
ASD-CD-PS-2D8AC-BK	2"	8	120	Triac	2,700/3,000/3,500/4,000/5,000	615	Black	3-1/8" x 3-1/8" x 2-13/16"	18	ETL
ASD-CD-PS-2D8AC-WH	2"	8	120	Triac	2,700/3,000/3,500/4,000/5,000	615	White	3-1/8" x 3-1/8" x 2-13/16"	18	ETL
ASD-CD-PS-2D15AC-BK	2"	15	120	Triac	2,700/3,000/3,500/4,000/5,000	1,103	Black	3-1/8" x 3-1/8" x 4-15/16"	18	ETL
ASD-CD-PS-2D15AC-WH	2"	15	120	Triac	2,700/3,000/3,500/4,000/5,000	1,103	White	3-1/8" x 3-1/8" x 4-15/16"	18	ETL

ACCESSORIES

Battery Back-up kit 8W	BLD-HM08D	10-7/16" x 1-15/16" x 15/16"	10	UL
Battery Back-up kit 15W	BLD-HM15D	12-15/16" x 1-7/16" x 15/16"	10	UL
Battery Back-up kit 15W	ASD-EMA15	14-5/8" x 1-5/8" x 1-7/16"	10	UL / DLC PRM



LED DOWNLIGHT 2 INCH WITH ROUND WASH TRIM

ASD-CD-PWR

Model	Size	Watts	Input Voltage	Dimmable	CCT	Lm	Finish	Dimensions DxD	Pcs. per Carton	Certification
ASD-CD-PWR-2D8AC-WH	2"	8	120	Triac	2,700/3,000/3,500/4,000/5,000	416	White	3-1/8" x 2-13/16"	18	ETL

ACCESSORIES

Battery Back-up kit 8W	BLD-HM08D	10-7/16" x 1-15/16
------------------------	-----------	--------------------



LED ROUND COMMERCIAL DOWNLIGHT

ASD-CDL7

Model	Size	Watts	Input Voltage	Dimmable	CCT	Lm	Finish	Dimensions DxH	Pcs. per Carton	Certification
ASD-CDL7-4DA13AC	4"	7/10/13	120-277	0-10 V	2,700/3,000/3,500/4,000/5,000	1,053	White	5-3/8" x 2-3/4"	8	UL / Energy Star
ASD-CDL7-6DA22AC	6"	12/14/16/18/22	120-277	0-10 V	2,700/3,000/3,500/4,000/5,000	1,726	White	8-1/4" x 3-7/16"	4	UL / ETL / Energy Star
ASD-CDL7-6DA22AC-BK	6"	10/15/22	120-277	0-10 V	2,700/3,000/3,500/4,000/5,000	1,850	Black	8-1/4" x 4"	8	UL / Energy Star
ASD-CDL7-8DA30AC	8"	14/18/22/26/30	120-277	0-10 V	2,700/3,000/3,500/4,000/5,000	2,507	White	10-1/16" x 3-7/16"	4	UL / ETL / Energy Star
ASD-CDL7-8DA30AC-BK	8"	12/20/30	120-277	0-10 V	2,700/3,000/3,500/4,000/5,000	2,400	Black	10-1/4" x 4-7/16"	8	UL / Energy Star
ASD-CDL7-10DA40AC	10"	20/25/30/35/40	120-277	0-10 V	2,700/3,000/3,500/4,000/5,000	3,445	White	11-7/16" x 4-5/16"	4	UL / Energy Star
ASD-CDL7-10DA40AC-BK	10"	20/30/40	120-277	0-10 V	2,700/3,000/3,500/4,000/5,000	3,000	Black	11-5/16" x 4-15/16"	4	UL / Energy Star

ACCESSORIES

Battery Back-up kit 8W	BLD-HM08D	10-7/16" x 1-15/16" x 15/16"	10	UL
Battery Back-up kit 15W	BLD-HM15D	12-15/16" x 1-7/16" x 15/16"	10	UL
Battery Back-up kit 15W	ASD-EMA15	14-5/8" x 1-5/8" x 1-7/16"	10	UL / DLC PRM
New Construction Flat Mounting Plate with Round Asymmetric holes 3-4-6"	ASD-MPLR-346-FA-6PACK	13-1/4" x 9-1/16" x 1/16"	4	-
New Construction Flat Mounting Plate with Round Asymmetric holes 3-4-6"	ASD-MPLR18-346-FA-6PACK	18" x 9-1/16" x 1/16"	4	-
New Construction Flat Mounting Plate with Round Asymmetric holes 8-10-12"	ASD-MPLR-81012-FA-6PACK	18-1/2" x 13-3/8" x 1/16"	4	-
New Construction Flat Mounting Plate with Round Symmetric holes 3-4-6"	ASD-MPLR-346-FS-6PACK	26" x 8-1/4" x 1/16"	4	-
New Construction Flat Mounting Plate with Round Symmetric holes 8-10-12"	ASD-MPLR-81012-FS-6PACK	26" x 13" x 1/16"	4	-
New Construction Mounting Plate with Round holes and Sliding Clips 3-4-6"	ASD-MPLR-346-SC-6PACK	14-3/8" x 10-9/16" x 1-5/8"	2	-
New Construction Mounting Plate with Round holes and Sliding Clips 8-10-12"	ASD-MPLR-81012-SC-6PACK	17-11/16" x 13" x 1-9/16"	2	-

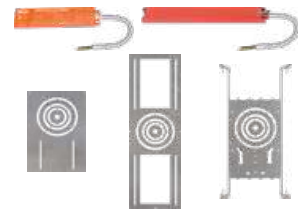

LED ROUND COMMERCIAL DOWNLIGHT

ASD-CDL7R

Model	Size	Watts	Input Voltage	Dimmable	CCT	Lm	Finish	Dimensions DxH	Pcs. per Carton	Certification
ASD-CDL7R-6A30-WH	6"	12/16/22/26/30	120-277	0-10 V	2,700/3,000/3,500/4,000/5,000	3,352	White	8-3/8" x 4-13/16"	8	ETL / Energy Star / T24 JA8
ASD-CDL7R-8A35WH	8"	16/22/26/30/35	120-277	0-10 V	2,700/3,000/3,500/4,000/5,000	4,245	White	10-5/16" x 5-5/16"	4	ETL / Energy Star
ASD-CDL7R-10A40WH	10"	22/26/30/35/40	120-277	0-10 V	2,700/3,000/3,500/4,000/5,000	4,791	White	11-9/16" x 5-15/16"	4	ETL / Energy Star

WITH BATTERY BACK-UP

ASD-CDL7R-6A30WH-EM	6"	12/16/22/26/30	120-277	0-10 V	2,700/3,000/3,500/4,000/5,000	3,352	White	8-11/16" x 4-5/16"	8	ETL
ASD-CDL7R-8A35WH-EM	8"	16/22/26/30/35	120-277	0-10 V	2,700/3,000/3,500/4,000/5,000	4,245	White	10-1/4" x 4-5/16"	4	ETL / Energy Star

ACCESSORIES

Battery Back-up kit 8W	BLD-HM08D	10-7/16" x 1-15/16" x 15/16"	10	UL
Battery Back-up kit 15W	BLD-HM15D	12-15/16" x 1-7/16" x 15/16"	10	UL
Battery Back-up kit 15W	ASD-EMA15	14-5/8" x 1-5/8" x 1-7/16"	10	UL / DLC PRM
New Construction Flat Mounting Plate with Round Asymmetric holes 3-4-6"	ASD-MPLR-346-FA-6PACK	13-1/4" x 9-1/16" x 1/16"	4	-
New Construction Flat Mounting Plate with Round Asymmetric holes 3-4-6"	ASD-MPLR18-346-FA-6PACK	18" x 9-1/16" x 1/16"	4	-
New Construction Flat Mounting Plate with Round Asymmetric holes 8-10-12"	ASD-MPLR-81012-FA-6PACK	18-1/2" x 13-3/8" x 1/16"	4	-
New Construction Flat Mounting Plate with Round Symmetric holes 3-4-6"	ASD-MPLR-346-FS-6PACK	26" x 8-1/4" x 1/16"	4	-
New Construction Flat Mounting Plate with Round Symmetric holes 8-10-12"	ASD-MPLR-81012-FS-6PACK	26" x 13" x 1/16"	4	-
New Construction Mounting Plate with Round holes and Sliding Clips 3-4-6"	ASD-MPLR-346-SC-6PACK	14-3/8" x 10-9/16" x 1-5/8"	2	-
New Construction Mounting Plate with Round holes and Sliding Clips 8-10-12"	ASD-MPLR-81012-SC-6PACK	17-11/16" x 13" x 1-9/16"	2	-



LED SQUARE COMMERCIAL DOWNLIGHT

ASD-CDL7S

Model	Size	Watts	Input Voltage	Dimmable	CCT	Lm	Finish	Dimensions LxWxH	Pcs. per Carton	Certification
ASD-CDL7S-6A30WH	6"	12/16/22/26/30	120-277	0-10 V	2,700/3,000/3,500/4,000/5,000	3,009	White	8-11/16" x 8-11/16" x 4-5/16"	8	ETL / Energy Star
ASD-CDL7S-8A35WH	8"	16/22/26/30/35	120-277	0-10 V	2,700/3,000/3,500/4,000/5,000	3,711	White	10-1/4" x 10-1/4" x 4-1/4"	4	ETL / Energy Star

ACCESSORIES

Battery Back-up kit 8W	BLD-HM08D	10-7/16" x 1-15/16" x 15/16"	10	UL
Battery Back-up kit 15W	BLD-HM15D	12-15/16" x 1-7/16" x 15/16"	10	UL
Battery Back-up kit 15W	ASD-EMA15	14-5/8" x 1-5/8" x 1-7/16"	10	UL / DLC PRM
New Construction Flat Mounting Plate with Square Asymmetric holes 3-4-6"	ASD-MPLS-346-FA-6PACK	13-1/4" x 9-1/16" x 1/16"	4	-
New Construction Flat Mounting Plate with Square Asymmetric holes 8-10-12"	ASD-MPLS-81012-FA-6PACK	18-1/2" x 13-3/8" x 1/16"	4	-
New Construction Flat Mounting Plate with Square Symmetric holes 3-4-6"	ASD-MPLS-346-FS-6PACK	26" x 8-1/4" x 1/16"	4	-
New Construction Flat Mounting Plate with Square Symmetric holes 8-10-12"	ASD-MPLS-81012-FS-6PACK	26" x 13" x 1/16"	4	-
New Construction Mounting Plate with Square holes and Sliding Clips 3-4-6"	ASD-MPLS-346-SC-6PACK	14-3/8" x 10-9/16" x 1-5/8"	2	-
New Construction Mounting Plate with Square holes and Sliding Clips 8-10-12"	ASD-MPLS-81012-SC-6PACK	17-11/16" x 13" x 1-9/16"	2	-



LED AREA LIGHT WITH Q-BASE NEOX series

ASD-LSB5B-NEOX

Model	Watts	Input Voltage	Dimmable	CCT	Lm	Finish	Dimensions LxWxH	Pcs. per Carton	Certification
ASD-LSB5B-NEOX-150BR	100/120/150	120-277	0-10V	3,000/4,000/5,000	27,933	Bronze	12-5/16" x 11-5/16" x 2-7/16"	1	UL / DLC PRM
ASD-LSB5B-NEOX-150BK	100/120/150	120-277	0-10V	3,000/4,000/5,000	27,933	Black	12-5/16" x 11-5/16" x 2-7/16"	1	UL / DLC PRM
ASD-LSB5B-NEOX-150SL	100/120/150	120-277	0-10V	3,000/4,000/5,000	27,933	Silver	12-5/16" x 11-5/16" x 2-7/16"	1	UL / DLC PRM
ASD-LSB5B-NEOX-150WH	100/120/150	120-277	0-10V	3,000/4,000/5,000	27,933	White	12-5/16" x 11-5/16" x 2-7/16"	1	UL / DLC PRM
ASD-LSB5B-NEOX-200BR	100/150/200	120-277	0-10V	3,000/4,000/5,000	36,837	Bronze	12-5/16" x 11-5/16" x 2-7/16"	1	UL / DLC PRM
ASD-LSB5B-NEOX-240BR	150/200/240	120-277	0-10V	3,000/4,000/5,000	44,202	Bronze	16-9/16" x 12-3/16" x 2-1/2"	1	UL / DLC PRM
ASD-LSB5B-NEOX-300BR	200/240/300	120-277	0-10V	3,000/4,000/5,000	56,362	Bronze	16-9/16" x 12-3/16" x 2-1/2"	1	UL / DLC PRM
ASD-LSB5B-NEOX-300BK	200/240/300	120-277	0-10V	3,000/4,000/5,000	56,362	Black	16-9/16" x 12-3/16" x 2-1/2"	1	UL / DLC PRM
ASD-LSB5B-NEOX-300SL	200/240/300	120-277	0-10V	3,000/4,000/5,000	56,362	Silver	16-9/16" x 12-3/16" x 2-1/2"	1	UL / DLC PRM
ASD-LSB5B-NEOX-300WH	200/240/300	120-277	0-10V	3,000/4,000/5,000	56,362	White	16-9/16" x 12-3/16" x 2-1/2"	1	UL / DLC PRM
ASD-LSB5B-NEOX-500BR	300/400/500	120-277	0-10V	3,000/4,000/5,000	91,874	Bronze	29-7/16" x 12-3/16" x 2-3/4"	1	UL / DLC PRM

HIGH VOLTAGE

ASD-LSB5BHV-NEOX-150BR	100/120/150	200-480	0-10V	3,000/4,000/5,000	27,901	Bronze	12-5/16" x 11-5/16" x 2-7/16"	1	UL / DLC PRM
ASD-LSB5BHV-NEOX-200BR	100/150/200	200-480	0-10V	3,000/4,000/5,000	37,446	Bronze	12-5/16" x 11-5/16" x 2-7/16"	1	UL / DLC PRM
ASD-LSB5BHV-NEOX-240BR	150/200/240	200-480	0-10V	3,000/4,000/5,000	44,132	Bronze	16-9/16" x 12-3/16" x 2-1/2"	1	UL / DLC PRM
ASD-LSB5BHV-NEOX-300BR	200/240/300	200-480	0-10V	3,000/4,000/5,000	56,080	Bronze	16-9/16" x 12-3/16" x 2-1/2"	1	UL / DLC PRM
ASD-LSB5BHV-NEOX-300WH	200/240/300	200-480	0-10V	3,000/4,000/5,000	56,080	White	16-9/16" x 12-3/16" x 2-1/2"	1	UL / DLC PRM
ASD-LSB5BHV-NEOX-500BR	300/400/500	200-480	0-10V	3,000/4,000/5,000	90,423	Bronze	29-7/16" x 12-3/16" x 2-3/4"	1	UL / DLC PRM

ACCESSORIES

Infrared Motion Sensor 3pin 39ft	ASD-091R-WH	White	2-1/8" x 2-1/8" x 1-11/16"	120	UL
Infrared Motion Sensor 3pin 39ft	ASD-091R-BK	Black	2-1/8" x 2-1/8" x 1-11/16"	120	UL
Infrared Motion Sensor 3pin 50ft	ASD-091R50-WH	White	2-1/8" x 2-1/8" x 1-11/16"	120	UL
Microwave Motion Sensor 3pin 49ft	ASD-09MW-WH	White	2-1/8" x 2-1/8" x 1-5/16"	120	UL
Microwave Motion Sensor 3pin 49ft	ASD-091R-BK	Black	2-1/8" x 2-1/8" x 1-5/16"	120	UL
Remote Control for Motion Sensor	ASD-06RC	-	5-11/16" x 1-3/4" x 13/16"	60	-
Arm Mounting Bracket for 100-300W	ASD-AM-LSB5-BR	Bronze	6-13/16" x 6-1/4" x 2-5/16"	10	-
Arm Mounting Bracket for 100-300W	ASD-AM-LSB5-BK	Black	6-13/16" x 6-1/4" x 2-5/16"	10	-
Arm Mounting Bracket for 100-300W	ASD-AM-LSB5-SL	Silver	6-13/16" x 6-1/4" x 2-5/16"	10	-
Arm Mounting Bracket for 100-300W	ASD-AM-LSB5-WH	White	6-13/16" x 6-1/4" x 2-5/16"	10	-
Adjustable Arm Mounting Bracket for 100-300W	ASD-AMR-LSB5-BR	Bronze	7-1/4" x 4-15/16" x 6-1/4"	20	-
Adjustable Arm Mounting Bracket for 100-300W	ASD-AMR-LSB5-BK	Black	7-1/4" x 4-15/16" x 6-1/4"	20	-
Adjustable Arm Mounting Bracket for 100-300W	ASD-AMR-LSB5-SL	Silver	7-1/4" x 4-15/16" x 6-1/4"	20	-
Adjustable Arm Mounting Bracket for 100-300W	ASD-AMR-LSB5-WH	White	7-1/4" x 4-15/16" x 6-1/4"	20	-
Adjustable Arm Mounting Bracket for 400-500W	ASD-AMR2-LSB-BR	Bronze	9-5/8" x 6-1/4" x 4-5/16"	10	-
Adjustable Arm Mounting Bracket for 400-500W	ASD-AMR2-LSB-BK	Black	9-5/8" x 6-1/4" x 4-5/16"	10	-
Adjustable Arm Mounting Bracket for 400-500W	ASD-AMR2-LSB-SL	Silver	9-5/8" x 6-1/4" x 4-5/16"	10	-
Adjustable Arm Mounting Bracket for 400-500W	ASD-AMR2-LSB-WH	White	9-5/8" x 6-1/4" x 4-5/16"	10	-
Floodlight Mounting Bracket for 100-200W	ASD-FM1-LSB5B-BR	Bronze	11-7/16" x 6-5/16" x 9-7/8"	10	-
Floodlight Mounting Bracket for 100-200W	ASD-FM1-LSB5B-BK	Black	11-7/16" x 6-5/16" x 9-7/8"	10	-
Floodlight Mounting Bracket for 100-200W	ASD-FM1-LSB5B-SL	Silver	11-7/16" x 6-5/16" x 9-7/8"	10	-
Floodlight Mounting Bracket for 100-200W	ASD-FM1-LSB5B-WH	White	11-7/16" x 6-5/16" x 9-7/8"	10	-
Floodlight Mounting Bracket for 240-300W	ASD-FM2-LSB5B-BR	Bronze	12-9/16" x 6-1/16" x 9-5/16"	10	-
Floodlight Mounting Bracket for 240-300W	ASD-FM2-LSB5B-BK	Black	12-9/16" x 6-1/16" x 9-5/16"	10	-
Floodlight Mounting Bracket for 240-300W	ASD-FM2-LSB5B-SL	Silver	12-9/16" x 6-1/16" x 9-5/16"	10	-
Floodlight Mounting Bracket for 240-300W	ASD-FM2-LSB5B-WH	White	12-9/16" x 6-1/16" x 9-5/16"	10	-
Floodlight Mounting Bracket for 400-500W	ASD-FM3-LSB5B-BR	Bronze	12-11/16" x 7-1/2" x 12-3/8"	5	-
Floodlight Mounting Bracket for 400-500W	ASD-FM3-LSB5B-BK	Black	12-11/16" x 7-1/2" x 12-3/8"	5	-
Floodlight Mounting Bracket for 400-500W	ASD-FM3-LSB5B-SL	Silver	12-11/16" x 7-1/2" x 12-3/8"	5	-
Floodlight Mounting Bracket for 400-500W	ASD-FM3-LSB5B-WH	White	12-11/16" x 7-1/2" x 12-3/8"	5	-
Slip fitter Mounting Bracket for 100-300W	ASD-SF-LSB5-BR	Bronze	7-1/16" x 4-15/16" x 3-1/16"	20	-
Slip					



LED AREA LIGHT PRO series

ASD-LSB5B-PRO

Model	Watts	Input Voltage	Dimmable	CCT	Lm	Finish	Dimensions LxWxH	Pcs. per Carton	Certification
ASD-LSB5B-PRO-150BR	100/120/150	120-277	0-10V	3,000/4,000/5,000	24,141	Bronze	12-5/16" x 11-5/16" x 2-7/16"	1	UL / DLC PRM
ASD-LSB5B-PRO-150BK	100/120/150	120-277	0-10V	3,000/4,000/5,000	24,141	Black	12-5/16" x 11-5/16" x 2-7/16"	1	UL / DLC PRM
ASD-LSB5B-PRO-150SL	100/120/150	120-277	0-10V	3,000/4,000/5,000	24,141	Silver	12-5/16" x 11-5/16" x 2-7/16"	1	UL / DLC PRM
ASD-LSB5B-PRO-150WH	100/120/150	120-277	0-10V	3,000/4,000/5,000	24,141	White	12-5/16" x 11-5/16" x 2-7/16"	1	UL / DLC PRM
ASD-LSB5B-PRO-200BR	100/150/200	120-277	0-10V	3,000/4,000/5,000	33,273	Bronze	12-5/16" x 11-5/16" x 2-7/16"	1	UL / DLC PRM
ASD-LSB5B-PRO-240BR	150/200/240	120-277	0-10V	3,000/4,000/5,000	39,419	Bronze	16-9/16" x 12-3/16" x 2-1/2"	1	UL / DLC PRM
ASD-LSB5B-PRO-300BR	200/240/300	120-277	0-10V	3,000/4,000/5,000	51,005	Bronze	16-9/16" x 12-3/16" x 2-1/2"	1	UL / DLC PRM
ASD-LSB5B-PRO-300BK	200/240/300	120-277	0-10V	3,000/4,000/5,000	51,005	Black	16-9/16" x 12-3/16" x 2-1/2"	1	UL / DLC PRM
ASD-LSB5B-PRO-300SL	200/240/300	120-277	0-10V	3,000/4,000/5,000	51,005	Silver	16-9/16" x 12-3/16" x 2-1/2"	1	UL / DLC PRM
ASD-LSB5B-PRO-300WH	200/240/300	120-277	0-10V	3,000/4,000/5,000	51,005	White	16-9/16" x 12-3/16" x 2-1/2"	1	UL / DLC PRM
ASD-LSB5B-PRO-500BR	300/400/500	120-277	0-10V	3,000/4,000/5,000	83,326	Bronze	29-7/16" x 12-3/16" x 2-3/4"	1	UL / DLC PRM
ASD-LSB5B-PRO-500SL	300/400/500	120-277	0-10V	3,000/4,000/5,000	83,326	Silver	29-7/16" x 12-3/16" x 2-3/4"	1	UL / DLC PRM

HIGH VOLTAGE

Model	Watts	Input Voltage	Dimmable	CCT	Lm	Finish	Dimensions LxWxH	Pcs. per Carton	Certification
ASD-LSB5BHV-PRO-150BR	100/120/150	200-480	0-10V	3,000/4,000/5,000	24,436	Bronze	12-5/16" x 11-5/16" x 2-7/16"	1	UL / DLC PRM
ASD-LSB5BHV-PRO-200BR	100/150/200	200-480	0-10V	3,000/4,000/5,000	34,052	Bronze	12-5/16" x 11-5/16" x 2-7/16"	1	UL / DLC PRM
ASD-LSB5BHV-PRO-240BR	150/200/240	200-480	0-10V	3,000/4,000/5,000	40,224	Bronze	16-9/16" x 12-3/16" x 2-1/2"	1	UL / DLC PRM
ASD-LSB5BHV-PRO-300BR	200/240/300	200-480	0-10V	3,000/4,000/5,000	51,208	Bronze	16-9/16" x 12-3/16" x 2-1/2"	1	UL / DLC PRM
ASD-LSB5BHV-PRO-300SL	200/240/300	200-480	0-10V	3,000/4,000/5,000	51,208	Silver	16-9/16" x 12-3/16" x 2-1/2"	1	UL / DLC PRM
ASD-LSB5BHV-PRO-500BR	300/400/500	200-480	0-10V	3,000/4,000/5,000	83,851	Bronze	29-7/16" x 12-3/16" x 2-3/4"	1	UL / DLC PRM
ASD-LSB5BHV-PRO-750BR	500/600/750	200-480	0-10V	3,000/4,000/5,000	130,822	Bronze	33-1/16" x 14-9/16" x 3-9/16"	1	UL / DLC PRM

ACCESSORIES

Infrared Motion Sensor 3pin 39ft	ASD-09IR-WH	White	2-1/8" x 2-1/8" x 1-11/16"	120	UL
Infrared Motion Sensor 3pin 39ft	ASD-09IR-BK	Black	2-1/8" x 2-1/8" x 1-11/16"	120	UL
Infrared Motion Sensor 3pin 50ft	ASD-09IR50-WH	White	2-1/8" x 2-1/8" x 1-11/16"	120	UL
Microwave Motion Sensor 3pin 49ft	ASD-09MW-WH	White	2-1/8" x 2-1/8" x 1-5/16"	120	UL
Microwave Motion Sensor 3pin 49ft	ASD-09IR-BK	Black	2-1/8" x 2-1/8" x 1-5/16"	120	UL
Remote Control for Motion Sensor	ASD-06RC	-	5-11/16" x 1-3/4" x 13/16"	60	-
Arm Mounting Bracket for 100-300W	ASD-AM-LSB5-BR	Bronze	6-13/16" x 6-1/4" x 2-5/16"	10	-
Arm Mounting Bracket for 100-300W	ASD-AM-LSB5-BK	Black	6-13/16" x 6-1/4" x 2-5/16"	10	-
Arm Mounting Bracket for 100-300W	ASD-AM-LSB5-SL	Silver	6-13/16" x 6-1/4" x 2-5/16"	10	-
Arm Mounting Bracket for 100-300W	ASD-AM-LSB5-WH	White	6-13/16" x 6-1/4" x 2-5/16"	10	-
Adjustable Arm Mounting Bracket for 100-300W	ASD-AMR-LSB5-BR	Bronze	7-1/4" x 4-15/16" x 6-1/4"	20	-
Adjustable Arm Mounting Bracket for 100-300W	ASD-AMR-LSB5-BK	Black	7-1/4" x 4-15/16" x 6-1/4"	20	-
Adjustable Arm Mounting Bracket for 100-300W	ASD-AMR-LSB5-SL	Silver	7-1/4" x 4-15/16" x 6-1/4"	20	-
Adjustable Arm Mounting Bracket for 100-300W	ASD-AMR-LSB5-WH	White	7-1/4" x 4-15/16" x 6-1/4"	20	-
Adjustable Arm Mounting Bracket for 400-500W	ASD-AMR2-LSB-BR	Bronze	9-5/8" x 6-1/4" x 4-5/16"	10	-
Adjustable Arm Mounting Bracket for 400-500W	ASD-AMR2-LSB-BK	Black	9-5/8" x 6-1/4" x 4-5/16"	10	-
Adjustable Arm Mounting Bracket for 400-500W	ASD-AMR2-LSB-SL	Silver	9-5/8" x 6-1/4" x 4-5/16"	10	-
Adjustable Arm Mounting Bracket for 400-500W	ASD-AMR2-LSB-WH	White	9-5/8" x 6-1/4" x 4-5/16"	10	-
Floodlight Mounting Bracket for 100-200W	ASD-FM1-LSB5B-BR	Bronze	11-7/16" x 6-5/16" x 9-7/8"	10	-
Floodlight Mounting Bracket for 100-200W	ASD-FM1-LSB5B-BK	Black	11-7/16" x 6-5/16" x 9-7/8"	10	-
Floodlight Mounting Bracket for 100-200W	ASD-FM1-LSB5B-SL	Silver	11-7/16" x 6-5/16" x 9-7/8"	10	-
Floodlight Mounting Bracket for 100-200W	ASD-FM1-LSB5B-WH	White	11-7/16" x 6-5/16" x 9-7/8"	10	-
Floodlight Mounting Bracket for 240-300W	ASD-FM2-LSB5B-BR	Bronze	12-9/16" x 6-1/16" x 9-5/16"	10	-
Floodlight Mounting Bracket for 240-300W	ASD-FM2-LSB5B-BK	Black	12-9/16" x 6-1/16" x 9-5/16"	10	-
Floodlight Mounting Bracket for 240-300W	ASD-FM2-LSB5B-SL	Silver	12-9/16" x 6-1/16" x 9-5/16"	10	-
Floodlight Mounting Bracket for 240-300W	ASD-FM2-LSB5B-WH	White	12-9/16" x 6-1/16" x 9-5/16"	10	-
Floodlight Mounting Bracket for 400-500W	ASD-FM3-LSB5B-BR	Bronze	12-11/16" x 7-1/2" x 12-3/8"	5	-
Floodlight Mounting Bracket for 400-500W	ASD-FM3-LSB5B-BK	Black	12-11/16" x 7-1/2" x 12-3/8"	5	-
Floodlight Mounting Bracket for 400-500W	ASD-FM3-LSB5B-SL	Silver	12-11/16" x 7-1/2" x 12-3/8"	5	-
Floodlight Mounting Bracket for 400-500W	ASD-FM3-LSB5B-WH	White	12-11/16" x 7-1/2" x 12-3/8"	5	-
Slip fitter Mounting Bracket for 100-300W	ASD-SF-LSB5-BR	Bronze	7-1/16" x 4-15/16" x 3-1/16"	20	-
Slip fitter Mounting Bracket for 100-300W	ASD-SF-LSB5-BK	Black	7-1/16" x 4-15/16" x 3-1/16"	20	-
Slip fitter Mounting Bracket for 100-300W	ASD-SF-LSB5-SL	Silver	7-1/16" x 4-15/16" x 3-1/16"	20	-
Slip fitter Mounting Bracket for 100-300W	ASD-SF-LSB5-WH	White	7-1/16" x 4-15/16" x 3-1/16"	20	-
Slip fitter Mounting Bracket for 400-500W	ASD-SF2-LSB-BR	Bronze	10-11/16" x 4-5/16" x 3-3/8"	10	-
Slip fitter Mounting Bracket for 400-500W	ASD-SF2-LSB-BK	Black	10-11/16" x 4-5/16" x 3-3/8"	10	-
Slip fitter Mounting Bracket for 400-500W	ASD-SF2-LSB-SL	Silver	10-11/16" x 4-5/16" x 3-3/8"	10	-
Slip fitter Mounting Bracket for 400-500W	ASD-SF2-LSB-WH	White	10-11/16" x 4-5/16" x 3-3/8"	10	-
Full Trunnion Mounting Bracket for 100-300W	ASD-TR-LSB5-BR	Bronze	6-9/16" x 4-7/16" x 1-7/8"	20	-
Full Trunnion Mounting Bracket for 100-300W	ASD-TR-LSB5-BK	Black	6-9/16" x 4-7/16" x 1-7/8"	20	-
Full Trunnion Mounting Bracket for 100-300W	ASD-TR-LSB5-SL	Silver	6-9/16" x 4-7/16" x 1-7/8"	20	-
Full Trunnion Mounting Bracket for 100-300W	ASD-TR-LSB5-WH	White	6-9/16" x 4-7/16" x 1-7/8"	20	-
Full Trunnion Mounting Bracket for 400-500W	ASD-TR2-LSB-BR	Bronze	7-1/16" x 5-7/8" x 2-11/16"	10	-
Full Trunnion Mounting Bracket for 400-500W	ASD-TR2-LSB-BK	Black	7-1/16" x 5-7/8" x 2-11/16"	10	-
Full Trunnion Mounting Bracket for 400-500W	ASD-TR2-LSB-SL	Silver	7-1/16" x 5-7/8" x 2-11/16"	10	-
Full Trunnion Mounting Bracket for 400-500W	ASD-TR2-LSB-WH	White	7-1/16" x 5-7/8" x 2-11/16"	10	-
Tenon Bracket	ASD-TN-BR	Bronze	9-7/16" x 3-15/16" x 8-11/16"	5	-
Dual Bull tenon Bracket for 100-300W	ASD-B2BT	Bronze	26" x 14-3/16" x 2-3/4"	2	-
Triple Bull tenon Bracket for 100-300W	ASD-B3BT	Bronze	37-13/16" x 14-3/16" x 2-3/4"	1	-
Wall Mounting Bracket for 100-300W	ASD-WMB-LSB-BR	Bronze	7-3/16" x 6-1/4" x 3-5/16"	8	-
Clear Lens Type II-S for 100-200W	ASD-L2A-LSB5B	Clear	10-9/16" x 5-7/8" x 1/2"	30	-
Clear Lens Type II-S for 240-500W	ASD-L2B-LSB5B	Clear	11-7/8" x 8-1/4" x 7/16"	30	-
Clear Lens Type IV-S for 100-200W	ASD-L4A-LSB5B	Clear	10-9/16" x 5-7/8" x 1/2"	30	-
Clear Lens Type IV-S for 240-500W	ASD-L4B-LSB5B	Clear	11-7/8" x 8-1/4" x 7/16"	30	-
Clear Lens Type V-S for 100-200W	ASD-L5A-LSB5B	Clear	10-9/16" x 5-7/8" x 1/2"	30	-
Clear Lens Type V-S for 240-500W	ASD-L5B-LSB5B	Clear	11-7/8" x 8-1/4" x 7/16"	30	-
60" Floodlight Clear Lens for 100-200W	ASD-LFLA-LSB5B	Clear	10-9/16" x 5-7/8" x 1/2"	30	-
60" Floodlight Clear Lens for 240-500W	ASD-LFLB-LSB5B	Clear	11-7/8" x 8-1/4" x 7/16"	30	-
Spill Shield for 100-200W	ASD-SPS-LSB5-BR	Bronze	11" x 5-7/8" x 2-3/4"	10	-
Spill Shield for 240-500W	ASD-SPS2-LSB5-BR	Bronze	11-15/16" x 8-1/2" x 2-3/4"	10	-
Back Cutoff Shield for 150-200W	ASD-BSA-LSB5B-BR	Bronze	10-9/16" x 5-7/8" x 2-3/4"	10	-
Back Cutoff Shield for 240-300W	ASD-BSB-LSB5B-BR	Bronze	11-1/2" x 8-9/16" x 2-3/4"	10	-



LED ROUND AREA LIGHT WITH Q-BASE

ASD-LSB5R-PRO

Model	Watts	Input Voltage	Dimmable	CCT	Lm	Finish	Dimensions LxWxH	Pcs. per Carton	Certification
ASD-LSB5R-PRO-100BR	35/55/75/100	120-277	0-10V	3,000/4,000/5,000	15,223	Bronze	11-1/2" x 11-7/16" x 2-5/8"	1	UL / DLC PRM
ASD-LSB5R-PRO-100BK	35/55/75/100	120-277	0-10V	3,000/4,000/5,000	15,223	Black	11-1/2" x 11-7/16" x 2-5/8"	1	UL / DLC PRM

WITH POST BRACKET

ASD-LSB5R-PRO-100BK-POST	35/55/75/100	120-277	0-10V	3,000/4,000/5,000	15,223	Black	11-1/2" x 12-9/16" x 18-3/4"	1	UL / DLC PRM
--------------------------	--------------	---------	-------	-------------------	--------	-------	------------------------------	---	--------------

ACCESSORIES

Infrared Motion Sensor 3pin 39ft	ASD-09IR-WH	White	2-1/8" x 2-1/8" x 1-11/16"	120	UL
Infrared Motion Sensor 3pin 39ft	ASD-09IR-BK	Black	2-1/8" x 2-1/8" x 1-11/16"	120	UL
Infrared Motion Sensor 3pin 50ft	ASD-09IR50-WH	White	2-1/8" x 2-1/8" x 1-11/16"	120	UL
Microwave Motion Sensor 3pin 49ft	ASD-09MW-WH	White	2-1/8" x 2-1/8" x 1-5/16"	120	UL
Microwave Motion Sensor 3pin 49ft	ASD-09IR-BK	Black	2-1/8" x 2-1/8" x 1-5/16"	120	UL
Remote Control for Motion Sensor	ASD-06RC	-	5-11/16" x 1-3/4" x 13/16"	60	-
Post Bracket	ASD-POST-LSB5-BR	Bronze	8-3/4" x 18-1/4" x 4-8/15/16"	4	-
Post Bracket	ASD-POST-LSB5	Black	8-3/4" x 18-1/4" x 4-8/15/16"	4	-
Arm Mounting Bracket for 100-300W	ASD-AM-LSB5-BR	Bronze	6-13/16" x 6-1/4" x 2-5/16"	10	-
Arm Mounting Bracket for 100-300W	ASD-AM-LSB5-BK	Black	6-13/16" x 6-1/4" x 2-5/16"	10	-
Adjustable Arm Mounting Bracket for 100-300W	ASD-AMR-LSB5-BR	Bronze	7-1/4" x 4-15/16" x 6-1/4"	20	-
Adjustable Arm Mounting Bracket for 100-300W	ASD-AMR-LSB5-BK	Black	7-1/4" x 4-15/16" x 6-1/4"	20	-
Slip fitter Mounting Bracket for 100-300W	ASD-SF-LSB5-BR	Bronze	7-1/16" x 4-15/16" x 3-1/16"	20	-
Slip fitter Mounting Bracket for 100-300W	ASD-SF-LSB5-BK	Black	7-1/16" x 4-15/16" x 3-1/16"	20	-
Full Trunnion Mounting Bracket for 100-300W	ASD-TR-LSB5-BR	Bronze	6-9/16" x 4-7/16" x 1-7/8"	20	-
Full Trunnion Mounting Bracket for 100-300W	ASD-TR-LSB5-BK	Black	6-9/16" x 4-7/16" x 1-7/8"	20	-

LED SPORT LIGHT

ASD-SPFL7, ASD-SPFL7-DMX

Model	Watts	Input Voltage	Dimmable	CCT	Lm	Beam angles	Dimensions LxWxH	Pcs. per Carton	Certification
ASD-SPFL7-300D50	300	120-277	0-10V	5,000	44,914	45°	17-5/8" x 16-1/8" x 16-1/16"	1	UL / DLC PRM
ASD-SPFL7-A500D50	300/400/500	120-277	0-10V	5,000	75,057				



LED SLIM CANOPY

ASD-CAN05

Model	Watts	Input Voltage	Dimmable	CCT	Lm	Finish	Dimensions LxWxH	Pcs. per Carton	Certification
ASD-CAN05-A40BR	20/30/40	120-277	0-10V	3,000/4,000/5,000	6,061	Bronze	10-1/6" x 10-1/6" x 3-5/16"	4	UL / DLC PRM
ASD-CAN05-A70BR	40/60/70	120-277	0-10V	3,000/4,000/5,000	10,795	Bronze	10-1/6" x 10-1/6" x 3-5/16"	4	UL / DLC PRM



LED LOW-PROFILE CANOPY WITH Q-BASE

ASD-CAN07A

Model	Watts	Input Voltage	Dimmable	CCT	Lm	Finish	Dimensions LxWxH	Pcs. per Carton	Certification
ASD-CAN07A-45WH	45	120-277	1-10V	3,000/4,000/5,000	6,917	White	10-9/16" x 9-13/16" x 2-15/16"	6	UL / DLC PRM
ASD-CAN07A-45BK	45	120-277	1-10V	3,000/4,000/5,000	6,917	Black	10-9/16" x 9-13/16" x 2-15/16"	6	UL / DLC PRM
ASD-CAN07A-70WH	70	120-277	1-10V	3,000/4,000/5,000	9,332	White	10-9/16" x 9-13/16" x 2-15/16"	6	UL / DLC PRM
ASD-CAN07A-70BK	70	120-277	1-10V	3,000/4,000/5,000	9,332	Black	10-9/16" x 9-13/16" x 2-15/16"	6	UL / DLC PRM

WITH BATTERY BACK-UP

ASD-CAN07A-45WH-8EM	45	120-277	0-10V	3,000/4,000/5,000	6,917	White	10-9/16" x 9-13/16" x 2-15/16"	6	UL / DLC PRM
ASD-CAN07A-45BK-8EM	45	120-277	0-10V	3,000/4,000/5,000	6,917	Black	10-9/16" x 9-13/16" x 2-15/16"	6	UL / DLC PRM

ACCESSORIES

Infrared Motion Sensor 3pin 39ft				ASD-09IR-WH	White	2-1/8" x 2-1/8" x 1-11/16"	120	UL
Infrared Motion Sensor 3pin 39ft				ASD-09IR-BK	Black	2-1/8" x 2-1/8" x 1-11/16"	120	UL
Infrared Motion Sensor 3pin 50ft				ASD-09IR50-WH	White	2-1/8" x 2-1/8" x 1-11/16"	120	UL
Microwave Motion Sensor 3pin 49ft				ASD-09MW-WH	White	2-1/8" x 2-1/8" x 1-5/16"	120	UL
Microwave Motion Sensor 3pin 49ft				ASD-09IR-BK	Black	2-1/8" x 2-1/8" x 1-5/16"	120	UL
Remote Control for Motion Sensor				ASD-06RC	-	5-11/16" x 1-3/4" x 13/16"	60	-



LED SQUARE EDGE-LIT CANOPY WITH Q-BASE

ASD-CAN09S

Model	Watts	Input Voltage	Dimmable	CCT	Lm	Finish	Dimensions LxWxH	Pcs. per Carton	Certification
ASD-CAN09S-A50WH	30/40/50	120-277	0-10V	3,000/4,000/5,000	6,887	White	10" x 10" x 3-1/16"	4	UL / DLC PRM
ASD-CAN09S-A50BK	30/40/50	120-277	0-10V	3,000/4,000/5,000	6,887	Black	10" x 10" x 3-1/16"	4	UL / DLC PRM
ASD-CAN09S-A80WH	50/70/80	120-277	0-10V	3,000/4,000/5,000	11,033	White	10" x 10" x 3-1/16"	4	UL / DLC PRM
ASD-CAN09S-A80BK	50/70/80	120-277	0-10V	3,000/4,000/5,000	11,033	Black	10" x 10" x 3-1/16"	4	UL / DLC PRM
ASD-CAN09S-A100WH	60/70/100	120-277	0-10V	3,000/4,000/5,000	14,363	White	10-1/16" x 10-1/16" x 2-3/4"	4	UL / DLC PRM
ASD-CAN09S-A100BK	60/70/100	120-277	0-10V	3,000/4,000/5,000	14,363	Black	10-1/16" x 10-1/16" x 2-3/4"	4	UL / DLC PRM

WITH BATTERY BACK-UP

ASD-CAN09S-A80WH-8EM	50/70/80	120-277	0-10V	3,000/4,000/5,000	11,033	White	10" x 10" x 3-1/16"	4	UL / DLC PRM
ASD-CAN09S-A80BK-8EM	50/70/80	120-277	0-10V	3,000/4,000/5,000	11,033	Black	10" x 10" x 3-1/16"	4	UL / DLC PRM

ACCESSORIES

Infrared Motion Sensor 3pin 39ft				ASD-09IR-WH	White	2-1/8" x 2-1/8" x 1-11/16"	120	UL
Infrared Motion Sensor 3pin 39ft				ASD-09IR-BK	Black	2-1/8" x 2-1/8" x 1-11/16"	120	UL
Infrared Motion Sensor 3pin 50ft				ASD-09IR50-WH	White	2-1/8" x 2-1/8" x 1-11/16"	120	UL
Microwave Motion Sensor 3pin 49ft				ASD-09MW-WH	White	2-1/8" x 2-1/8" x 1-5/16"	120	UL
Microwave Motion Sensor 3pin 49ft				ASD-09IR-BK	Black	2-1/8" x 2-1/8" x 1-5/16"	120	UL
Remote Control for Motion Sensor				ASD-06RC	-	5-11/16" x 1-3/4" x 13/16"	60	-



LED SECURITY WALLPACK

ASD-SWP

Model	Watts	Input Voltage	Dimmable	CCT	Lm	Dimensions LxWxH	Pcs. per Carton	Certification
ASD-SWP-28BR-PC	28	120	No	3,000/4,000/5,000	3,403	8-3/8" x 5-11/16" x 2-11/16"	6	UL
ASD-SWP-MV-A28BR-PC	20/24/28	120-277	0-10V	3,000/4,000/5,000	3,454	8-3/8" x 5-11/16" x 2-11/16"	6	UL / DLC PRM

WITH BATTERY BACK-UP

ASD-SWP-MV-A28BR-PC-5EM	20/24/28	120-277	0-10V	3,000/4,000/5,000	3,454	8-3/8" x 5-11/16" x 2-11/16"	6	UL / DLC PRM
-------------------------	----------	---------	-------	-------------------	-------	------------------------------	---	--------------



LED TRADITIONAL WALLPACK

ASD-WLP01

Model	Watts	Input Voltage	Dimmable	CCT	Lm	Dimensions LxWxH	Pcs. per Carton	Certification
ASD-WLP01-50D50-PC	50	120-277 V	0-10V	5,000	7,692	14" x 9" x 7-1/8"	1	UL / DLC PRM
ASD-WLP01-50A-PC	30/40/50	120-277 V	0-10V	3,000/4,000/5,000	7,889	14" x 9" x 7-1/8"	1	UL / DLC PRM
ASD-WLP01-80D50-PC	80	120-277 V	0-10V	5,000	11,973	14" x 9" x 7-1/8"	1	UL / DLC PRM
ASD-WLP01-80A-PC	50/60/80	120-277 V	0-10V	3,000/4,000/5,000	12,213	14" x 9" x 7-1/8"	1	UL / DLC PRM
ASD-WLP01-120A-PC	80/100/120	120-277 V	1-10V	3,000/4,000/5,000	17,571	14" x 9" x 7-1/8"	1	UL / DLC PRM
ASD-WLP01-150A-PC	100/120/150	120-277 V	0-10V	3,000/4,000/5,000	21,262	17-1/2" x 9-13/16" x 8-1/16"	1	UL / DLC PRM

WITH BATTERY BACK-UP

ASD-WLP01-50A-PC-8EM	30/40/50	120-277 V	0-10 V	3,000/4,000/5,000	7,889	14" x 9" x 7-3/16"	1	UL / DLC PRM
ASD-WLP01-80A-PC-15EM	50/60/80	120-277 V	0-10 V	3,000/4,000/5,000	12,213	14" x 9" x 7-3/16"	1	UL / DLC PRM
ASD-WLP01-120A-PC-25EM	80/100/120	120-277 V	0-10V	3,000/4,000/5,000	17,571	14" x 9" x 7-3/16"	1	UL / DLC PRM



LED ADJUSTABLE CUTOFF WALLPACK

ASD-WLP02A

Model	Watts	Input Voltage	Dimmable	CCT	Lm	Dimensions LxWxH	Pcs. per Carton	Certification
ASD-WLP02A-12DAC-PC-BK	12	120-277 V	0-10 V	3,000/4,000/5,000	1,686	5-7/8" x 5-1/16" x 3-9/16"	12	UL / DLC PRM
ASD-WLP02A-30DAC-PC-BK	30	120-277 V	0-10 V	3,000/4,000/5,000	4,058	9-1/8" x 7-5/8" x 4-5/8"	6	UL / DLC PRM
ASD-WLP02A-50DAC-PC-BK	50	120-277 V	0-10 V	3,000/4,000/5,000	7,047	9-1/8" x 7-5/8" x 4-5/8"	6	UL / DLC PRM

LED FULL CUTOFF WALLPACK

ASD-WLP03

Model	Watts	Input Voltage	Dimmable	CCT	Lm	Dimensions LxWxH	Pcs. per Carton	Certification
ASD-WLP03-A50DAC-BR	30/40/50	120-277 V	0-10 V	3,000/4,000/5,000	6,723	14-3/16" x 9-1/4" x 6-9/16"	4	UL / DLC PRM
ASD-WLP03-A80DAC-BR	50/60/80	120-277 V	0-10 V	3,000/4,000/5,000	10,208	14-3/16" x 9-1/4" x 6-9/16"	4	UL / DLC PRM
ASD-WLP03-A120DAC-BR	80/100/120	120-277 V	0-10 V	3,000/4,000/5,000	16,198	14-3/16" x 9-1/4" x 6-9/16"	4	UL / DLC PRM

ACCESSORIES

Photocell kit				ASD-PC-WLP		7/8" x 7/8" x 3/4"	100	
---------------	--	--	--	------------	--	--------------------	-----	--



LED SLIM WALLPACK

ASD-WLS

Model	Watts	Input Voltage	Dimmable	CCT	Lm	Dimensions LxWxH	Pcs. per Carton	Certification
ASD-WLS-A50BR-PC	30/40/50	120-277 V	0-10 V	3,000/4,000/5,000	6,577	11-3/4" x 8-3/4" x 4-1/8"	1	UL / DLC PRM
ASD-WLS-A60BR-PC	40/50/60	120-277 V	0-10 V	3,000/4,000/5,000	7,706	14" x 9-3/16" x 4-5/16"	1	UL / DLC PRM
ASD-WLS-A80BR-PC	60/70/80	120-277 V	0-10 V	3,000/4,000/5,000	10,239	14" x 9-3/16" x 4-5/16"	1	UL / DLC PRM
ASD-WLS-A120BR-PC	80/100/120	120-277 V	0-10 V	3,000/4,000/5,000	14,376	14" x 9-3/16" x 4-5/16"	1	UL / DLC PRM

LED ROUND WALLPACK

ASD-WLR, ASD-WLR-UD

Model	Light Direction	Watts	Input Voltage	Dimmable	CCT	Lm	Dimensions LxWxH	Pcs. per Carton	Certification
ASD-WLR-60BR-PC	1	40/50/60	120-277 V	0-10 V	3,000/4,000/5,000	8,538	10-1/2" x 6-3/4" x 4-1/2"	1	UL / DLC PRM
ASD-WLR-120BR-PC	1	80/100/120	120-277 V	0-10 V	3,000/4,000/5,000	16,716	14" x 8-3/4" x 6-1/16"	1	UL / DLC PRM
ASD-WLR-60BR-PC-UD	2	40/50/60	120-277 V	0-10 V	3,000/4,000/5,000	8,696	10-1/2" x 5-5/8" x 4-1/2"	1	UL / DLC PRM
ASD-WLR-120BR-PC-UD	2	80/100/120	120-277 V	0-10 V	3,000/4,000/5,000	17,000	14" x 7-5/8" x 6-1/16"	1	UL / DLC PRM





VAPOR JELLY JAR RGBCW LIGHT

ASD-VTJ

Model	Size	Watts	Input Voltage	Dimmable	CCT	Lm	Finish	Dimensions LxWxH	Pcs. per Carton	Certification
ASD-VTJ-20RGBCW	15"	12/16/20	120-277	0-10V	3,000/5,000/RGB	2,148	Gray	4-15/16" x 4-15/16" x 15-1/16"	6	UL



LED DUAL-HEAD SECURITY LIGHTS

ASD-SFL

Model	Watts	Input Voltage	Dimmable	CCT	Lm	Finish	Dimensions LxWxH	Pcs. per Carton	Certification
ASD-SFL2-20WH	20	120	No	2,700/3,000/3,500/4,000/5,000	2,156	White	10-1/4" x 4-15/16" x 4-7/16"	8	UL / DLC PRM
ASD-SFL2-20BK	20	120	No	2,700/3,000/3,500/4,000/5,000	2,045	Black	10-1/4" x 4-15/16" x 4-7/16"	8	UL / DLC PRM

WITH MOTION SENSOR & PHOTOCELL

ASD-SFL-20WH	20	120	No	2,700/3,000/3,500/4,000/5,000	2,204	White	10-1/4" x 4-7/16" x 6-13/16"	8	UL / DLC PRM
ASD-SFL-20BK	20	120	No	2,700/3,000/3,500/4,000/5,000	2,045	Black	10-1/4" x 4-7/16" x 6-13/16"	8	UL / DLC PRM

WITH CAMERA

ASD-SFL-20WH-SC	20	120	No	2,700/3,000/3,500/4,000/5,000	2,017	White	10-1/4" x 4-7/16" x 7-11/16"	6	UL / DLC PRM
ASD-SFL-20BK-SC	20	120	No	2,700/3,000/3,500/4,000/5,000	2,017	Black	10-1/4" x 4-7/16" x 7-11/16"	6	UL / DLC PRM



Q-BASE MOTION SENSOR

Model	Type	Base	Input Voltage	Dimmable	IP	Installation Height	Finish	Dimensions LxWxH	Pcs. per Carton	Certification
ASD-M2MW-WH	Microwave	Magnet	12V	0-10 V	IP20	16ft	White	2-9/16" x 13/16" x 5/8"	120	UL
ASD-08MW-WH	Microwave	Audio-jack	12V	0-10 V	IP20	12ft	White	2-5/8" x 3/4" x 1"	120	UL
ASD-09IR-WH	Infrared	3pin	12V	0-10 V	IP65	39ft	White	2-1/8" x 2-1/8" x 1-11/16"	120	UL
ASD-09IR-BK	Infrared	3pin	12V	0-10 V	IP65	39ft	Black	2-1/8" x 2-1/8" x 1-11/16"	120	UL
ASD-09IR50-WH	Infrared	3pin	12V	0-10 V	IP65	50ft	White	2-1/8" x 2-1/8" x 1-11/16"	120	UL
ASD-09MW-WH	Microwave	3pin	12V	0-10 V	IP65	49ft	White	2-1/8" x 2-1/8" x 1-5/16"	120	UL
ASD-09MW-BK	Microwave	3pin	12V	0-10 V	IP65	49ft	Black	2-1/8" x 2-1/8" x 1-5/16"	120	UL
ASD-S10IR-WH	Infrared	3pin	10-15V	0-10 V	IP65	39ft	White	3-3/4" x 2-3/8" x 2-1/2"	120	UL
ASD-M22IR-WH	Infrared	Clip-in	12V	0-10 V	IP20	13ft	White	1-7/8" x 1-3/16" x 1-3/16"	200	UL

ACCESSORIES

Remote Control for Motion Sensor	ASD-06RC	-	5-11/16" x 1-3/4" x 13/16"	60	-
----------------------------------	----------	---	----------------------------	----	---

EMERGENCY BATTERY BACK-UP

Model	Watts	Input Voltage	IP	Dimensions LxWxH	Pcs. per Carton	Certification
BLD-HM08D	8	120-277 V	IP20	10-7/16" x 1-15/16" x 15/16"	10	UL
BLD-HM15D	15	120-277 V	IP40	12-15/16" x 1-7/16" x 15/16"	10	UL
ASD-EMA15	15	120-277 V	IP20	14-5/8" x 1-5/8" x 1-7/16"	10	UL / DLC PRM
ASD-EMK20W-WHB5B	20	120-277 V	IP40	9-5/8" x 4-5/8" x 1-7/8"	10	-
ASD-EMK30W-WHB5A	30	120-277 V	IP40	9-5/8" x 4-5/8" x 1-7/8"	10	-
BLD-RM40R	40	120-277 V	IP65	15-11/16" x 15-11/16" x 5-9/16"	4	UL
ASD-EMB40	40	120-277 V	IP65	8-3/8" x 5-3/16" x 4-13/16"	6	UL / DLC PRM
BLD-RM60R	60	120-277 V	IP65	15-11/16" x 5-3/4" x 5-3/4"	4	UL
ASD-EMB60	60	120-277 V	IP65	8-3/8" x 5-3/16" x 4-13/16"	6	UL / DLC PRM
BLD-GM60R-HV	60	277-480 V	IP65	14-1/2" x 3-1/16" x 1-7/8"	5	UL
Remote Test Switch for Battery Back-up RNI				5-11/16" x 1-3/4" x 13/16"	60	-



LED FLUSHMOUNT LOFT

ASD-LOFT-FM, ASD-LOFT-FM-RGBW

Model	Size	Watts	Input Voltage	Dimmable	CCT	Lm	Finish	Dimensions DxH	Pcs. per Carton	Certification
ASD-LOFT-FM-12D20BK	12"	20	120	Triac	2,700/3,000/3,500/4,000/5,000	1,130	Black	11-13/16" x 3-1/2"	4	ETL
ASD-LOFT-FM-12D20NK	12"	20	120	Triac	2,700/3,000/3,500/4,000/5,000	1,130	Nickel	11-13/16" x 3-1/2"	4	ETL
ASD-LOFT-FM-14D24BK	14"	24	120	Triac	2,700/3,000/3,500/4,000/5,000	1,534	Black	14" x 3-3/4"	4	ETL
ASD-LOFT-FM-14D24NK	14"	24	120	Triac	2,700/3,000/3,500/4,000/5,000	1,534	Nickel	14" x 3-3/4"	4	ETL
ASD-LOFT-FM-16D28BK	16"	28	120	Triac	2,700/3,000/3,500/4,000/5,000	1,752	Black	15-5/16" x 3-11/16"	4	ETL
ASD-LOFT-FM-16D28NK	16"	28	120	Triac	2,700/3,000/3,500/4,000/5,000	1,752	Nickel	15-5/16" x 3-11/16"	4	ETL
ASD-LOFT-FM-18D35BK	18"	35	120	Triac	2,700/3,000/3,500/4,000/5,000	1,992	Black	17-15/16" x 3-15/16"	2	ETL
ASD-LOFT-FM-18D35NK	18"	35	120	Triac	2,700/3,000/3,500/4,000/5,000	1,992	Nickel	17-15/16" x 3-15/16"	2	ETL
ASD-LOFT-FM-20D42BK	20"	42	120	Triac	2,700/3,000/3,500/4,000/5,000	2,475	Black	19-1/8" x 4-1/8"	2	ETL
ASD-LOFT-FM-20D42NK	20"	42	120	Triac	2,700/3,000/3,500/4,000/5,000	2,475	Nickel	19-1/8" x 4-1/8"	2	ETL

WITH RGBW

ASD-LOFT-FM-12D20SM-RGBW-BK	12"	20	120	SMART APP + RC	2,700-6,500 + RGBW	1,220	Black	11-5/16" x 3-3/8"	4	ETL
ASD-LOFT-FM-12D20SM-RGBW-NK	12"	20	120	SMART APP + RC	2,700-6,500 + RGBW	1,220	Nickel	11-5/16" x 3-3/8"	4	ETL
ASD-LOFT-FM-16D28SM-RGBW-BK	16"	28	120	SMART APP + RC	2,700-6,500 + RGBW	1,681	Black	15-5/16" x 3-11/16"	4	ETL
ASD-LOFT-FM-16D28SM-RGBW-NK	16"	28	120	SMART APP + RC	2,700-6,500 + RGBW	1,681	Nickel	15-5/16" x 3-11/16"	4	ETL
ASD-LOFT-FM-20D42SM-RGBW-BK	20"	42	120	SMART APP + RC	2,700-6,500 + RGBW	2,882	Black	19-1/8" x 4-1/8"	2	ETL
ASD-LOFT-FM-20D42SM-RGBW-NK	20"	42	120	SMART APP + RC	2,700-6,500 + RGBW	2,882	Nickel	19-1/8" x 4-1/8"	2	ETL

LED DOUBLE RING FLUSHMOUNT

ASD-LFMDR, ASD-LFMDR-RGBW

Model	Size	Watts	Input Voltage	Dimmable	CCT	Lm	Finish	Dimensions DxH	Pcs. per Carton	Certification
ASD-LFMDR-10D16CC-BK	10"	16	120	Triac	3,000/4,000/5,000	1,041	Black	10-5/16" x 3-1/2"	4	ETL
ASD-LFMDR-10D16CC-NK	10"	16	120	Triac	3,000/4,000/5,000	1,041	Nickel	10-5/16" x 3-1/2"	4	ETL
ASD-LFMDR-12D20CC-BK	12"	20	120	Triac	3,000/4,000/5,000	1,473	Black	11-13/16" x 2-9/16"	4	ETL
ASD-LFMDR-12D20CC-NK	12"	20	120	Triac	3,000/4,000/5,000	1,473	Nickel	11-13/16" x 2-9/16"	4	ETL
ASD-LFMDR-14D21CC-BK	14"	21	120	Triac	3,000/4,000/5,000	1,520	Black	13-3/4" x 2-9/16"	4	ETL
ASD-LFMDR-14D21CC-NK	14"	21	120	Triac	3,000/4,000/5,000	1,520	Nickel	13-3/4" x 2-9/16"	4	ETL
ASD-LFMDR-16D24CC-BK	16"	24	120	Triac	3,000/4,000/5,000	2,291	Black	15-15/16" x 3-1/4"	2	ETL
ASD-LFMDR-16D24CC-BZ	16"	24	120	Triac	3,000/4,000/5,000	2,291	Oil Rubbed Bronze	15-15/16" x 3-1/4"	2	ETL
ASD-LFMDR-16D24CC-NK	16"	24	120	Triac	3,000/4,000/5,000	2,291	Nickel	15-15/16" x 3-1/4"	2	ETL
ASD-LFMDR-18D28CC-BK	18"	28	120	Triac	3,000/4,000/5,000	2,390	Black	17-15/16" x 3-7/8"	2	ETL
ASD-LFMDR-18D28CC-BZ	18"	28	120	Triac	3,000/4,000/5,000	2,390	Oil Rubbed Bronze	17-15/16" x 3-7/8"	2	ETL
ASD-LFMDR-18D28CC-NK	18"	28	120	Triac	3,000/4,000/5,000	2,390	Nickel	17-15/16" x 3-7/8"	2	ETL

120-277V

ASD-LFMDR-MV-12D20CC-NK	12"	20	120-277	Triac	3,000/4,000/5,000	1,580	Nickel	11-13/16" x 3-1/8"	4	ETL
ASD-LFMDR-MV-14D21CC-NK	14"	21	120-277	Triac	3,000/4,000/5,000	1,725	Nickel	14" x 3-9/16"	4	ETL
ASD-LFMDR-MV-16D24CC-NK	16"	24	120-277	Triac	3,000/4,000/5,000	2,118	Nickel	15-3/4" x 3-13/16"	2	ETL
ASD-LFMDR-MV-18D28CC-NK	18"	28	120-277	Triac	3,000/4,000/5,000	2,389	Nickel	17-15/16" x 3-7/8"	2	ETL

120-277V WITH BATTERY BACK-UP

ASD-LFMDR-MV-12D20CC-EM-NK	12"	20	120-277	Triac	3,000/4,000/5,000	1,944	Nickel	11-13/16" x 4-5/16"	4	ETL
ASD-LFMDR-MV-14D21CC-EM-NK	14"	21	120-277	Triac	3,000/4,000/5,000	1,854	Nickel	13-3/4" x 4-11/16"	4	ETL
ASD-LFMDR-MV-16D24CC-EM-NK	16"	24	120-277	Triac	3,000/4,000/5,000	2,116	Nickel	15-3/4" x 4-3/4"	4	ETL

WITH RGBW

ASD-LFMDR-14D21SM-RGBW-NK	14"	21	120	SMART APP + RC	2,700-6,500 + RGBW	1,429	Nickel	13-3/4" x 3-9/16"	4	ETL
ASD-LFMDR-16D24SM-RGBW-NK	16"	24	120	SMART APP + RC	2,700-6,500 + RGBW	1,575	Nickel	15-3/4" x 3-7/8"	2	ETL
ASD-LFMDR-18D28SM-RGBW-NK	18"	28	120	SMART APP + RC	2,700-6,500 + RGBW	1,844	Nickel	17-11/16" x 4-1/16"	2	ETL

LED OVAL DOUBLE RING FLUSHMOUNT

ASD-FMOV, ASD-LFMOV

Model	Size	Watts	Input Voltage	Dimmable	CCT	Lm	Finish	Dimensions LxWxH	Pcs. per Carton	Certification
ASD-FMOV-24D38BK	24"	38	120	Triac	2,700/3,000/3,500/4,000/5,000	2,432	Black	24" x 13-9/16" x 4-5/16"	2	ETL
ASD-FMOV-24D38BZ	24"	38	120	Triac	2,700/3,000/3,500/4,000/5,000	2,432	Bronze	24" x 13-9/16" x 4-5/16"	2	ETL
ASD-FMOV-24D38NK	24"	38	120	Triac	2,700/3,000/3,500/4,000/5,000	3,289	Nickel	24" x 13-9/16" x 4-5/16"	2	ETL
ASD-FMOV-32D50BK	32"	50	120	Triac	2,700/3,000/3,500/4,000/5,000	4,195	Black	32-5/16" x 18-1/8" x 4-5/16"	2	ETL
ASD-FMOV-32D50BZ	32"	50	120	Triac	2,700/3,000/3,500/4,000/5,000	4,195	Bronze	32-5/16" x 18-1/8" x 4-5/16"	2	ETL
ASD-FMOV-32D50NK	32"	50	120	Triac	2,700/3,000/3,500/4,000/5,000	4,195	Nickel	32-5/16" x 18-1/8" x 4-5/16"	2	ETL

120-277V

ASD-LFMOV-MV-32D45CC-BK	32"	45	120-277	Triac	3,000/4,000/5,000	3,750	Black	32-7/16" x 18-1/8" x 4-13/
-------------------------	-----	----	---------	-------	-------------------	-------	-------	----------------------------



LED OVAL EDGE LIT PANEL

ASD-MPO

Model	Size	Watts	Input Voltage	Dimmable	CCT	Lm	Location	Finish	Dimensions LxWxH	Pcs. per Carton	Certification
ASD-MPO-32D45WH	32"	45	120-277	Triac	2,700/3,000/4,000/5,000/6,000	3,368	Wet	White	31-7/8" x 17-13/16" x 1-3/16"	2	ETL



LED ROUND EDGE LIT PANEL

ASD-MPR

Model	Size	Watts	Input Voltage	Dimmable	CCT	Lm	Location	Finish	Dimensions DxDH	Pcs. per Carton	Certification
ASD-MPR-5D10BK	5"	10	120	Triac	2,700/3,000/4,000/5,000/6,000	692	Wet	Black	5-5/16" x 1"	6	ETL
ASD-MPR-5D10WH	5"	10	120	Triac	2,700/3,000/4,000/5,000/6,000	692	Wet	White	5-5/16" x 1"	6	ETL
ASD-MPR-7D15BK	7"	15	120	Triac	2,700/3,000/4,000/5,000/6,000	1,262	Wet	Black	7-1/16" x 1"	6	ETL
ASD-MPR-7D15NK	7"	15	120	Triac	2,700/3,000/4,000/5,000/6,000	1,262	Wet	Nickel	7-1/16" x 1"	6	ETL
ASD-MPR-7D15WH	7"	15	120	Triac	2,700/3,000/4,000/5,000/6,000	1,262	Wet	White	7-1/16" x 1"	6	ETL
ASD-MPR-9D18BK	9"	18	120	Triac	2,700/3,000/4,000/5,000/6,000	1,664	Wet	Black	8-7/8" x 1-3/4"	6	ETL
ASD-MPR-9D18NK	9"	18	120	Triac	2,700/3,000/4,000/5,000/6,000	1,664	Wet	Nickel	8-7/8" x 1-3/4"	6	ETL
ASD-MPR-9D18WH	9"	18	120	Triac	2,700/3,000/4,000/5,000/6,000	1,664	Wet	White	8-7/8" x 1-3/4"	6	ETL
ASD-MPR-12D24BK	12"	24	120	Triac	2,700/3,000/4,000/5,000/6,000	2,145	Wet	Black	11-13/16" x 1"	4	ETL
ASD-MPR-12D24NK	12"	24	120	Triac	2,700/3,000/4,000/5,000/6,000	2,145	Wet	Nickel	11-13/16" x 1"	4	ETL
ASD-MPR-12D24WH	12"	24	120	Triac	2,700/3,000/4,000/5,000/6,000	2,145	Wet	White	11-13/16" x 1"	4	ETL

120-277V

ASD-MPR-MV-12D24BK	12"	24	120-277	Triac	2,700/3,000/4,000/5,000/6,000	2,069	Damp	Black	11-15/16" x 1"	4	ETL
ASD-MPR-MV-12D24WH	12"	24	120-277	Triac	2,700/3,000/4,000/5,000/6,000	2,069	Damp	White	11-15/16" x 1"	4	ETL
ASD-MPR-15D28WH	15"	28	120-277	Triac	2,700/3,000/4,000/5,000/6,000	2,373	Wet	White	14-15/16" x 1-3/16"	2	ETL
ASD-MPR-18D32WH	18"	32	120-277	Triac	2,700/3,000/4,000/5,000/6,000	2,687	Wet	White	17-15/16" x 1-3/16"	2	ETL
ASD-MPR-24D38WH	24"	38	120-277	Triac	2,700/3,000/4,000/5,000/6,000	2,760	Wet	White	24" x 1-3/16"	2	ETL
ASD-MPR-32D45WH	32"	45	120-277	Triac	2,700/3,000/4,000/5,000/6,000	3,902	Wet	White	31-15/16" x 1-3/16"	2	ETL

WITH MOTION SENSOR & PHOTOCELL

ASD-MPR-7N15WH-MS	7"	15	120	No	2,700/3,000/4,000/5,000/6,000	905	Damp	White	7-1/16" x 7/8"	12	ETL
ASD-MPR-9N18WH-MS	9"	18	120	No	2,700/3,000/4,000/5,000/6,000	1,333	Damp	White	8-3/4" x 7/8"	12	ETL
ASD-MPR-12N24WH-MS	12"	24	120	No	2,700/3,000/4,000/5,000/6,000	1,788	Damp	White	12" x 3/4"	4	ETL

WITH BATTERY BACK-UP

ASD-MPR-7D15WH-EM	7"	15	120	Triac	2,700/3,000/4,000/5,000/6,000	1,267	Damp	White	7-1/16" x 1-3/4"	12	ETL
ASD-MPR-9D18WH-EM	9"	18	120	Triac	2,700/3,000/4,000/5,000/6,000	1,664	Damp	White	8-7/8" x 1-3/4"	12	ETL
ASD-MPR-12D24WH-EM	12"	24	120	Triac	2,700/3,000/4,000/5,000/6,000	2,164	Damp	White	12" x 1-3/4"	6	ETL

ACCESSORIES

Sub-plate for 7"	ASD-SP7-MPR-WH	White	7-1/16" x 1-3/4"	12	-
Sub-plate for 9"	ASD-SP9-MPR-WH	White	8-7/8" x 1-1/4"	12	-
Sub-plate for 12"	ASD-SP12-MPR-WH	White	11-13/16" x 1-1/4"	12	-
Retrofit Kit with E26 base and TP24 connector for 5"	ASD-RK4-MPR	-	-	48	-
Retrofit Kit with E26 base and TP24 connector for 7/9/12"	ASD-RK6-MPR	-	-	48	-
Hanging mounting set for 15", 18"	ASD-HS15-MPR-WH	White	12-15/16" x 7-1/16"	4	-
Hanging mounting set for 24"	ASD-HS24-MPR-WH	White	16-7/8" x 7-1/16"	4	-
Hanging mounting set for 32"	ASD-HS32-MPR-WH	White	23-9/16" x 7-1/16"	4	-

LED SQUARE EDGE LIT PANEL

ASD-MPS

Model	Size	Watts	Input Voltage	Dimmable	CCT	Lm	Location	Finish	Dimensions LxWxH	Pcs. per Carton	Certification
ASD-MPS-5D10CC-BK-6PACK	5"	10	120	Triac	3,000/4,000/5,000	744	Damp	Black	5-5/16" x 5-5/16" x 1-1/8"	2	ETL
ASD-MPS-5D10CC-WH-6PACK	5"	10	120	Triac	3,000/4,000/5,000	744	Damp	White	5-5/16" x 5-5/16" x 1-1/8"	2	ETL
ASD-MPS-7D15CC-BK-6PACK	7"	15	120	Triac	3,000/4,000/5,000	1,094	Damp	Black	7-1/16" x 7-1/16" x 1-1/8"	2	ETL
ASD-MPS-7D15CC-WH-6PACK	7"	15	120	Triac	3,000/4,000/5,000	1,094	Damp	White	7-1/16" x 7-1/16" x 1-1/8"	2	ETL
ASD-MPS-9D18CC-BK-6PACK	9"	18	120	Triac	3,000/4,000/5,000	1,452	Damp	Black	8-7/8" x 8-7/8" x 1-1/8"	2	ETL
ASD-MPS-9D18CC-WH-6PACK	9"	18	120	Triac	3,000/4,000/5,000	1,452	Damp	White	8-7/8" x 8-7/8" x 1-1/8"	2	ETL
ASD-MPS-12D24BK	12"	24	120	Triac	2,700/3,000/4,000/5,000/6,000	1,731	Wet	Black	11-13/16" x 11-13/16" x 1-1/8"	4	ETL
ASD-MPS-12D24WH	12"	24	120	Triac	2,700/3,000/4,000/5,000/6,000	1,731	Wet	White	11-13/16" x 11-13/16" x 1-1/8"	4	ETL

ACCESSORIES

Retrofit Kit with E26 base and TP24 connector for 5"	ASD-RK4-MPR	-	-	48	-
Retrofit Kit with E26 base and TP24 connector for 7/9/12"	ASD-RK6-MPR	-	-	48	-



LED DISK LIGHT

ASD-LDS

Model	Size	Watts	Input Voltage	Dimmable	CCT	Lm	Finish	Dimensions DxDH	Pcs. per Carton	Certification
ASD-LDS-4D10BK	4"	10	120	Triac	2,700/3,000/3,500/4,000/5,000	864	Black	5-7/8" x 7/8"	6	ETL / UL / Energy Star / T24 JA8
ASD-LDS-4D10AC-BK-12PACK	4"	10	120	Triac	2,700/3,000/3,500/4,000/5,000	864	Black	5-7/8" x 7/8"	1	ETL / UL / Energy Star / T24 JA8
ASD-LDS-4D10WH	4"	10	120	Triac	2,700/3,000/3,500/4,000/5,000	864	White	5-7/8" x 7/8"	6	ETL / UL / Energy Star / T24 JA8
ASD-LDS-4D10AC-WH-12PACK	4"	10	120	Triac	2,700/3,000/3,500/4,000/5,000	864	White	5-7/8" x 7/8"	1	ETL / UL / Energy Star / T24 JA8
ASD-LDS-6D15BK	6"	15	120	Triac	2,700/3,000/3,500/4,000/5,000	1,245	Black	7-5/16" x 15/16"	6	ETL / UL / Energy Star / T24 JA8
ASD-LDS-6D15MB	6"	15	120	Triac	2,700/3,000/3,500/4,000/5,000	1,293	Matte Black	7-5/16" x 15/16"	6	ETL
ASD-LDS-6D15AC-BK-12PACK	6"	15	120	Triac	2,700/3,000/3,500/4,000/5,000	1,328	Black	7-5/16" x 15/16"	1	ETL / UL / Energy Star / T24 JA8
ASD-LDS-6D15BR	6"	15	120	Triac	2,700/3,000/3,500/4,000/5,000	1,240	Bronze	7-5/16" x 15/16"	6	ETL / UL / Energy Star / T24 JA8
ASD-LDS-6D15NK	6"	15	120	Triac	2,700/3,000/3,500/4,000/5,000	1,245	Nickel	7-5/16" x 15/16"	6	ETL / UL / Energy Star / T24 JA8
ASD-LDS-6D15WH	6"	15	120	Triac	2,700/3,000/3,500/4,000/5,000	1,245	White	7-5/16" x 15/16"	6	ETL / UL / Energy Star / T24 JA8
ASD-LDS-6D15MM	6"	15	120	Triac	2,700/3,000/3,500/4,000/5,000	1,293	Matte White	7-5/16" x 15/16"	6	ETL
ASD-LDS-6D15AC-WH-12PACK	6"	15	120	Triac	2,700/3,000/3,500/4,000/5,000	1,328	White	7-5/16" x 15/16"	1	ETL / UL / Energy Star / T24 JA8

WITH MOTION SENSOR

ASD-LDS-6N15WH-MS	6"	15	120	No	2,700/3,000/3,500/4,000/5,000	1,323	White	7-5/16" x 1-1/4"	6	UL / Energy Star
-------------------	----	----	-----	----	-------------------------------	-------	-------	------------------	---	------------------

ACCESSORIES

J-Box Emergency Battery Back-up kit 13W 120V	ASD-EMK13-LDS	8-4/8" x 5-2/16" x 2-15/16"	6	-
Retrofit Kit with E26 base and TP24 connector for 4"	ASD-RK4-LDS-6PACK	-	8	-
Retrofit Kit with E26 base and TP24 connector for 6"	ASD-RK6-LDS-6PACK	-	8	-

LED ROUND WAFER

ASD-JBR, ASD-JBR-RGBW

Model	Size	Watts	Input Voltage	Dimmable	CCT	Lm	Finish	Dimensions DxDH	Pcs. per Carton	Certification
ASD-JBR-3D6BK	3"	6	120	Triac	2,700/3,000/3,500/4,000/5,000	499	Black	3-5/8" x 7/8"	6	ETL / Energy Star
ASD-JBR-3D6BK-12P	3"	6	120	Triac	2,700/3,000/3,500/4,000/5,000	499	Black	3-5/8" x 7/8"	1	ETL / Energy Star
ASD-JBR-3D6BR-6P	3"	6	120	Triac	2,700/3,000/3,500/4,000/5,000	499	Bronze	3-5/8" x 7/8"	1	ETL / Energy Star
ASD-JBR-3D6NK-6P	3"	6	120	Triac	2,700/3,000/3,500/4,000/5,000	499	Nickel	3-5/8" x 7/8"	1	ETL / Energy Star
ASD-JBR-3D6WH	3"	6	120	Triac	2,700/3,000/3,500/4,000/5,000	499	White	3-5/8" x 7/8"	6	ETL / Energy Star
ASD-JBR-3D6WH-12P	3"	6	120	Triac	2,700/3,000/3,500/4,000/5,000	499	White	3-5/8" x 7/8"	1	ETL / Energy Star
ASD-JBR-4D9BK	4"	9	120	Triac	2,700/3,000/3,500/4,000/5,000	831	Black	4-15/16" x 7/8"	6	ETL / Energy Star
ASD-JBR-4D9BK-12P	4"	9	120	Triac	2,700/3,000/3,500/4,000/5,000	831	Black	4-15/16" x 7/8"	1	ETL / Energy Star
ASD-JBR-4D9BR-6P	4"	9	120	Triac	2,700/3,000/3,500/4,000/5,000	831	Bronze	4-15/16" x 7/8"	1	ETL / Energy Star
ASD-JBR-4D9NK-6P	4"	9	120	Triac	2,700/3,000/3,500/4,000/5,000	831	Nickel	4-15/16" x 7/8"	1	ETL / Energy Star
ASD-JBR-4D9WH	4"	9	120	Triac	2,700/3,000/3,500/4,000/5,000	831	White	4-15/16" x 7/8"	6	ETL / Energy Star
ASD-JBR-4D9WH-12P	4"	9	120	Triac	2,700/3,000/3,500/4,000/5,000	831	White	4-15/16" x 7/8"	1	ETL / Energy Star
ASD-JBR-4D12BK	4"	12	120	Triac	2,700/3,000/3,500/4,000/5,000	1,011	Black	4-15/16" x 7/8"	6	ETL / Energy Star
ASD-JBR-4D12WH	4"	12	120	Triac	2,700/3,000/3,500/4,000/5,000	1,011	White	4-15/16" x 7/8"	6	ETL / Energy Star
ASD-JBR-4D12WH-12P	4"	12	120	Triac	2,700/3,000/3,500/4,000/5,000	1,011	White	4-15/16" x 7/8"	1	ETL / Energy Star
ASD-JBR-6D12BK	6"	12	120	Triac	2,700/3,000/3,500/4,000/5,000	1,040	Black	6-7/8" x 15/16"	6	ETL / Energy Star
ASD-JBR-6D12BK-12P	6"	12	120	Triac	2,700/3,000/3,500/4,000/5,000	1,040	Black	6-7/8" x 15/16"	1	ETL / Energy Star
ASD-JBR-6D12BR-6P	6"	12	120	Triac	2,700/3,000/3,500/4,000/5,000	1,040	Bronze	6-7/8" x 15/1		



LED SQUARE WAFER

ASD-JBS, ASD-JBSR

Model	Size	Watts	Input Voltage	Dimmable	CCT	Lm	Finish	Dimensions LxWxH	Pcs. per Carton	Certification
ASD-JBS-3D8BK-6P	3"	8	120	Triac	2,700/3,000/3,500/4,000/5,000	656	Black	3-1/4" x 3-1/4" x 9/16"	1	ETL/Energy Star /T24 JA8
ASD-JBS-3D8WH-6P	3"	8	120	Triac	2,700/3,000/3,500/4,000/5,000	656	White	3-1/4" x 3-1/4" x 9/16"	1	ETL/Energy Star /T24 JA8
ASD-JBS-4D10BK-6P	4"	10	120	Triac	2,700/3,000/3,500/4,000/5,000	820	Black	4-5/8" x 4-5/8" x 9/16"	1	ETL/Energy Star /T24 JA8
ASD-JBS-4D10WH-6P	4"	10	120	Triac	2,700/3,000/3,500/4,000/5,000	820	White	4-5/8" x 4-5/8" x 9/16"	1	ETL/Energy Star /T24 JA8
ASD-JBS-6D15BK-6P	6"	15	120	Triac	2,700/3,000/3,500/4,000/5,000	1,230	Black	6-9/16" x 6-9/16" x 9/16"	1	ETL/Energy Star /T24 JA8
ASD-JBS-6D15WH-6P	6"	15	120	Triac	2,700/3,000/3,500/4,000/5,000	1,230	White	6-9/16" x 6-9/16" x 9/16"	1	ETL/Energy Star /T24 JA8
ASD-JBS-8D20BK	8"	20	120	Triac	2,700/3,000/3,500/4,000/5,000	1,640	Black	8-11/16" x 8-11/16" x 9/16"	4	ETL/Energy Star /T24 JA8
ASD-JBS-8D20WH	8"	20	120	Triac	2,700/3,000/3,500/4,000/5,000	1,640	White	8-11/16" x 8-11/16" x 9/16"	4	ETL/Energy Star /T24 JA8
ASD-JBS-12D27BK	12"	27	120	Triac	2,700/3,000/3,500/4,000/5,000	2,214	Black	11-9/16" x 11-9/16" x 9/16"	4	ETL/Energy Star /T24 JA8
ASD-JBS-12D27WH	12"	27	120	Triac	2,700/3,000/3,500/4,000/5,000	2,214	White	11-9/16" x 11-9/16" x 9/16"	4	ETL/Energy Star /T24 JA8

WITH ROUND BACK

ASD-JBSR-4D10WH	4"	10	120	Triac	2,700/3,000/3,500/4,000/5,000	872	White	4/7/8" x 4-7/8" x 1-1/8"	6	ETL /T24 JA8
ASD-JBSR-6D15AC-WH	6"	15	120	Triac	2,700/3,000/3,500/4,000/5,000	1,266	White	7-3/16" x 7-3/16" x 1"	6	ETL/Energy Star /T24 JA8

LED ROUND WAFER WITH NIGHT LIGHT

ASD-JBR-NL

Model	Size	Watts	Input Voltage	Dimmable	CCT	Lm	Finish	Dimensions DxH	Pcs. per Carton	Certification
ASD-JBR-NL-4D9BK-6P	4"	9	120	Triac	2,700/3,000/3,500/4,000/5,000 + 2,000	842	Black	4-15/16" x 7/8"	2	ETL/Energy Star /T24 JA8
ASD-JBR-NL-4D9WH-6P	4"	9	120	Triac	2,700/3,000/3,500/4,000/5,000 + 2,000	842	White	4-15/16" x 7/8"	2	ETL/Energy Star /T24 JA8
ASD-JBR-NL-6D12BK-6P	6"	12	120	Triac	2,700/3,000/3,500/4,000/5,000 + 2,000	1,133	Black	6-7/8" x 15/16"	2	ETL/Energy Star /T24 JA8
ASD-JBR-NL-6D12WH-6P	6"	12	120	Triac	2,700/3,000/3,500/4,000/5,000 + 2,000	1,133	White	6-7/8" x 15/16"	2	ETL/Energy Star /T24 JA8

ACCESSORIES

Extension Cord 3PIN 10"	ASD-EC-10A-6PACK	White	10"	10	UL
Extension Cord 3PIN 20"	ASD-EC-20A-6PACK	White	20"	10	UL

LED ROUND CANLESS DOWNLIGHT GIMBAL

ASD-JBR-GB

Model	Size	Watts	Input Voltage	Dimmable	CCT	Lm	Finish	Dimensions DxH	Pcs. per Carton	Certification
ASD-JBR-GB-3D6BK-6P	3"	6	120	Triac	2,700/3,000/3,500/4,000/5,000	541	Black	3-15/16" x 1-1/8"	2	ETL/Energy Star /T24 JA8
ASD-JBR-GB-3D6WH-6P	3"	6	120	Triac	2,700/3,000/3,500/4,000/5,000	541	White	3-15/16" x 1-1/8"	2	ETL/Energy Star /T24 JA8
ASD-JBR-GB-4D9BK-6P	4"	9	120	Triac	2,700/3,000/3,500/4,000/5,000	769	Black	4-13/16" x 1-7/16"	2	ETL/Energy Star /T24 JA8
ASD-JBR-GB-4D9WH-6P	4"	9	120	Triac	2,700/3,000/3,500/4,000/5,000	769	White	4-13/16" x 1-7/16"	2	ETL/Energy Star /T24 JA8
ASD-JBR-GB-6D12BK-6P	6"	12	120	Triac	2,700/3,000/3,500/4,000/5,000	1,216	Black	6-7/8" x 1-3/4"	2	ETL/Energy Star /T24 JA8
ASD-JBR-GB-6D12WH-6P	6"	12	120	Triac	2,700/3,000/3,500/4,000/5,000	1,216	White	6-7/8" x 1-3/4"	2	ETL/Energy Star /T24 JA8

ACCESSORIES

Extension Cord 3PIN 10"	ASD-EC-10A-6PACK	White	10"	10	UL
Extension Cord 3PIN 20"	ASD-EC-20A-6PACK	White	20"	10	UL

LED ROUND WAFER BAFFLE TRIM

ASD-JBRB-MV

Model	Size	Watts	Input Voltage	Dimmable	CCT	Lm	Finish	Dimensions DxH	Pcs. per Carton	Certification
ASD-JBRB-4D9WH	4"	9	120	Triac	2,700/3,000/3,500/4,000/5,000	757	White	4-15/16" x 1-1/4"	6	ETL/Energy Star /T24 JA8
ASD-JBRB-4D9WH-12P	4"	9	120	Triac	2,700/3,000/3,500/4,000/5,000	757	White	4-15/16" x 1-1/4"	1	ETL/Energy Star /T24 JA8
ASD-JBRB-6D12WH	6"	12	120	Triac	2,700/3,000/3,500/4,000/5,000	1,071	White	6-7/8" x 1-1/4"	6	ETL/Energy Star /T24 JA8
ASD-JBRB-6D12WH-12P	6"	12	120	Triac	2,700/3,000/3,500/4,000/5,000	1,071	White	6-7/8" x 1-1/4"	1	ETL/Energy Star /T24 JA8

120-277V

ASD-JBRB-MV-4D12WH	4"	12	120-277	0-10V	2,700/3,000/3,500/4,000/5,000	935	White	5" x 2-3/16"	6	ETL
ASD-JBRB-MV-4D12BK	4"	12	120-277	0-10V	2,700/3,000/3,500/4,000/5,000	935	Black	5" x 2-3/16"	6	ETL
ASD-JBRB-MV-6D15WH	6"	15	120-277	0-10V	2,700/3,000/3,500/4,000/5,000	1,205	White	6-7/8" x 2-3/16"	6	ETL
ASD-JBRB-MV-6D15BK	6"	15	120-277	0-10V	2,700/3,000/3,500/4,000/5,000	1,214	Black	6-7/8" x 2-3/16"	6	ETL/Energy Star /T24 JA8

ACCESSORIES

Battery Back-up kit 8W	BLD-HM08D	10-7/16" x 1-15/16" x 15/16"	10	UL
Battery Back-up kit 15W	BLD-HM15D	12-15/16" x 1-7/16" x 15/16"	10	UL
Battery Back-up kit 15W	ASD-EMA15	14-5/8" x 1-5/8" x 1-7/16"	10	UL / DLC PRM



LED ROUND WAFER FIRE RATED

ASD-JFR, ASD-JFRB

Model	Size	Watts	Input Voltage	Dimmable	CCT	Lm	Finish	Dimensions DxH	Pcs. per Carton	Certification
ASD-JFR-4D12AC-WH	4"	12	120 V	Triac	2,700/3,000/3,500/4,000/5,000	840	White	5" x 2"	12	ETL
ASD-JFR-6D15AC-WH	6"	15	120 V	Triac	2,700/3,000/3,500/4,000/5,000	1,166	White	6-7/8" x 2"	12	ETL

120-277V WITH BAFFLE TRIM

ASD-JFRB-MV-4D12BK	4"	12	120-277 V	0-10V	2,700/3,000/3,500/4,000/5,000	921	Black	5" x 2-3/16"	6	ETL
ASD-JFRB-MV-4D12WH	4"	12	120-277 V	0-10V	2,700/3,000/3,500/4,000/5,000	921	White	5" x 2-3/16"	6	ETL
ASD-JFRB-MV-6D15 BK	6"	15	120-277 V	0-10V	2,700/3,000/3,500/4,000/5,000	1,197	Black	6-7/8" x 2-1/4"	6	ETL
ASD-JFRB-MV-6D15WH	6"	15	120-277 V	0-10V	2,700/3,000/3,500/4,000/5,000	1,197	White	6-7/8" x 2-1/4"	6	ETL

ACCESSORIES

Battery Back-up kit 8W	BLD-HM08D	10-7/16" x 1-15/16" x 15/16"	10	UL
Battery Back-up kit 15W	BLD-HM15D	12-15/16" x 1-7/16" x 15/16"	10	UL
Battery Back-up kit 15W	ASD-EMA15	14-5/8" x 1-5/8" x 1-7/16"	10	UL / DLC PRM

LED WAFER WITH DEEP BAFFLE TRIM

ASD-JBR-DB

Model	Size	Watts	Input Voltage	Dimmable	CCT	Lm	Finish	Dimensions DxH	Pcs. per Carton	Certification
ASD-JBR-DB-4D10BK-6P	4"	10	120	Triac	2,700/3,000/3,500/4,000/5,000	845	Black	5-1/8" x 1-5/8"	2	ETL/Energy Star /T24 JA8
ASD-JBR-DB-4D10WH	4"	10	120	Triac	2,700/3,000/3,500/4,000/5,000	845	White	5-1/8" x 1-5/8"	6	ETL/Energy Star /T24 JA8
ASD-JBR-DB-4D10WH-12P	4"	10	120	Triac	2,700/3,000/3,500/4,000/5,000	845	White	5-1/8" x 1-5/8"	1	ETL/Energy Star /T24 JA8
ASD-JBR-DB-6D15BK-6P	6"	15	120	Triac	2,700/3,000/3,500/4,000/5,000	1,325	Black	7-3/8" x 2-1/16"	2	ETL/Energy Star /T24 JA8
ASD-JBR-DB-6D15WH	6"	15	120	Triac	2,700/3,000/3,500/4,000/5,000	1,325	White	7-3/8" x 2-1/16"	6	ETL/Energy Star /T24 JA8
ASD-JBR-DB-6D15WH-12P	6"	15	120	Triac	2,700/3,000/3,500/4,000/5,000	1,325	White	7-3/8" x 2-1/16"	1	ETL/Energy Star /T24 JA8

NEW CONSTRUCTION MOUNTING PLATE

ASD-MPL-FA, ASD-MPL-FS, ASD-MPL-SC

Description	Model	Holes	Size	Dimensions LxWxH	Pcs. per Carton
New Construction Flat Mounting Plate with Asymmetric holes	ASD-MPLR-346-FA-6PACK	Round	3-4-6"	13-1/4" x 9-1/16" x 1/16"	4
New Construction Flat Mounting Plate with Asymmetric holes	ASD-MPLR18-346-FA-6PACK	Round	3-4-6"	18" x 9-1/16" x 1/16"	4
New Construction Flat Mounting Plate with Asymmetric holes	ASD-MPLR-81012-FA-6PACK	Round	8-10-12"	18-1/2" x 13-3/8" x 1/16"	4
New Construction Flat Mounting Plate with Asymmetric holes	ASD-MPLS-346-FA-6PACK	Square	3-4-6"	13-1/4" x 9-1/16" x 1/16"	4
New Construction Flat Mounting Plate with Asymmetric holes	ASD-MPLS-81012-FA-6PACK	Square	8-10-12"	18-1/2" x 13-3/8" x 1/16"	4
New Construction Flat Mounting Plate with Symmetric holes	ASD-MPLR-346-FS-6PACK	Round	3-4-6"	26" x 8-1/4" x 1/16"	4
New Construction Flat Mounting Plate with Symmetric holes	ASD-MPLR-81012-FS-6PACK	Round	8-10-12"	26" x 13" x 1/16"	4
New Construction Flat Mounting Plate with Symmetric holes	ASD-MPLS-346-FS-6PACK	Square	3-4-6"	26" x 8-1/4" x 1/16"	4
New Construction Flat Mounting Plate with Symmetric holes	ASD-MPLS-81012-FS-6PACK	Square	8-10-12"	26" x 13" x 1/16"	4
New Construction Mounting Plate with holes and Sliding Clips	ASD-MPLR-346-SC-6PACK	Round	3-4-6"	14-3/8" x 10-9/16" x 1-5/8"	2
New Construction Mounting Plate with holes and Sliding Clips	ASD-MPLR-81012-SC-6PACK	Round	8-10-12"	17-11/16" x 13" x 1-9/16"	2
New Construction Mounting Plate with holes and Sliding Clips	ASD-MPLS-346-SC-6PACK	Square	3-4-6"	14-3/8" x 10-9/16" x 1-5/8"	2
New Construction Mounting Plate with holes and Sliding Clips	ASD-MPLS-81012-SC-6PACK	Square	8-10-12"	17-11/16" x 13" x 1-9/16"	2

LED SQUARE DOWNLIGHT RETROFIT KIT

ASD-LRKS

Model	Size	Watts	Input Voltage	Dimmable	CCT	Lm	Finish	Dimensions LxWxH	Pcs. per Carton	Certification
ASD-LRKS-4D9AC-BK-6PACK	4"	8.6	120	Triac	2,700/3,000/3,500/4,000/5,000	709	Black	5" x 5" x 2-1/16"	2	UL
ASD-LRKS-4D9AC-BZ-6PACK	4"	8.6	120	Triac	2,700/3,000/3,500/4,000/5,000	709	Bronze	5" x 5" x 2-1/16"	2	UL
ASD-LRKS-4D9AC-WH-6PACK	4"	8.6	120	Triac	2,700/3,000/3,500/4,000/5,000	709	White	5" x 5" x 2-1/16"	2	UL
ASD-LRKS-6D12AC-BK-6PACK	6"	12	120	Triac	2,700/3,000/3,500/4,000/5,000	1,023	Black	7-5/16" x 7-5/16" x 1-7/8"	2	UL
ASD-LRKS-6D12AC-BZ-6PACK	6"	12	120	Triac	2,700/3,000/3,500/4,000/5,000	1,023	Bronze	7-5/16" x 7-5/16" x 1-7/8"	2	UL
ASD-LRKS-6D12AC-WH-6PACK	6"	12	120	Triac	2,700/3,000/3,500/4,000/5,000	1,023	White	7-5/16" x 7-5/16" x 1-7/8"	2	UL



LED ROUND DOWNLIGHT RETROFIT KIT

ASD-LRKR

Model	Size	Watts	Input Voltage	Dimmable	CCT	Lm	Finish	Dimensions DxH	Pcs. per Carton	Certification
ASD-LRKR-M4D10BK	4"	10	120	Triac	2,700/3,000/3,500/4,000/5,000	849	Black	5-3/16" x 1-11/16"	6	ETL/Energy Star /T24 JA8
ASD-LRKR-M4D10BK-12P	4"	10	120	Triac	2,700/3,000/3,500/4,000/5,000	849	Black	5-3/16" x 1-11/16"	1	ETL/Energy Star /T24 JA8
ASD-LRKR-M4D10BR	4"	10	120	Triac	2,700/3,000/3,500/4,000/5,000	849	Bronze	5-3/16" x 1-11/16"	6	ETL/Energy Star /T24 JA8
ASD-LRKR-M4D10BR-12P	4"	10	120	Triac	2,700/3,000/3,500/4,000/5,000	849	Bronze	5-3/16" x 1-11/16"	1	ETL/Energy Star /T24 JA8
ASD-LRKR-M4D10WH	4"	10	120	Triac	2,700/3,000/3,500/4,000/5,000	849	White	5-3/16" x 1-11/16"	6	ETL/Energy Star /T24 JA8
ASD-LRKR-M4D10WH-12P	4"	10	120	Triac	2,700/3,000/3,500/4,000/5,000	849	White	5-3/16" x 1-11/16"	1	ETL/Energy Star /T24 JA8
ASD-LRKR-M6D12BK	6"	12	120	Triac	2,700/3,000/3,500/4,000/5,000	1,078	Black	7-3/16" x 1-5/8"	6	ETL/Energy Star /T24 JA8
ASD-LRKR-M6D12BK-12P	6"	12	120	Triac	2,700/3,000/3,500/4,000/5,000	1,078	Black	7-3/16" x 1-5/8"	1	ETL/Energy Star /T24 JA8
ASD-LRKR-M6D12BR	6"	12	120	Triac	2,700/3,000/3,500/4,000/5,000	1,078	Bronze	7-3/16" x 1-5/8"	6	ETL/Energy Star /T24 JA8
ASD-LRKR-M6D12BR-12P	6"	12	120	Triac	2,700/3,000/3,500/4,000/5,000	1,078	Bronze	7-3/16" x 1-5/8"	1	ETL/Energy Star /T24 JA8
ASD-LRKR-M6D12WH	6"	12	120	Triac	2,700/3,000/3,500/4,000/5,000	1,078	White	7-3/16" x 1-5/8"	6	ETL/Energy Star /T24 JA8
ASD-LRKR-M6D12WH-12P	6"	12	120	Triac	2,700/3,000/3,500/4,000/5,000	1,078	White	7-3/16" x 1-5/8"	1	ETL/Energy Star /T24 JA8



LED ROUND DOWNLIGHT RETROFIT KIT GIMBAL

ASD-LRK-GB

Model	Size	Watts	Input Voltage	Dimmable	CCT	Lm	Finish	Dimensions LxWxH	Pcs. per Carton	Certification
ASD-LRK-GB-4D10BR	4"	10	120	Triac	2,700/3,000/3,500/4,000/5,000	811	Bronze	5-1/2" x 5-1/2" x 2-1/8"	6	ETL
ASD-LRK-GB-4D10WH	4"	10	120	Triac	2,700/3,000/3,500/4,000/5,000	811	White	5-1/2" x 5-1/2" x 2-1/8"	6	ETL
ASD-LRK-GB-6D15BR	6"	15	120	Triac	2,700/3,000/3,500/4,000/5,000	1,236	Bronze	7-1/2" x 7-1/2" x 2-1/8"	6	ETL
ASD-LRK-GB-6D15WH	6"	15	120	Triac	2,700/3,000/3,500/4,000/5,000	1,236	White	7-1/2" x 7-1/2" x 2-1/8"	6	ETL



LED VANITY LINEAR LOFT

ASD-LOFT-VF

Model	Size	Watts	Input Voltage	Dimmable	CCT	Lm	Finish	Dimensions LxWxH	Pcs. per Carton	Certification
ASD-LOFT-VF-24D25NK	24"	25	120	Triac	2,700/3,000/3,500/4,000/5,000	1,939	Nickel	25-1/2" x 5-1/4" x 3-11/16"	4	ETL
ASD-LOFT-VF-36D30NK	36"	30	120	Triac	2,700/3,000/3,500/4,000/5,000	2,515	Nickel	37-1/16" x 5-1/4" x 3-11/16"	2	ETL
ASD-LOFT-VF-48D35NK	48"	35	120	Triac	2,700/3,000/3,500/4,000/5,000	3,098	Nickel	49" x 5-1/4" x 3-11/16"	2	ETL

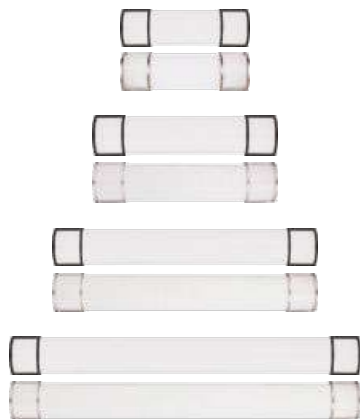

LED VANITY LINEAR LIGHT

ASD-LVF21

Model	Size	Watts	Input Voltage	Dimmable	CCT	Lm	Finish	Dimensions LxWxH	Pcs. per Carton	Certification
ASD-LVF21-18D20CC-BK	18"	20	120	Triac	3,000/4,000/5,000	1,620	Black	19-1/8" x 5-7/8" x 4"	4	ETL
ASD-LVF21-18D20CC-NK	18"	20	120	Triac	3,000/4,000/5,000	1,620	Nickel	19-1/8" x 5-7/8" x 4"	4	ETL
ASD-LVF21-18D20CC-NK-2PACK	18"	20	120	Triac	3,000/4,000/5,000	1,620	Nickel	19-1/8" x 5-7/8" x 4"	2	ETL
ASD-LVF21-24D25CC-BK	24"	25	120	Triac	3,000/4,000/5,000	1,950	Black	25-9/16" x 5-7/8" x 4"	4	ETL
ASD-LVF21-24D25CC-NK	24"	25	120	Triac	3,000/4,000/5,000	1,950	Nickel	25-9/16" x 5-7/8" x 4"	4	ETL
ASD-LVF21-24D25CC-NK-2PACK	24"	25	120	Triac	3,000/4,000/5,000	1,950	Nickel	25-9/16" x 5-7/8" x 4"	1	ETL
ASD-LVF21-36D30CC-BK	36"	30	120	Triac	3,000/4,000/5,000	2,640	Black	37-3/16" x 5-7/8" x 4"	2	ETL
ASD-LVF21-36D30CC-NK	36"	30	120	Triac	3,000/4,000/5,000	2,640	Nickel	37-3/16" x 5-7/8" x 4"	2	ETL
ASD-LVF21-48D35CC-BK	48"	35	120	Triac	3,000/4,000/5,000	3,205	Black	49" x 5-7/8" x 4"	2	ETL
ASD-LVF21-48D35CC-NK	48"	35	120	Triac	3,000/4,000/5,000	3,205	Nickel	49" x 5-7/8" x 4"	2	ETL

120-277V										
ASD-LVF21-MV-18D20NK	18"	20	120-277	Triac	3,000/4,000/5,000	2,259	Nickel	19-1/8" x 5-7/8" x 4"	4	ETL
ASD-LVF21-MV-24D25NK	24"	25	120-277	Triac	3,000/4,000/5,000	2,598	Nickel	25-9/16" x 5-7/8" x 4"	4	ETL

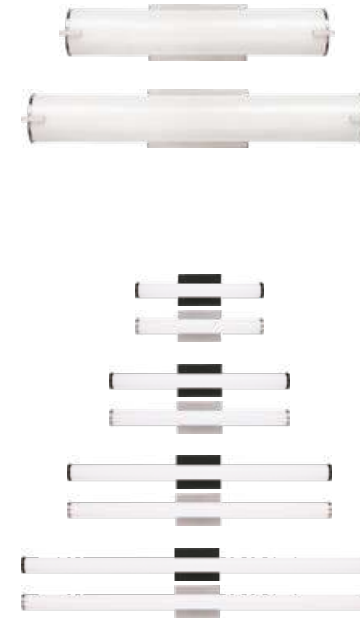

LED VANITY LINEAR LIGHT

ASD-LVF22

Model	Size	Watts	Input Voltage	Dimmable	CCT	Lm	Finish	Dimensions LxWxH	Pcs. per Carton	Certification
ASD-LVF22-18D20CC-NK	18"	20	120	Triac	3,000/4,000/5,000	1,730	Nickel	18-1/16" x 4-1/2" x 4-3/4"	4	ETL
ASD-LVF22-24D25CC-NK	24"	25	120	Triac	3,000/4,000/5,000	2,105	Nickel	24-3/8" x 4-1/2" x 4-3/4"	4	ETL

LED VANITY LINEAR LIGHT

ASD-LVF23

Model	Size	Watts	Input Voltage	Dimmable	CCT	Lm	Finish	Dimensions LxWxH	Pcs. per Carton	Certification
ASD-LVF23-18D20CC-BK	18"	20	120	Triac	3,000/4,000/5,000	1,789	Black	18" x 4-1/2" x 3"	4	ETL
ASD-LVF23-18D20CC-NK	18"	20	120	Triac	3,000/4,000/5,000	1,789	Nickel	18" x 4-1/2" x 3"	4	ETL
ASD-LVF23-18D20-NK-2P	18"	20	120	Triac	3,000/4,000/5,000	1,789	Nickel	18" x 4-1/2" x 3"	2	ETL
ASD-LVF23-24D25CC-BK	24"	25	120	Triac	3,000/4,000/5,000	2,573	Black	24" x 4-1/2" x 3"	4	ETL
ASD-LVF23-24D25CC-NK	24"	25	120	Triac	3,000/4,000/5,000	2,573	Nickel	24" x 4-1/2" x 3"	4	ETL
ASD-LVF23-24D25-NK-2P	24"	25	120	Triac	3,000/4,000/5,000	2,573	Nickel	24" x 4-1/2" x 3"	2	ETL
ASD-LVF23-36D30CC-BK	36"	30	120	Triac	3,000/4,000/5,000	3,141	Black	36" x 4-1/2" x 3"	4	ETL
ASD-LVF23-36D30CC-NK	36"	30	120	Triac	3,000/4,000/5,000	3,141	Nickel	36" x 4-1/2" x 3"	4	ETL
ASD-LVF23-48D35CC-NK	48"	35	120	Triac	3,000/4,000/5,000	3,812	Black	47-5/16" x 4-1/2" x 3"	4	ETL
ASD-LVF23-48D35CC-BK	48"	35	120	Triac	3,000/4,000/5,000	3,812	Nickel	47-5/16" x 4-1/2" x 3"	4	ETL

LED VANITY LIGHT

ASD-LVF24M

Model	Number of lights	Watts	Input Voltage	Dimmable	CCT	Lm	Finish	Dimensions LxWxH	Pcs. per Carton	Certification
ASD-LVF24M-4D23CC-BK	4	23	120	Triac	3,000/4,000/5,000	1,297	Black	24" x 5-1/8" x 3-3/16"	2	ETL
ASD-LVF24M-4D23CC-CH	4	23	120	Triac	3,000/4,000/5,000	1,297	Chrome	24" x 5-1/8" x 3-3/16"	2	ETL
ASD-LVF24M-6D35CC-BK	6	35	120	Triac	3,000/4,000/5,000	2,025	Black	36" x 5-1/8" x 3-3/16"	2	ETL
ASD-LVF24M-6D35CC-CH	6	35	120	Triac	3,000/4,000/5,000	2,025	Chrome	36" x 5-1/8" x 3-3/16"	2	ETL



VANITY LIGHT & MINI-PENDANT

ASD-VF44, ASD-MP44

Model	Type	Bulb Type	Voltage	Finish	Shade	Dimensions LxWxH	Pcs. per Carton	Certification
ASD-VF44-2l-2660-NK	Vanity Light	2 x E26 60W max	120 V	Nickel	Opal Glass	12-5/8" x 6-3/8" x 7-13/16"	6	ETL
ASD-VF44-3l-2660-BK	Vanity Light	3 x E26 60W max	120 V	Black	Opal Glass	20-1/2" x 6-3/8" x 7-13/16"	4	ETL
ASD-VF44-3l-2660-NK	Vanity Light	3 x E26 60W max	120 V	Nickel	Opal Glass	20-1/2" x 6-5/16" x 7-13/16"	4	ETL
ASD-VF44-4l-2660-NK	Vanity Light	4 x E26 60W max	120 V	Nickel	Opal Glass	28-3/8" x 6-3/8" x 7-13/16"	4	ETL
ASD-MP44-1l-2660-BK	Mini-Pendant	1 x E26 60W max	120 V	Black	Opal Glass	4-3/4" x 4-3/4" x 51-3/16"	12	ETL
ASD-MP44-1l-2660-NK	Mini-Pendant	1 x E26 60W max	120 V	Nickel	Opal Glass	4-3/4" x 4-3/4" x 51-3/16"	12	ETL



VANITY LIGHT & MINI-PENDANT

ASD-VF45, ASD-MP45

Model	Type	Bulb Type	Voltage	Finish	Shade	Dimensions LxWxH	Pcs. per Carton	Certification
ASD-VF45-2l-2660-NK	Vanity Light	2 x E26 60W max	120 V	Nickel	Opal Glass	12-7/16" x 6-1/8" x 7-9/16"	6	ETL
ASD-VF45-3l-2660-NK	Vanity Light	3 x E26 60W max	120 V	Nickel	Opal Glass	20-1/2" x 6-1/8" x 7-9/16"	4	ETL
ASD-MP45-1l-2660-NK	Mini-Pendant	1 x E26 60W max	120 V	Nickel	Opal Glass	4-3/4" x 4-3/4" x 10-1/4"	12	ETL





LED WALL SCONCE LOFT

ASD-LOFT-WS

Model	Size	Watts	Input Voltage	Dimmable	CCT	Lm	Finish	Dimensions LxWxH	Pcs. per Carton	Certification
ASD-LOFT-WS-12D15BK	12"	15	120 V	Triac	2,700/3,000/3,500/4,000/5,000	1,148	Black	12-11/16" x 5-1/4" x 3-11/16"	4	ETL
ASD-LOFT-WS-12D15NK	12"	15	120 V	Triac	2,700/3,000/3,500/4,000/5,000	1,148	Nickel	12-11/16" x 5-1/4" x 3-11/16"	4	ETL



LED WALL SCONCE

ASD-LWS-11

Model	Size	Watts	Input Voltage	Dimmable	CCT	Lm	Finish	Dimensions LxWxH	Pcs. per Carton	Certification
ASD-LWS-11-D15CC-BK	10"	15	120	Triac	3,000/4,000/5,000	1,107	Black	9-13/16" x 7" x 3-5/16"	4	ETL
ASD-LWS-11-D15CC-BZ	10"	15	120	Triac	3,000/4,000/5,000	1,107	Bronze	9-13/16" x 7" x 3-5/16"	4	ETL
ASD-LWS-11-D15CC-NK	10"	15	120	Triac	3,000/4,000/5,000	1,107	Nickel	9-13/16" x 7" x 3-5/16"	4	ETL
ASD-LWS-11-D15CC-NK-2PACK	10"	15	120	Triac	3,000/4,000/5,000	1,107	Nickel	9-13/16" x 7" x 3-5/16"	2	ETL
ASD-LWS-11-14D20CC-BK	14"	20	120	Triac	3,000/4,000/5,000	2,097	Black	14" x 7" x 3-1/4"	2	ETL
ASD-LWS-11-14D20CC-NK	14"	20	120	Triac	3,000/4,000/5,000	2,097	Nickel	14" x 7" x 3-1/4"	2	ETL
ASD-LWS-11-18D20CC-NK	18"	20	120	Triac	3,000/4,000/5,000	2,193	Nickel	18" x 7" x 3-1/4"	2	ETL



LED WALL SCONCE

ASD-LWS12

Model	Size	Watts	Input Voltage	Dimmable	CCT	Lm	Finish	Dimensions LxWxH	Pcs. per Carton	Certification
ASD-LWS12-8D10AC-BK	8"	10	120	Triac	2,700/3,000/3,500/4,000/5,000	611	Black	8-11/16" x 4-3/4" x 1-7/8"	2	ETL
ASD-LWS12-8D10AC-NK	8"	10	120	Triac	2,700/3,000/3,500/4,000/5,000	611	Nickel	8-11/16" x 4-3/4" x 1-7/8"	2	ETL
ASD-LWS12-12D12AC-BK	12"	12	120	Triac	2,700/3,000/3,500/4,000/5,000	861	Black	11-7/16" x 4-3/4" x 1-3/4"	2	UL
ASD-LWS12-12D12AC-NK	12"	12	120	Triac	2,700/3,000/3,500/4,000/5,000	861	Nickel	11-7/16" x 4-3/4" x 1-3/4"	2	UL
ASD-LWS12-14D24AC-BK	14"	24	120	Triac	2,700/3,000/3,500/4,000/5,000	1,848	Black	14-3/16" x 5-7/8" x 2-5/16"	2	ETL
ASD-LWS12-14D24AC-NK	14"	24	120	Triac	2,700/3,000/3,500/4,000/5,000	1,848	Nickel	14-3/16" x 5-7/8" x 2-5/16"	2	ETL



LED UNDER CABINET LINEAR LIGHT

ASD-UCL

Model	Size	Watts	Input Voltage	Dimmable	CCT	Lm	Finish	Dimensions LxWxH	Pcs. per Carton	Certification
ASD-UCL-12D5CC-WH	12"	5	120	Triac	2,700/3,000/4,000	406	White	12" x 3-11/16" x 1"	20	UL
ASD-UCL-18D8CC-WH	18"	8	120	Triac	2,700/3,000/4,000	548	White	18" x 3-11/16" x 1"	20	UL
ASD-UCL-24D12CC-WH	24"	12	120	Triac	2,700/3,000/4,000	874	White	24" x 3-11/16" x 1"	12	UL
ASD-UCL-32D16CC-WH	32"	16	120	Triac	2,700/3,000/4,000	1,131	White	32" x 3-11/16" x 1"	12	UL
ASD-UCL-40D20CC-WH	40"	20	120	Triac	2,700/3,000/4,000	1,532	White	40" x 3-11/16" x 1"	12	UL
ASD-UCL-48D24CC-WH	48"	24	120	Triac	2,700/3,000/4,000	1,781	White	48" x 3-11/16" x 1"	6	UL



LED UNDER CABINET SWIVEL LIGHT

ASD-UCS

Model	Size	Watts	Input Voltage	Dimmable	CCT	Lm	Finish	Dimensions LxWxH	Pcs. per Carton	Certification
ASD-UCS-12D5CC-BZ	12"	5	120	Triac	2,700/3,000/4,000	396	Bronze	12" x 3-5/8" x 1"	20	UL
ASD-UCS-12D5CC-WH	12"	5	120	Triac	2,700/3,000/4,000	396	White	12" x 3-5/8" x 1"	20	UL
ASD-UCS-18D8CC-BZ	18"	8	120	Triac	2,700/3,000/4,000	613	Bronze	18" x 3-5/8" x 1"	20	UL
ASD-UCS-18D8CC-WH	18"	8	120	Triac	2,700/3,000/4,000	613	White	18" x 3-5/8" x 1"	20	UL
ASD-UCS-24D12CC-BZ	24"	12	120	Triac	2,700/3,000/4,000	933	Bronze	24" x 3-5/8" x 1"	12	UL
ASD-UCS-24D12CC-WH	24"	12	120	Triac	2,700/3,000/4,000	933	White	24" x 3-5/8" x 1"	12	UL
ASD-UCS-32D16CC-BZ	32"	16	120	Triac	2,700/3,000/4,000	1,328	Bronze	31-7/8" x 3-5/8" x 1"	12	UL
ASD-UCS-32D16CC-WH	32"	16	120	Triac	2,700/3,000/4,000	1,328	White	31-7/8" x 3-5/8" x 1"	12	UL
ASD-UCS-40D20CC-WH	40"	20	120	Triac	2,700/3,000/4,000	1,567	White	40-3/16" x 3-5/8" x 1"	6	UL
ASD-UCS-48D24CC-WH	48"	24	120	Triac	2,700/3,000/4,000	1,744	White	48" x 3-5/8" x 1"	6	UL



LED UNDER CABINET BULLNOSE LIGHT

ASD-UBN

Model	Size	Watts	Input Voltage	Dimmable	CCT	Lm	Finish	Dimensions LxWxH	Pcs. per Carton	Certification
ASD-UBN-12BR	12"	5	120	Triac	2,700/3,000/3,500/4,000/5,000	443	Bronze	12" x 3-1/2" x 1-1/8"	20	UL
ASD-UBN-12WH	12"	5	120	Triac	2,700/3,000/3,500/4,000/5,000	443	White	12" x 3-1/2" x 1-1/8"	20	UL
ASD-UBN-12WH-2P	12"	5	120	Triac	2,700/3,000/3,500/4,000/5,000	443	White	12" x 3-1/2" x 1-1/8"	10	UL
ASD-UBN-18BR	18"	10	120	Triac	2,700/3,000/3,500/4,000/5,000	807	Bronze	18" x 3-1/2" x 1-1/8"	20	UL
ASD-UBN-18WH	18"	10	120	Triac	2,700/3,000/3,500/4,000/5,000	807	White	18" x 3-1/2" x 1-1/8"	20	UL
ASD-UBN-18WH-2P	18"	10	120	Triac	2,700/3,000/3,500/4,000/5,000	807	White	18" x 3-1/2" x 1-1/8"	10	UL
ASD-UBN-24BR	24"	12	120	Triac	2,700/3,000/3,500/4,000/5,000	1,051	Bronze	24" x 3-1/2" x 1-1/8"	12	UL
ASD-UBN-24WH	24"	12	120	Triac	2,700/3,000/3,500/4,000/5,000	1,051	White	24" x 3-1/2" x 1-1/8"	12	UL
ASD-UBN-24WH-2P	24"	12	120	Triac	2,700/3,000/3,500/4,000/5,000	1,051	White	24" x 3-1/2" x 1-1/8"	6	UL
ASD-UBN-32WH	32"	16	120	Triac	2,700/3,000/3,500/4,000/5,000	1,436	White	32-1/4" x 3-1/2" x 1-1/8"	12	UL
ASD-UBN-40WH	40"	20	120	Triac	2,700/3,000/3,500/4,000/5,000	1,814	White	40" x 3-1/2" x 1-1/8"	6	UL
ASD-UBN-48WH	48"	24	120	Triac	2,700/3,000/3,500/4,000/5,000	2,087	White	48-1/16" x 3-1/2" x 1-1/8"	6	UL



LED DOUBLE SIDE EXIT SIGN RED

ASD-ESD-RW

Model	Watts	Battery Back-up Power	Input Voltage	Dimmable	Dimensions LxWxH	Pcs. per Carton	Certification
ASD-ESD-RW	1	1	120/277	No	11-5/8" x 7-3/16" x 1-9/16"	6	UL



LED EDGE-LIT TRANSPARENT EXIT SIGN RED

ASD-EXT-R

Model	Watts	Battery Back-up Power	Input Voltage	Dimmable	Dimensions LxWxH	Pcs. per Carton	Certification
ASD-EXT-R	3	3	120/277	No	12-5/16" x 9-7/8" x 1-7/8"	6	UL



LED EXIT SIGNS RED WITH EMERGENCY LIGHTS

ASD-EXL

Model	Watts	Power of Side Lamps	Battery Back-up Power	Input Voltage	Dimmable	CCT	Lm	Shape of head	Dimensions LxWxH	Pcs. per Carton	Certification
ASD-EXL-2RL-RW	2.2	2 x 1.2	2.5	120-277	No	4,000	169	Round	18-1/16" x 7-3/16" x 2-13/16"	6	UL
ASD-EXL-2SL-RW	2.2	2 x 1.2	3.6	120-277	No	4,000	149	Square	20-1/4" x 7-15/16" x 3-15/16"	6	UL



LED EMERGENCY LIGHTS

ASD-EML-2RL, ASD-EML-2SL

Model	Power of Side Lamps	Battery Back-up Power	Input Voltage	Dimmable	CCT	Lm	Shape of head	Dimensions LxWxH	Pcs. per Carton	Certification
ASD-EML-2RL-W	2 x 1.2	2.5	120-277	No	4,000	215	Round	9-13/16" x 4-1/8" x 2-11/16"	6	UL
ASD-EML-2RS-W	2 x 1.2	2.5	120-277	No	4,000	225	Square	13-11/16" x 4-1/2" x 3-7/16"	6	UL

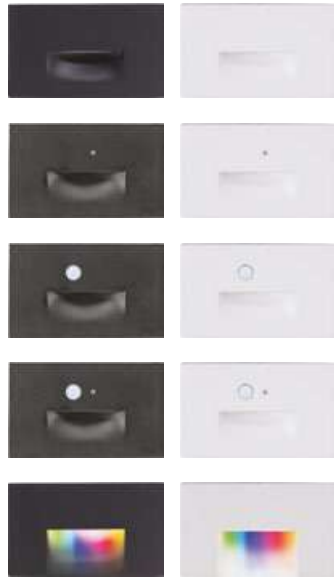

LED STEP LIGHT

ASD-LSTL, ASD-STLA-RGBW

Model	Watts	Input Voltage	Dimmable	CCT	Lm	Finish	Dimensions LxWxH	Pcs. per Carton	Certification
ASD-LSTL-H01W-D3CC-BK-4PACK	3	120	Triac	3,000/4,000/5,000	114	Black	4-3/4" x 1-9/16" x 2-13/16"	3	ETL
ASD-LSTL-H01W-D3CC-WH-4PACK	3	120	Triac	3,000/4,000/5,000	114	White	4-3/4" x 1-9/16" x 2-13/16"	3	ETL

WITH PHOTOCELL

ASD-LSTL-H01W-N3CC-PC-BK	3	120	No	3,000/4,000/5,000	114	Black	4-3/4" x 1-9/16" x 2-13/16"	4	ETL
ASD-LSTL-H01W-N3CC-PC-WH	3	120	No	3,000/4,000/5,000	114	White	4-3/4" x 1-9/16" x 2-13/16"	4	ETL

WITH MOTION SENSOR

ASD-LSTL-H01W-N3CC-MS-BK	3	120	No	3,000/4,000/5,000	114	Black	4-3/4" x 1-3/4" x 2-13/16"	4	ETL
ASD-LSTL-H01W-N3CC-MS-WH	3	120	No	3,000/4,000/5,000	114	White	4-3/4" x 1-3/4" x 2-13/16"	4	ETL

WITH PHOTOCELL & MOTION SENSOR

ASD-LSTL-H01W-N3CC-PC-MS-BK	3	120	No	3,000/4,000/5,000	114	Black	4-3/4" x 1-3/4" x 2-13/16"	4	ETL
ASD-LSTL-H01W-N3CC-PC-MS-WH	3	120	No	3,000/4,000/5,000	114	White	4-3/4" x 1-3/4" x 2-13/16"	4	ETL

WITH RGBW

ASD-STLA-3SM-RGBW-BK-6P	3	120	SMART APP	2,700 – 6,500 + RGBW	58	Black	4-3/4" x 1-9/16" x 2-13/16"	4	ETL
ASD-STLA-3SM-RGBW-WH-6P	3	120	SMART APP	2,700 – 6,500 + RGBW	58	White	4-3/4" x 1-9/16" x 2-13/16"	4	ETL



LED SWIVEL HARDSCAPE LIGHT

ASD-HSL5, ASD-HSL5-RGB

Model	Size	Watts	Input Voltage	Dimmable	CCT	Lm	Finish	Dimensions LxWxH	Pcs. per Carton	Certification
ASD-HSL5-4N2BR-4P	4'	2	12	No	2,200/2,700/3,000/4,000/5,000	135	Bronze	4-1/8" x 2-15/16" x 7/8"	2	ETL
ASD-HSL5-7N5BR-4P	7'	4.5	12	No	2,200/2,700/3,000/4,000/5,000	301	Bronze	6-15/16" x 2-15/16" x 7/8"	2	ETL
ASD-HSL5-12N5BR-2P	12'	5	12	No	2,200/2,700/3,000/4,000/5,000	334	Bronze	12-3/16" x 2-15/16" x 7/8"	2	ETL

WITH RGBW

ASD-HSL5-4-2SM-RGB-BR-8P	4'	1.5	12	SMART APP	2,700 – 6,500 + RGBW	50	Bronze	4-1/2" x 2-15/16" x 1"	2	ETL
ASD-HSL5-7-3SM-RGB-BR-8P	7'	3	12	SMART APP	2,700 – 6,500 + RGBW	107	Bronze	6-15/16" x 2-15/16" x 1"	2	ETL
ASD-HSL5-12-5SM-RGB-BR-8P	12'	5	12	SMART APP	2,700 – 6,500 + RGBW	159	Bronze	12-7/16" x 2-15/16" x 1"	1	ETL



LED OUTDOOR WALL SCONCE

ASD-OLWS-21, ASD-OLWS-21-RGBW

Model	Size	Watts	Input Voltage	Dimmable	CCT	Lm	Finish	Dimensions LxWxH	Pcs. per Carton	Certification
ASD-OLWS-21-MV-10D15CC-BK	10"	15	120-277	Triac	3,000/4,000/5,000	1,361	Black	10" x 7" x 3-1/4"	2	ETL
ASD-OLWS-21-MV-10D15CC-BZ	10"	15	120-277	Triac	3,000/4,000/5,000	1,361	Bronze	10" x 7" x 3-1/4"	2	ETL
ASD-OLWS-21-MV-10D15CC-NK	10"	15	120-277	Triac	3,000/4,000/5,000	1,361	Nickel	10" x 7" x 3-1/4"	2	ETL
ASD-OLWS-21-MV-18D20CC-BK	18"	20	120-277	Triac	3,000/4,000/5,000	2,457	Black	17-15/16" x 7" x 3-1/4"	2	ETL
ASD-OLWS-21-MV-18D20CC-BZ	18"	20	120-277	Triac	3,000/4,000/5,000	2,457	Bronze	17-15/16" x 7" x 3-1/4"	2	ETL
ASD-OLWS-21-MV-18D20CC-NK	18"	20	120-277	Triac	3,000/4,000/5,000	2,457	Nickel	17-15/16" x 7" x 3-1/4"	2	ETL
ASD-OLWS-21-MV-24D25CC-BK	24"	25	120-277	Triac	3,000/4,000/5,000	3,017	Black	23-13/16" x 7" x 3-1/4"	2	ETL
ASD-OLWS-21-MV-24D25CC-BZ	24"	25	120-277	Triac	3,000/4,000/5,000	3,017	Bronze	23-13/16" x 7" x 3-1/4"	2	ETL
ASD-OLWS-21-MV-24D25CC-NK	24"	25	120-277	Triac	3,000/4,000/5,000	3,017	Nickel	23-13/16" x 7" x 3-1/4"	2	ETL
ASD-OLWS-21-MV-36D30CC-BK	36"	30	120-277	Triac	3,000/4,000/5,000	3,268	Black	36" x 7" x 3-1/4"	2	ETL
ASD-OLWS-21-MV-36D30CC-NK	36"	30	120-277	Triac	3,000/4,000/5,000	3,268	Nickel	36" x 7" x 3-1/4"	2	ETL

WITH PHOTOCELL

ASD-OLWS-21-MV-10N15BK-PC	10"	15	120-277	No	3,000/4,000/5,000	1,281	Black	10-7/16" x 7" x 3-1/4"	2	ETL
ASD-OLWS-21-MV-10N15NK-PC	10"	15	120-277	No	3,000/4,000/5,000	1,281	Nickel	10-7/16" x 7" x 3-1/4"	2	ETL

WITH MOTION SENSOR

ASD-OLWS-21-10N15BK-MS	10"	15	120-277	No	3,000/4,000/5,000	1,172	Black	9-15/16" x 7" x 3-9/16"	4	ETL
ASD-OLWS-21-10N15NK-MS	10"	15	120-277	No	3,000/4,000/5,000	1,172	Nickel	9-15/16" x 7" x 3-9/16"	4	ETL
ASD-OLWS-21-18N20BK-MS	18"	20	120-277	No	3,000/4,000/5,000	2,002	Black	17-15/16" x 7" x 3-9/16"	2	ETL
ASD-OLWS-21-18N20NK-MS	18"	20	120-277	No	3,000/4,000/5,000	2,002	Nickel	17-15/16" x 7" x 3-9/16"	2	ETL

WITH RGBW

ASD-OLWS-21-MV-10D15SM-RGBW-BK	10"	15	120-277	SMART APP	2,700 – 6,500 + RGBW	1,188	Black	10" x 7" x 3-1/4"	2	ETL
ASD-OLWS-21-MV-10D15SM-RGBW-NK	10"	15	120-277	SMART APP	2,700 – 6,500 + RGBW	1,188	Nickel	10" x 7" x 3-1/4"	2	ETL
ASD-OLWS-21-MV-24D23SM-RGBW-BK	24"	23	120-277	SMART APP	2,700 – 6,500 + RGBW	2,274	Black	23-13/16" x 7" x 3-1/4"	2	ETL
ASD-OLWS-21-MV-24D23SM-RGBW-NK	24"	23	120-277	SMART APP	2,700 – 6,500 + RGBW	2,274	Nickel	23-13/16" x 7" x 3-1/4"	2	ETL



LED OUTDOOR WALL SCONCE WITH GRID

ASD-OLWS-21GR

Model	Size	Watts	Input Voltage	Dimmable	CCT	Lm	Finish	Dimensions LxWxH	Pcs. per Carton	Certification
ASD-OLWS-21GR-MV-24D25BK	24"	25	120-277	Triac	3,000/4,000/5,000	2,183	Black	23-11/16" x 6-1/2" x 3"	2	ETL
ASD-OLWS-21GR-MV-24D25NK	24"	25	120-277	Triac	3,000/4,000/5,000	2,183	Nickel	23-11/16" x 6-1/2" x 3"	2	ETL
ASD-OLWS-21GR-MV-36D30BK	36"	30	120-277	Triac	3,000/4,000/5,000	2,465	Black	35-7/8" x 6-1/2" x 3"	2	ETL
ASD-OLWS-21GR-MV-36D30NK	36"	30	120-277	Triac	3,000/4,000/5,000	2,465	Nickel	35-7/8" x 6-1/2" x 3"	2	ETL

LED OUTDOOR WALL SCONCE

ASD-OLWS-22

Model	Size	Watts	Input Voltage	Dimmable	CCT	Lm	Finish	Dimensions LxWxH	Pcs. per Carton	Certification
ASD-OLWS-22-MV-12N15CC-BZ	12"	15	120-277	No	3,000/4,000/5,000	1,010	Oil Rubbed Bronze	12" x 6-1/8" x 4"	4	ETL
ASD-OLWS-22-MV-18N20CC-BK	18"	20	120-277	No	3,000/4,000/5,000	1,515	Black	17-15/16" x 6-1/8" x 4"	4	ETL
ASD-OLWS-22-MV-18N20CC-BZ	18"	20	120-277	No	3,000/4,000/5,000	1,515	Oil Rubbed Bronze	17-15/16" x 6-1/8" x 4"	4	ETL
ASD-OLWS-22-MV-24N23CC-BK	24"	23	120-277	No	3,000/4,000/5,000	1,970	Black	24-1/16" x 6-1/8" x 4"	4	ETL
ASD-OLWS-22-MV-24N23CC-BZ	24"	23	120-277	No	3,000/4,000/5,000	1,970	Oil Rubbed Bronze	24-1/16" x 6-1/8" x 4"	4	ETL
ASD-OLWS-22-MV-36N28CC-BK	36"	28	120-277	No	3,000/4,000/5,000	2,690	Matte Black	36-1/16" x 6-1/8" x 4"	4	ETL

LED OUTDOOR WALL SCONCE

ASD-OLWS-23, ASD-OLWS23-RGBW

Model	Size	Watts	Input Voltage	Dimmable	CCT	Lm	Finish	Dimensions LxWxH	Pcs. per Carton	Certification
ASD-OLWS-23-8D12CC-BK	8"	12	120	Triac	3,000/4,000/5,000	909	Black	8" x 6" x 3-1/8"	4	ETL
ASD-OLWS-23-14D20CC-BK	14"	20	120	Triac	3,000/4,000/5,000	1,909	Black	14" x 6" x 3-1/8"	4	ETL
ASD-OLWS23-24D30CC-BK	24"	30	120	Triac	3,000/4,000/5,000	2,600	Black	24" x 6" x 3-1/8"	4	ETL

WITH PHOTOCELL

ASD-OLWS-23-14N20CC-PC-BK	14"	20	120	No	3,000/4,000/5,000	1,909	Black	14-5/8" x 6" x 3-1/8"	4	ETL
---------------------------	-----	----	-----	----	-------------------	-------	-------	-----------------------	---	-----

WITH RGBW

ASD-OLWS23-8D12SM-RGBW-BK	8"	12	120-277	SMART APP	2,700 – 6,500 + RGBW	839	Black	8" x 6" x 3-1/8"	4	ETL
ASD-OLWS23-14D20SM-RGBW-BK	14"	20	120-277	SMART APP	2,700 – 6,500 + RGBW	1,829	Black	14" x 6" x 3-1/8"	4	ETL
ASD-OLWS23-24D30SM-RGBW-BK	24"	30	120-277	SMART APP	2,700 – 6,500 + RGBW	2,236	Black	24" x 6" x 3-1/8"	4	ETL

LED OUTDOOR WALL SCONCE

ASD-LWS26S, ASD-LWS26S-RGBW

Model	Size	Watts	Input Voltage	Dimmable	CCT	Lm	Finish	Dimensions LxWxH	Pcs. per Carton	Certification
ASD-LWS26S-13D12BK	13"	11.5	120	Triac	3,000/4,000/5,000	566	Black	13-3/4" x 4-3/4" x 2-1/2"	2	ETL
ASD-LWS26S-13D12WH	13"	12	120	Triac	3,000/4,000/5,000	566	White	13-3/4" x 4-3/4" x 2-1/2"	2	ETL
ASD-LWS26S-18D12BK	18"	11.5	120	Triac	3,000/4,000/5,000	495	Black	17-15/16" x 4-3/4" x 2-1/2"	2	ETL
ASD-LWS26S-18D12WH	18"	11.5	120	Triac	3,000/4,000/5,000	495	White	17-15/16" x 4-3/4" x 2-1/2"	2	ETL

120-277

ASD-LWS26S-MV-24D20CC-BK	24"	20	120-277	Triac	3,000/4,000/5,000	581	Black	24" x 4-3/4" x 2-15/16"	2	ETL
ASD-LWS26S-MV-24D20CC-WH	24"	12	120-277	Triac	3,000/4,000/5,000	581	Black	24" x 4-3/4" x 2-15/16"	2	ETL

WITH PHOTOCELL

ASD-LWS26S-13N12BK-PC	13"	11.5	120	No	3,000/4,000/5,000	566	Black	13-3/4" x 4-3/4" x 2-1/2"	2	ETL
ASD-LWS26S-18N12BK-PC	18"	11.5	120	No	3,000/4,000/5,000	495	Black	17-15/16" x 4-3/4" x 2-1/2"	2	ETL
ASD-LWS26S-24N12BK-PC	24"	11.5	120	No	3,000/4,000/5,000	605	Black	24" x 4-3/4" x 2-7/8"	2	ETL

WITH RGBW

ASD-LWS26-18D9SM-RGBW-BK	18"	8.5
--------------------------	-----	-----



LED OUTDOOR WALL SCONCE

ASD-LWS28S

Model	Size	Watts	Input Voltage	Dimmable	CCT	Lm	Finish	Dimensions LxWxH	Pcs. per Carton	Certification
ASD-LWS28S-12D22CC-BK	12"	22	120	Triac	3,000/4,000/5,000	485	Black	11-13/16" x 5-1/2" x 2-3/16"	4	ETL

120-277

ASD-LWS28S-MV-18D22CC-BK	18"	22	120-277	Triac	3,000/4,000/5,000	520	Black	18-1/8" x 5-1/2" x 2-3/16"	2	ETL
ASD-LWS28S-MV-18D22WH	18"	22	120-277	Triac	3,000/4,000/5,000	520	White	18-1/8" x 5-1/2" x 2-3/16"	2	ETL
ASD-LWS28S-MV-24D22CC-BK	24"	22	120-277	Triac	3,000/4,000/5,000	531	Black	24" x 5-1/2" x 2-3/16"	2	ETL
ASD-LWS28S-MV-24D22WH	24"	22	120-277	Triac	3,000/4,000/5,000	531	White	24" x 5-1/2" x 2-3/16"	2	ETL

WITH RGBW

ASD-LWS28S-MV-18D22CC-RGBW-BK	18"	22	120-277	SMART APP	2,700 - 6,500 + RGBW	408	Black	18-1/8" x 5-1/2" x 2-1/4"	2	ETL
ASD-LWS28S-MV-24D22CC-RGBW-BK	24"	22	120-277	SMART APP	2,700 - 6,500 + RGBW	432	Black	24" x 5-1/2" x 2-1/4"	2	ETL

LED OUTDOOR WALL SCONCE WITH WIDE ACRYLIC

ASD-LWS27A, ASD-LWS27A-RGBW

Model	Size	Watts	Input Voltage	Dimmable	CCT	Lm	Dimensions LxWxH	Pcs. per Carton	Certification
ASD-LWS27A-18D18BK	18"	18	120-277	Triac	3,000/4,000/5,000	1,573	18" x 5-7/8" x 1-13/16"	2	ETL
ASD-LWS27A-24D24BK	24"	24	120-277	Triac	3,000/4,000/5,000	2,001	24" x 5-7/8" x 1-13/16"	2	ETL
ASD-LWS27A-36D30BK	36"	30	120-277	Triac	3,000/4,000/5,000	2,356	36" x 5-7/8" x 1-13/16"	2	ETL
ASD-LWS27A-48D36BK	48"	36	120-277	Triac	3,000/4,000/5,000	2,980	48" x 5-7/8" x 1-13/16"	1	ETL
ASD-LWS27A-72D40BK	72"	40	120-277	Triac	3,000/4,000/5,000	3,620	72" x 5-7/8" x 1-13/16"	1	ETL

WITH RGBW

ASD-LWS27A-18D12SM-RGBW-BK	18"	12	120-277	SMART APP	2,700 - 6,500 + RGBW	590	18" x 5-7/8" x 1-13/16"	2	ETL
ASD-LWS27A-24D18SM-RGBW-BK	24"	18	120-277	SMART APP	2,700 - 6,500 + RGBW	1,048	24" x 5-7/8" x 1-13/16"	2	ETL
ASD-LWS27A-48D36SM-RGBW-BK	48"	36	120-277	SMART APP	2,700 - 6,500 + RGBW	1,883	48" x 5-7/8" x 1-13/16"	1	ETL
ASD-LWS27A-72D40SM-RGBW-BK	72"	40	120-277	SMART APP	2,700 - 6,500 + RGBW	2,035	72" x 5-7/8" x 1-13/16"	1	ETL

LED OUTDOOR NARROW WALL SCONCE

ASD-LWS27N, ASD-LWS27N-RGBW

Model	Size	Watts	Input Voltage	Dimmable	CCT	Lm	Dimensions LxWxH	Pcs. per Carton	Certification
ASD-LWS27N-18D18BK	18"	18	120-277	Triac	3,000/4,000/5,000	1,548	18" x 3-1/8" x 2-1/4"	2	ETL
ASD-LWS27N-24D24BK	24"	24	120-277	Triac	3,000/4,000/5,000	2,061	24" x 3-1/8" x 2-1/4"	2	ETL
ASD-LWS27N-36D30BK	36"	30	120-277	Triac	3,000/4,000/5,000	2,534	36" x 3-1/8" x 2-1/4"	2	ETL
ASD-LWS27N-48D36BK	48"	36	120-277	Triac	3,000/4,000/5,000	2,886	48" x 3-1/8" x 2-1/4"	1	ETL
ASD-LWS27N-72D40BK	72"	40	120-277	Triac	3,000/4,000/5,000	3,245	72" x 3-1/8" x 2-1/4"	1	ETL

WITH RGBW

ASD-LWS27N-24D18SM-RGBW-BK	24"	18	120-277	SMART APP	2,700 - 6,500 + RGBW	960	24" x 3-1/8" x 2-1/4"	2	ETL
ASD-LWS27N-48D36SM-RGBW-BK	48"	36	120-277	SMART APP	2,700 - 6,500 + RGBW	1,979	48" x 3-1/8" x 2-1/4"	1	ETL

LED OUTDOOR WALL SCONCE WITH CENTER LIGHT

ASD-LWS27C, ASD-LWS27C-RGBW

Model	Size	Watts	Input Voltage	Dimmable	CCT	Lm	Dimensions LxWxH	Pcs. per Carton	Certification
ASD-LWS27C-18D18BK	18"	18	120-277	Triac	3,000/4,000/5,000	1,186	18" x 5-7/8" x 1-13/16"	2	ETL
ASD-LWS27C-24D24BK	24"	24	120-277	Triac	3,000/4,000/5,000	1,637	24" x 5-7/8" x 1-13/16"	2	ETL
ASD-LWS27C-36D30BK	36"	30	120-277	Triac	3,000/4,000/5,000	1,855	36" x 5-7/8" x 1-13/16"	2	ETL
ASD-LWS27C-48D36BK	48"	36	120-277	Triac	3,000/4,000/5,000	2,108	48" x 5-7/8" x 1-13/16"	1	ETL
ASD-LWS27C-72D40BK	72"	40	120-277	Triac	3,000/4,000/5,000	2,338	72" x 5-7/8" x 1-13/16"	1	ETL

WITH RGBW

ASD-LWS27C-18D20SM-RGBW-BK	18"	20	120-277	SMART APP	2,700 - 6,500 + RGBW	947	18" x 5-7/8" x 1-7/8"	2	ETL
ASD-LWS27C-24D24SM-RGBW-BK	24"	24	120-277	SMART APP	2,700 - 6,500 + RGBW	1,096	24" x 5-7/8" x 1-7/8"	2	ETL
ASD-LWS27C-48D36SM-RGBW-BK	48"	36	120-277	SMART APP	2,700 - 6,500 + RGBW	1,588	48" x 5-7/8" x 1-13/16"	1	ETL
ASD-LWS27C-72D40SM-RGBW-BK	72"	40	120-277	SMART APP	2,700 - 6,500 + RGBW	1,451	72" x 5-7/8" x 1-13/16"	1	ETL

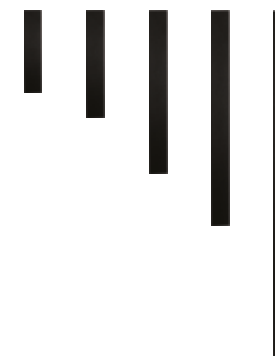

LED OUTDOOR BACKLIGHT WALL SCONCE

ASD-LWS27B

Model	Size	Watts	Input Voltage	Dimmable	CCT	Lm	Dimensions LxWxH	Pcs. per Carton	Certification
ASD-LWS27B-18D18BK	18"	18	120-277	Triac	3,000/4,000/5,000	1,272	18" x 3-1/8" x 2-1/4"	2	ETL
ASD-LWS27B-24D24BK	24"	24	120-277	Triac	3,000/4,000/5,000	1,605	24" x 3-1/8" x 2-1/4"	2	ETL
ASD-LWS27B-36D30BK	36"	30	120-277	Triac	3,000/4,000/5,000	1,945	36" x 3-1/8" x 2-1/4"	2	ETL
ASD-LWS27B-48D36BK	48"	36	120-277	Triac	3,000/4,000/5,000	2,280	48" x 3-1/8" x 2-1/4"	1	ETL
ASD-LWS27B-72D40BK	72"	40	120-277	Triac	3,000/4,000/5,000	2,469	72" x 3-1/8" x 2-1/4"	1	ETL

LED ROUND OUTDOOR WALL CYLINDER

ASD-LCLR, ASD-LCLR2-RGBW

Model	Light Direction	Watts	Input Voltage	Dimmable	CCT	Lm	Finish	Dimensions LxWxH	Pcs. per Carton	Certification
ASD-LCLR-1A-9BK	1	9	120	Triac	3,000/4,000/5,000	1,002	Black	4-3/8" x 6-7/16" x 7-7/8"	2	ETL
ASD-LCLR-2A-18BK	2	18	120	Triac	3,000/4,000/5,000	1,859	Black	4-3/8" x 6-7/16" x 11-13/16"	2	ETL

WITH PHOTOCELL

ASD-LCLR-1A-9BK-PC	1	9	120	No	3,000/4,000/5,000	1,002	Black	4-3/8" x 6-7/16" x 7-7/8"	2	ETL
ASD-LCLR-2A-18BK-PC	2	18	120	No	3,000/4,000/5,000	1,859	Black	4-3/8" x 6-7/16" x 11-13/16"	2	ETL

WITH BATTERY BACK-UP

ASD-LCLR-MV-2A-18BK-EM	2	18	120-277	No	3,000/4,000/5,000	1,676	Black	4-5/16" x 6-9/16" x 11-13/16"	6	ETL
------------------------	---	----	---------	----	-------------------	-------	-------	-------------------------------	---	-----

WITH DECORATIVE RINGS

ASD-LCLR-1B-9BK	1	9	120-277	Triac	3,000/4,000/5,000	579	Black	4-3/8" x 6-9/16" x 7-15/16"	2	ETL
ASD-LCLR-2B-18BK	2	18	120-277	Triac	3,000/4,000/5,000	1,180	Black	4-3/8" x 6-9/16" x 11-13/16"	2	ETL

WITH RGBW

ASD-LCLR2-30SM-RGBW-BK	2	30	120	SMART APP	2,700 - 6,500 + RGBW	919	Black	4-15/16" x 6-1/16" x 12-1/18"	2	ETL
------------------------	---	----	-----	-----------	----------------------	-----	-------	-------------------------------	---	-----



LED SQUARE OUTDOOR WALL CYLINDER

ASD-LCLS

Model	Light Direction	Watts	Input Voltage	Dimmable	CCT	Lm	Finish	Dimensions LxWxH	Pcs. per Carton	Certification
ASD-LCLS-1A-9BK	1	9	120-277	Triac	3,000/4,000/5,000	819	Black	4-3/8" x 5-13/16" x 7-7/8"	6	ETL
ASD-LCLS-2A-18BK	2	18	120-277	Triac	3,000/4,000/5,000	1,613	Black	4-3/8" x 5-13/16" x 10-3/16"	6	ETL

WITH PHOTOCELL

ASD-LCLS-1A-9BK-PC	1	9	120-277	No	3,000/4,000/5,000	738	Black	4-3/8" x 5-13/16" x 7-7/8"	6	ETL
ASD-LCLS-2A-18BK-PC	2	18	120-277	No	3,000/4,000/5,000	1,541	Black	4-3/8" x 5-13/16" x 10-3/16"	6	ETL

WITH DECORATIVE RINGS

ASD-LCLS-1B-9BK	1	9	120-277	Triac	3,000/4,000/5,000	502	Black	4-3/8" x 5-13/16" x 7-15/16"	2	ETL
ASD-LCLS-2B-18BK	2	18	120-277	Triac	3,000/4,000/5,000	962	Black	4-3/8" x 5-13/16" x 11-13/16"	2	ETL





BULB ROUND OUTDOOR WALL CYLINDER

ASD-OCLR

Model	Light Direction	Bulb Type	Voltage	Finish	Dimensions LxWxH	Pcs. per Carton	Certification
ASD-OCLR-1A-BK	1	1 x E26 60W max	120	Black	4-3/8" x 6-7/16" x 7-7/8"	2	ETL
ASD-OCLR-1A-SS	1	1 x E26 60W max	120	Stainless Steel	4-3/8" x 6-9/16" x 7-7/8"	6	ETL
ASD-OCLR-1A-WH	1	1 x E26 60W max	120	White	4-3/8" x 6-7/16" x 7-7/8"	2	ETL
ASD-OCLR-2A-BK	2	2 x E26 60W max	120	Black	4-3/8" x 6-7/16" x 11-13/16"	2	ETL
ASD-OCLR-2A-SS	2	2 x E26 60W max	120	Stainless Steel	4-3/8" x 6-9/16" x 11-13/16"	6	ETL
ASD-OCLR-2A-WH	2	2 x E26 60W max	120	White	4-3/8" x 6-7/16" x 11-13/16"	2	ETL

WITH PHOTOCELL

ASD-OCLR-1A-PC-BK	1	1 x E26 60W max	120	Black	4-3/8" x 6-7/16" x 7-7/8"	2	ETL
ASD-OCLR-2A-PC-BK	2	2 x E26 40W max	120	Black	4-3/8" x 6-7/16" x 11-13/16"	2	ETL

WITH DECORATIVE RINGS

ASD-OCLR-1B-BK	1	1 x E26 60W max	120	Black	4-3/8" x 6-9/16" x 7-15/16"	2	ETL
ASD-OCLR-2B-BK	2	2 x E26 60W max	120	Black	4-3/8" x 6-9/16" x 11-13/16"	2	ETL



BULB SQUARE OUTDOOR WALL CYLINDER

ASD-OCLS

Model	Light Direction	Bulb Type	Voltage	Finish	Dimensions LxWxH	Pcs. per Carton	Certification
ASD-OCLS-1A-BK	1	1 x E26 60W max	120	Black	4-3/8" x 5-13/16" x 7-7/8"	2	ETL
ASD-OCLS-2A-BK	2	2 x E26 60W max	120	Black	4-3/8" x 5-13/16" x 11-13/16"	2	ETL

WITH PHOTOCELL

ASD-OCLS-1A-PC-BK	1	1 x E26 60W max	120	Black	4-3/8" x 5-13/16" x 7-7/8"	2	ETL
ASD-OCLS-2A-PC-BK	2	2 x E26 40W max	120	Black	4-3/8" x 5-13/16" x 11-13/16"	2	ETL

WITH DECORATIVE RINGS

ASD-OCLS-1B-BK	1	1 x E26 60W max	120	Black	4-3/8" x 5-13/16" x 7-15/16"	2	ETL
ASD-OCLS-2B-BK	2	2 x E26 60W max	120	Black	4-3/8" x 5-13/16" x 11-13/16"	2	ETL



BULB ROUND OUTDOOR BOLLARD WITH DECORATIVE RING

ASD-BLC-R

Model	Size	Bulb Type	Voltage	Finish	Dimensions LxWxH	Pcs. per Carton	Certification
ASD-BLC-R12B-BK	12'	1 x E26 60W max	120	Black	11-13/16" x 5-1/2" x 5-1/2"	1	ETL
ASD-BLC-R24B-BK	24'	1 x E26 60W max	120	Black	23-5/8" x 5-1/2" x 5-1/2"	1	ETL



BULB SQUARE OUTDOOR BOLLARD WITH DECORATIVE RING

ASD-BLC-S

Model	Size	Bulb Type	Voltage	Finish	Dimensions LxWxH	Pcs. per Carton	Certification
ASD-BLC-S12B-BK	12'	1 x E26 60W max	120	Black	11-13/16" x 4-3/4" x 4-3/4"	1	ETL
ASD-BLC-S24B-BK	24'	1 x E26 60W max	120	Black	23-5/8" x 4-3/4" x 4-3/4"	1	ETL