

Emergency Light, MR16 Heads Light

FEATURES:

- Dual-voltage input 120V/277V
- Maintenance-free sealed lead-acid battery
- Injection molded, high-impact, UV stabilized, UL94 V-O thermoplastic construction in white or black finish
- Universal J-box pattern knockout
- Universal mounting plate with quick-connect feature
- Fully adjustable glare-free lamp head
- Two Factory installed LED lamp heads
- Provided with a waterproof shield for use in wet locations
- Temperature rating:
-20° to 50°C (-4° to 122°F)

CERTIFICATIONS:

- UL924 Listed for Wet Locations

WARRANTY:

5 years. Check maxlite.com/warranties for details.



EMERGENCY LIGHT WET LOCATION RATED

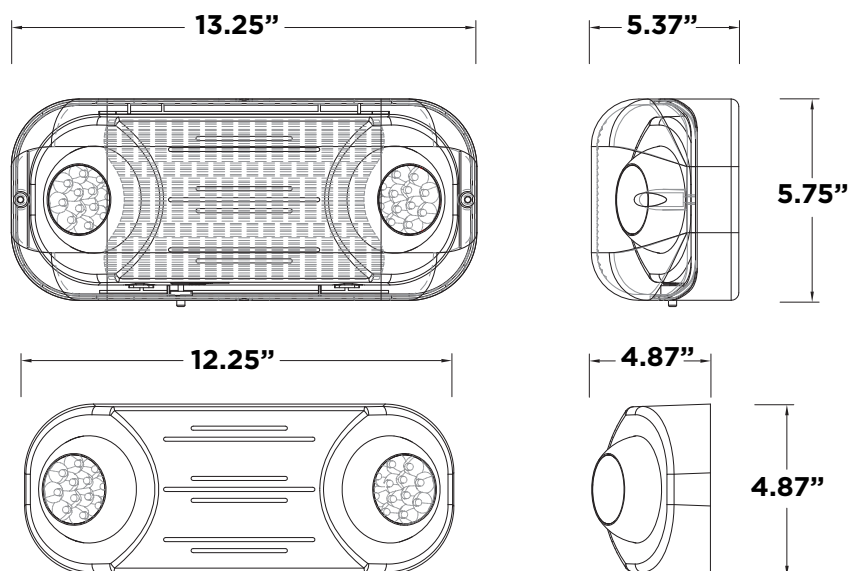

ORDERING INFORMATION:

IMAGE	ORDER CODE	MODEL	DESCRIPTION	UPC
	109732	EML-2HMW-WL2	Emergency Light LED, 2 MR16 Heads, White, 120V or 277V, Battery Backup -20°C, Wet Locations, 58 lumen per head, 1.9W (120/277V) draw	767627044243

Emergency Light, MR16 Heads Light

EMERGENCY LIGHT WET LOCATION ORDERING:

PRODUCT IMAGE	ORDER NUMBER	MODEL	DESCRIPTION	PERFORMANCE
	109731	EML-2HMW-WL	Emergency Light LED, 2 MR16 Heads, White, 120v Or 277v, Battery Backup, Wet Locations	58 lumen per head, 1.9W (120/277V) draw
	109732	EML-2HMW-WL2	Emergency Light LED, 2 MR16 Heads, White, 120v Or 277v, Battery Backup -20°C, Wet Locations	58 lumen per head, 1.9W (120/277V) draw
	109733	EML-2HWHC-WL	Emergency Light LED, 2 Heads, White, High Capacity, High Lumen Output, Battery Backup, Wet Locations	78 lumens per head, 4.4/4.5W (120/277V) draw
	109734	EML-2HWHCRC-WL	Emergency Light LED, 2 Heads, White, High Capacity, Remote Capable Up To 6 Heads, Battery Backup, Wet Locations	78 lumens per head, 4.4/4.5W (120/277V) draw, up to 12 additional remote heads

REMOTE HEADS LIGHT WET LOCATION ORDERING:



PRODUCT IMAGE	ORDER NUMBER	MODEL	DESCRIPTION	PERFORMANCE
	109735	ERO-SWHC	Emergency Remote Head, Outdoor (WL), Single, White, High Capacity Only	72 lumens, 3.6V, 1.17W, WL listed
	109736	ERO-2HWHC	Emergency Remote Head, Outdoor (WL), Double, White, High Capacity Only	72 lumens - per head, 3.6V, 1.17W - per head, WL listed

EMERGENCY SIGNS WET LOCATION ORDERING







PRODUCT IMAGE	ORDER NUMBER	MODEL	DESCRIPTION	PERFORMANCE
	109737	EX-GW-WL	Exit, Thermoplastic, Green Letters, White, Battery Backup, Wet Locations	-
	109738	EX-GWRC-WL	Exit, Thermoplastic, Green Letters, White, Battery Backup, Remote Capable Up To 2 Heads, Wet Locations	-
	109739	EX-GW-WL2	Exit, Thermoplastic, Green Letters, White, Battery Backup -20°C, Wet Locations	-
	109740	EX-RW-WL	Exit, Thermoplastic, Red Letters, White, Battery Backup, Wet Locations	-
	109741	EX-RWRC-WL	Exit, Thermoplastic, Red Letters, White, Battery Backup, Remote Capable Up To 2 Heads, Wet Locations	-
	109742	EX-RW-WL2	Exit, Thermoplastic, Red Letters, White, Battery Backup -20°C, Wet Locations	-
	109743	EXC-GW-WL	Exit Emergency Combo, Thermoplastic, Green Letters, White, Battery Backup, Wet Locations	63 lumen per head, 3.08W (120/277V) draw
	109744	EXC-GWRC-WL	Exit Emergency Combo, Thermoplastic, Green Letters, White, Battery Backup, Remote Capable Up To 2 Heads, Wet Locations	63 lumen per head, 3.08W (120/277V) draw
	109745	EXC-RW-WL	Exit Emergency Combo, Thermoplastic, Red Letters, White, Battery Backup, Wet Locations	63 lumen per head, 1.89W (120/277V) draw
	109746	EXC-RWRC-WL	Exit Emergency Combo, Thermoplastic, Red Letters, White, Battery Backup, Remote Capable Up To 2 Heads, Wet Locations	63 lumen per head, 1.89W (120/277V) draw
	109747	EXC-RW-WL2	Exit Emergency Combo, Thermoplastic, Red Letters, White, Battery Backup -20°C, Wet Locations	63 lumen per head, 1.89W (120/277V) draw

Emergency Light, MR16 Heads Light

REMOTE HEAD COMPATABILITY:

EMERGENCY LIGHTS # OF REMOTE HEADS SUPPORTED	
 EML-2HWHCRC-WL	
 ERO-SWHC	12
 ERO-2HWHC	6

REMOTE HEAD COMPATABILITY:

EXIT LIGHTS # OF REMOTE HEADS SUPPORTED																			
 EX-GWRC-WL					 EX-RWRC-WL					 EXC-GWRC-WL					 EXC-RWRC-WL				
 ERO-SW	2	2	2	2															
 ERO-2HW	1	1	1	1															