



eran group.

THE TRUE FACE OF LIGHTING



INDOOR & OUTDOOR
LIGHTING



LANDSCAPE LIGHTING



CEILING FANS

ALTITUDE

2025

CATALOG

Table of Contents



1

About Eran Group

2

Our Story

3

Eran Is Building In America!

5

MEDINAH POWER

10

Indoor Lighting

36

Discs & Downlights

52

Exit & Emergency Lighting

68

Exterior Security Lights & Poles

104

Solar Lighting

118

TERRA Landscape Lighting

132

ALTITUDE Ceiling Fans

About Eran Group



From Humble Beginnings to a True Global Operations network

Welcome to Eran Group, where we are dedicated to revolutionizing the world of lights, fans, and electrical goods. With a fresh perspective and innovative strategies, we are here to make these essential products so much better. Get ready to experience a new era of lighting solutions.

We believe that innovation is the key to progress. Our team of experts is constantly pushing the boundaries of lighting technology to bring you products that are not only energy-efficient but also aesthetically pleasing. With our commitment to quality and design, we are redefining lighting standards and creating products that enhance your spaces like never before.

Eran Group and its own specialized developed brands offer a wide range of products and services to meet our customers needs in a variety of industries.

For more than three decades, Eran has grown from a component manufacturer specializing in lenses, refractors, and globes for the lighting industry to a global operations network tailoring products, engineering, design and logistics solutions to the needs of original equipment manufacturer customers around the world.

Today, our extraordinary innovation, design and manufacturing capabilities makes us the preferred partner for our customers.

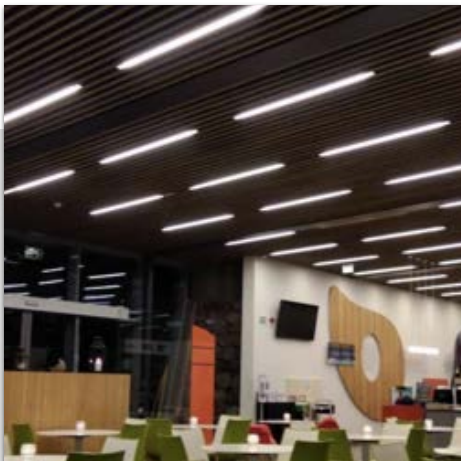

1988

Our roots date back to 1988. Eran Plastics out of Newburgh, New York, specializing in injection molded plastic components and globes, focused on serving USA and Canadian lighting OEMs.

2000

Eran Industrial expanded its operations into Asia, serving 4 out of the 5 largest lighting OEMs and the majority of lighting manufacturers and top brands in North America.

2025

Fast forward to today, Eran Industrial is based out of Boca Raton, FL with a full in-house product design & engineering team and a 760,000 square foot facility right outside Mobile, Alabama which serves as Eran's main manufacturing & distribution facility.

Eran is building in America!



Eran acquired a 760,000 square foot industrial facility outside of Mobile, Alabama in June 2022, that has been revolutionizing the way we deliver value and cater to our customers' needs. Situated just 26 miles from Mobile's port, our facility enjoys prime positioning for efficient logistics and seamless transportation.

Made in America: At Eran, we take immense pride in being able to offer Made in America products. With our new facility, we can further enhance our products and diversify our SKU range, all while utilizing the same work-in-progress inventory. This achievement is a resounding victory for our valued customer base, who appreciate the quality and reliability that comes with American manufacturing.

Expansion and Adaptability: The scale of our facility opens up new horizons for Eran. With ample space and resources, we are poised to expand into various manufacturing disciplines based on the evolving needs of our customers. By prioritizing their requirements, we can stay ahead of the curve and deliver innovative solutions that drive success for both Eran and our valued partners.

SWEET HOME



Alabama

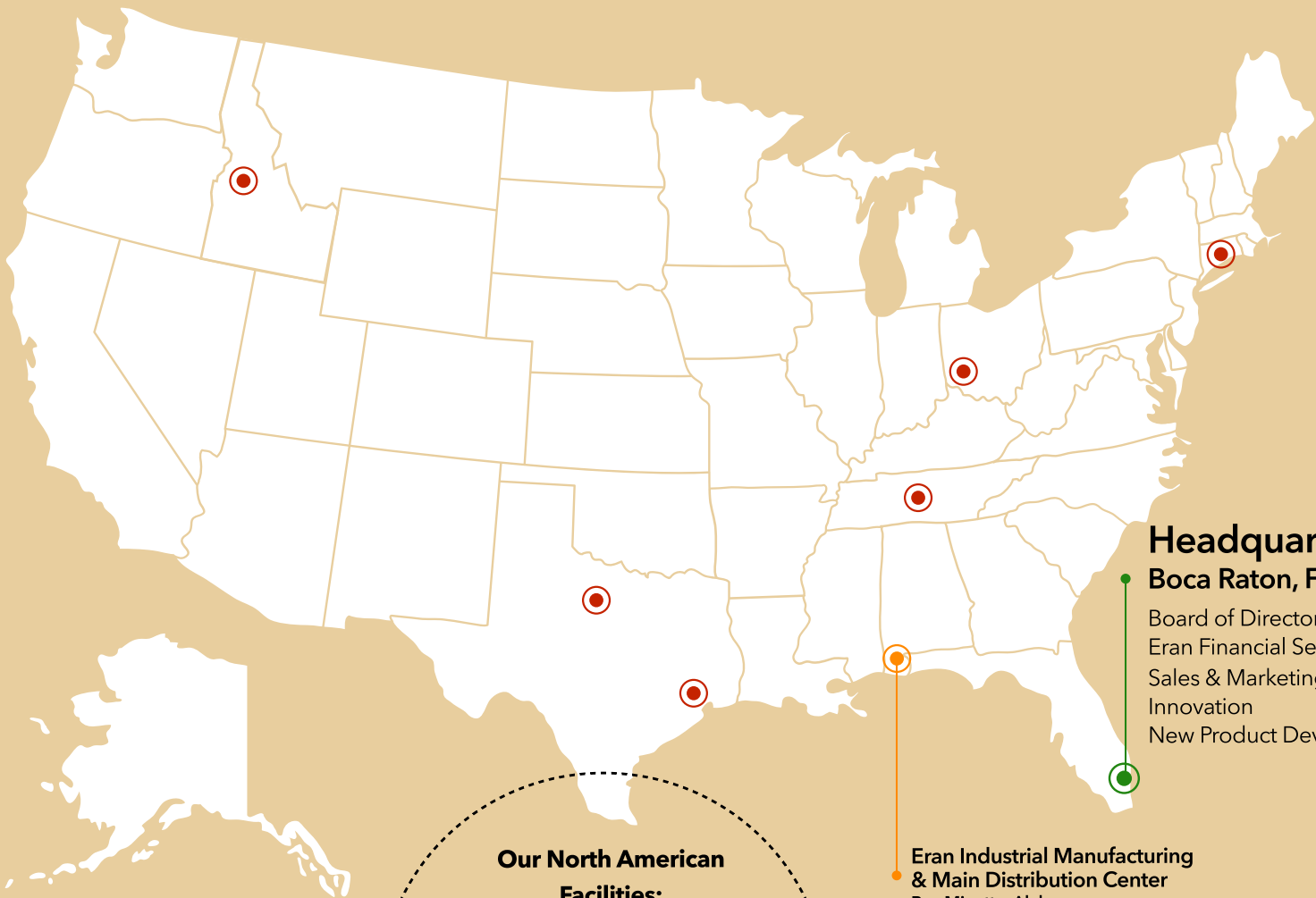

**Headquarters
Boca Raton, FL**

Board of Directors
Eran Financial Services
Sales & Marketing Dept.
Innovation
New Product Development

**Eran Industrial Manufacturing
& Main Distribution Center**
Bay Minette, Alabama

**Our North American
Facilities:**

- Bay Minette, AL
- Cincinnati, OH
- Houston, TX
- Dallas/Fort Worth, TX
- South Windsor, CT
- La Vergne, TN
- North West (coming soon)



MEDINAH POWER

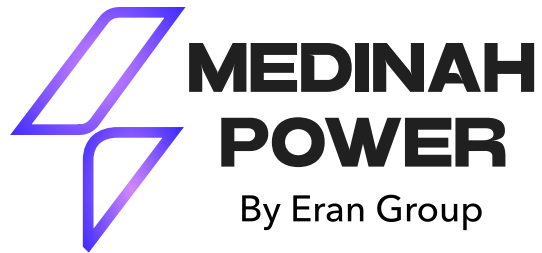

The True Face of Lighting

Step into a new era of dependability with Medinah Power, where we redefine the industry standards and empower distributors across the USA. Say goodbye to the industry's exorbitant markups and embrace a new wave of affordability and excellence. At Medinah Power, we are driven by a mission to ignite the electrical distributor through remarkable lighting solutions. Our products are crafted with a perfect blend of inspired design, cutting-edge technology, and the unmatched power of American ingenuity.

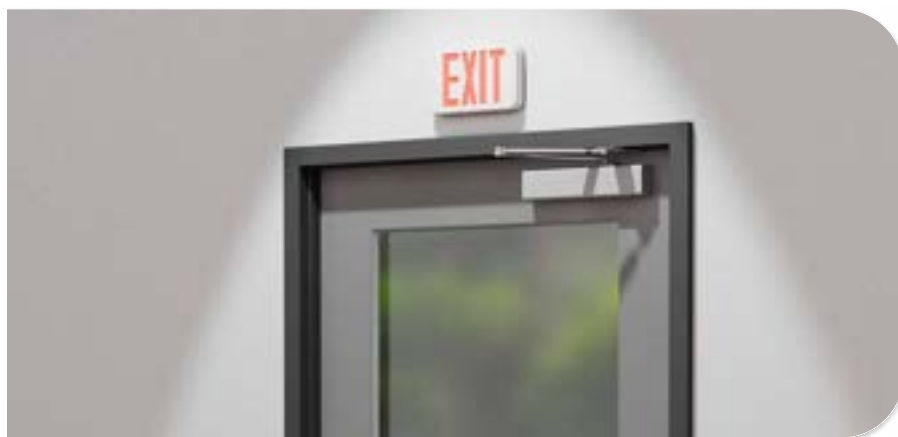

Why Medinah Power

We are here to make your experience absolutely hassle free



No nonsense Pricing

The easiest way to purchase, You pay what you see.



Easy Stocking Programs

Triple P brings you a ZERO risk player - always wins stocking program.



Hassle-Free Returns

Ship it back and we take it! That easy! Hassle free returns.



On-Demand Customer Service

Full-service team ready to help with strong support!

Preferred Partner Program (PPP)

Our Preferred Partners who stock three or more product families will get access to Medinah's lowest pricing tier for any order size.



Always in stock commitment.



Incredible extended payment terms.



Free custom showroom display.



Buy only what you need, No overstock!

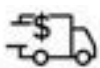

\$1,000 pre-paid freight vs our standard \$2,500.

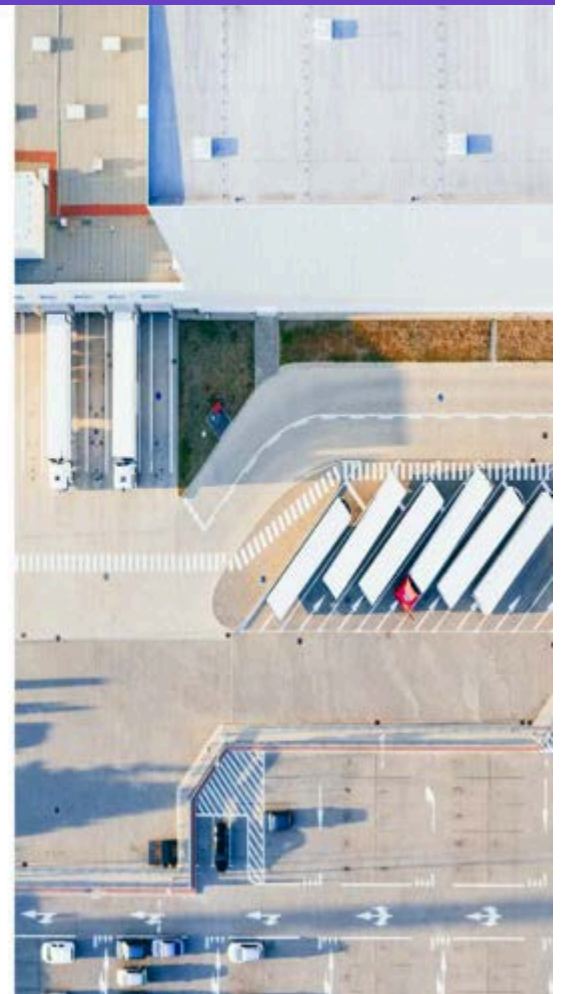

Medinah Store Displays

Free for Medinah PPP Members



Meet **MEDINAH PAYS**



The best distributor cash rewards program in the market.



Inquire today for all the exciting details about our Medinah Pays rewards program.



INDOOR
LIGHTING

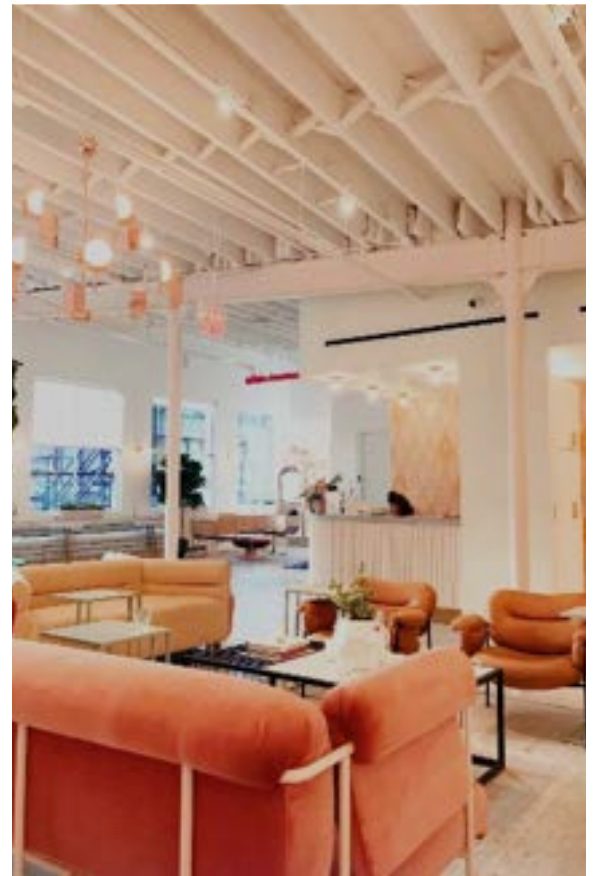
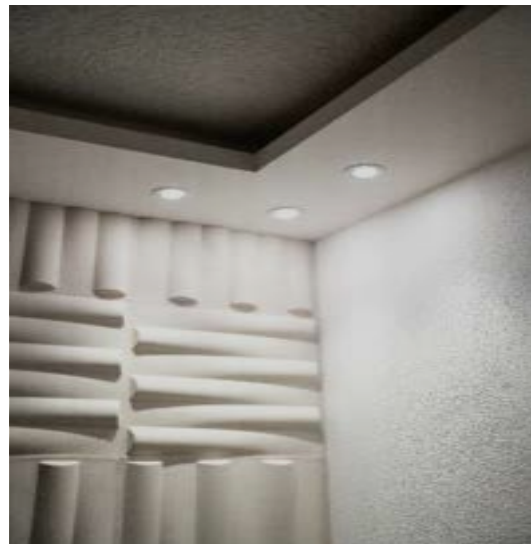
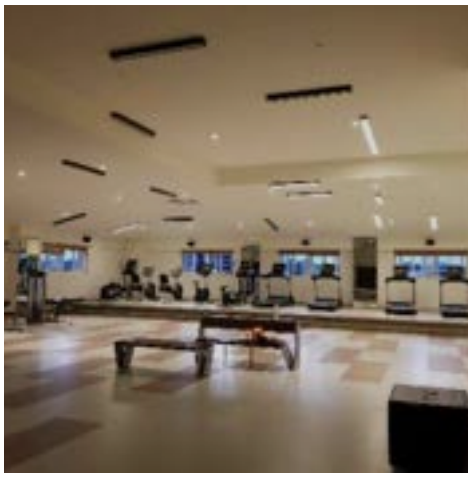





INDOOR LIGHTING

LED STRIP LIGHTS

STR Series

Versatile lighting made easy



-  Easy Install
-  0-10V Dimming
-  120-277V
-  Lumen & Watt Selectable
-  White Color Selectable



Product Features

Light Output: 1,950 - 10,400 Lumens

Wattage: 15 - 80 Watts

Replaces: Up to 175W Fluorescent

Efficacy: Up to 130 LPW

CCT Selectable: 3500K/4000K/5000K/5700K/6500K

CRI Options: 80 CRI

Finish Color: White

Mounting: Surface Mount, Suspension Mount



Performance Specification

Model No.	Power (W)	Lumens (lm)	CCT (K)	LPW	Input Voltage	Finish
2 FT STR2-15T25W-5CCT-DV2	15W 20W 25W	1,950 2,600 3,250	35K/40K/50K/57K/65K	130	120-277V	White
4 FT STR4-20T40W-5CCT-DV2	25W 30W 40W	3,250 3,900 5,200	35K/40K/50K/57K/65K	130	120-277V	White
8 FT STR8-50T80W-5CCT-DV2	50W 64W 80W	6,500 8,320 10,400	35K/40K/50K/57K/65K	130	120-277V	White

Note: Contact for custom configuration & specifications

Product Dimensions

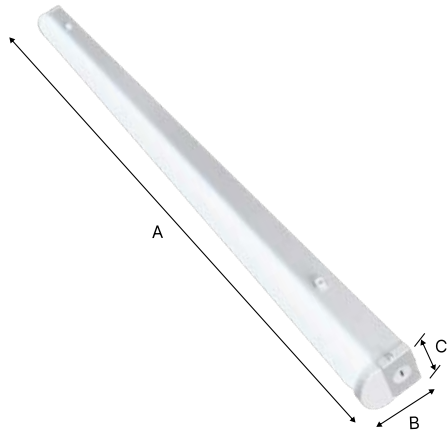

	STR2-15T25W-5CCT-DV2
A	23.9 in
B	2.0 in
C	2.5 in

	STR4-20T40W-5CCT-DV2
A	48.3 in
B	2.0 in
C	2.5 in

	STR8-50T80W-5CCT-DV2
A	95.9 in
B	2.0 in
C	2.5 in

Packaging Dimensions

Catalog Number	Master Pack	Dimensions
STR2-15T25W-5CCT-DV2	12	25.00 x 11.34 x 9.84 in / 21.6lbs
STR4-20T40W-5CCT-DV2	12	49.00 x 11.34 x 9.84 in / 36.2lbs
STR8-50T80W-5CCT-DV2	6	97.00 x 8.58 x 6.77 in / 42.1lbs

Photometric Specification

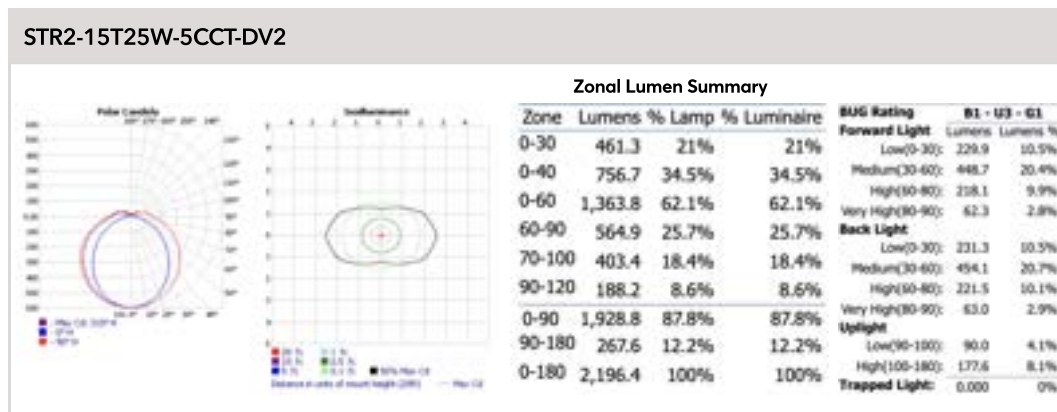

Note: Additional photometry available on request.

Accessories

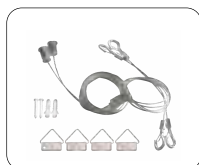

Suspension Cables
DP-PKT-12-S



Connecting Kit
STR-SPM-CA

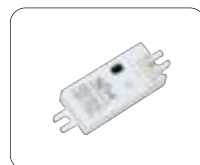

Microwave Motion
Sensor
STR-MS



Sensor Remote
STR-RC

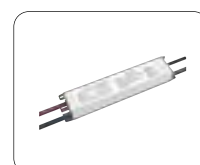

8W EM
Battery Backup
STR-EM

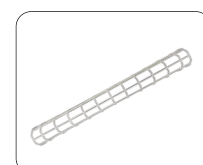

Wire Guards
STR2-WG
STR4-WG

RETROFIT LED STRIP LIGHT

RSTR Series

Versatile lighting made easy



- Easy Install
- 0-10V Dimming
- 120-277V
- Lumen & Watt Selectable
- White Color Selectable

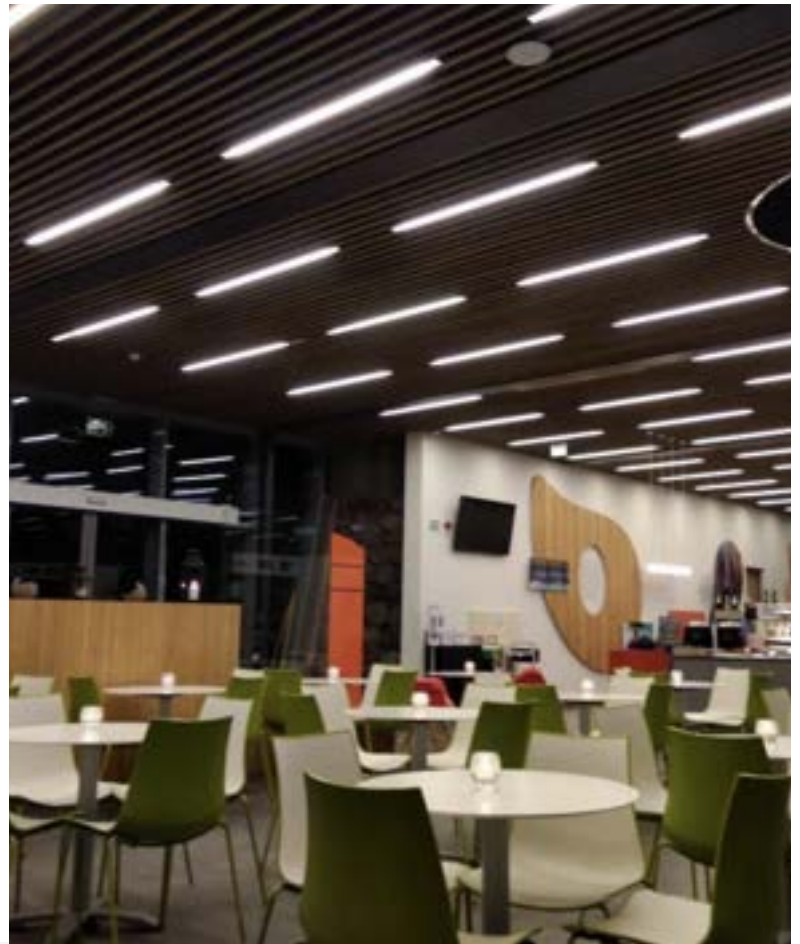

Product Features

Light Output: 2,600 - 5,200 Lumens

Wattage: 20 - 40 Watts

Replaces: Up to 175W Fluorescent

Efficacy: Up to 130LPW

CCT Selectable: 3500K/4000K/5000K

CRI Options: 80 CRI

Finish Color: White

Mounting: Surface Mount, Retrofit Mount, Suspension Mount



Performance Specification

Model No.	Power (W)	Lumens (lm)	CCT (K)	LPW	Input Voltage	Finish
4 FT RSTR4-20T40W-3CCT-DV2	20W	2,600	3500K	130	120-277V	White
	30W	3,900	4000K			
	40W	5,200	5000K			

Note: Contact for custom configuration & specifications

Product Dimensions

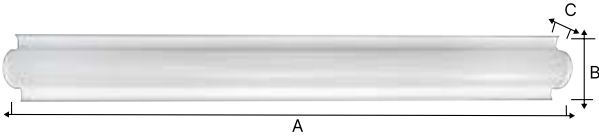

RSTR4-20T40W-3CCT-DV2	
A	47.9 in
B	5.9 in
C	2.9 in

Packaging Dimensions

Catalog Number	Master Pack Quantity	Dimensions
RSTR4-20T40W-3CCT-DV2	2	49.8 in x 7.4 in x 6.2 in / 13.2lbs

Photometric Specification

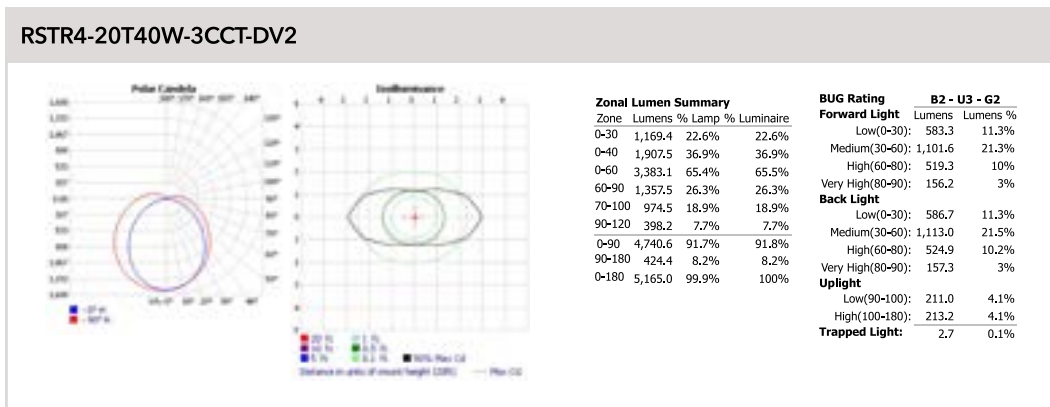





Note: Additional photometry available on request.

BACKLIT LED FLAT PANELS

DPS Series - 3 CCT Selectable

With Smart Capability



-  Easy Install
-  0-10V Dimming
-  120-277V
-  Lumen & Watt Selectable
-  White Color Selectable

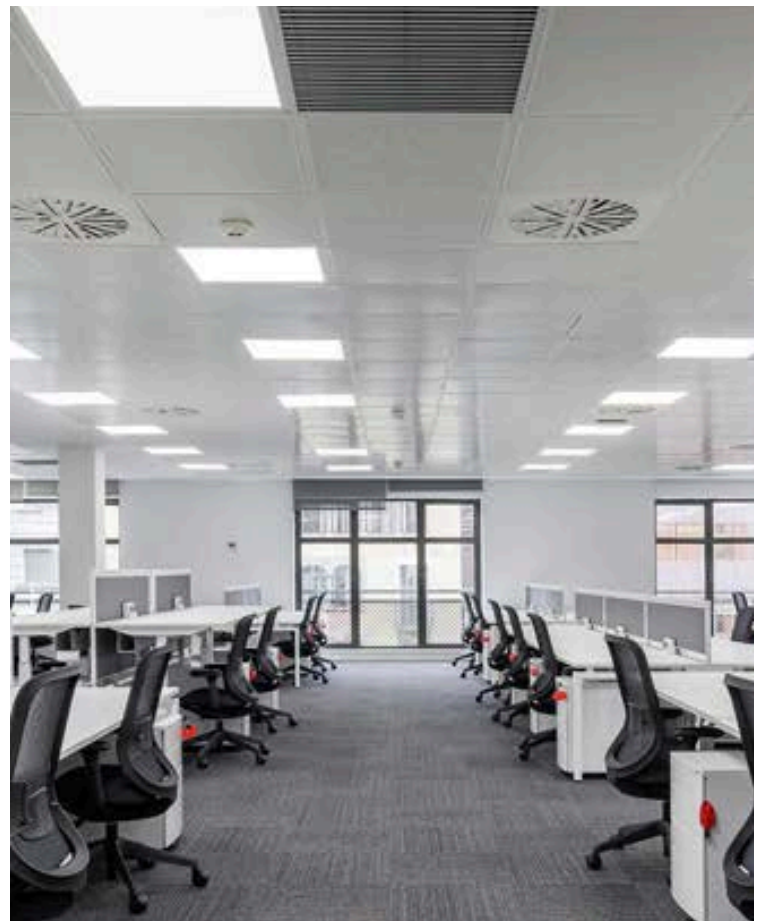

Product Features

Light Output: 2,500 - 5,000 Lumens

Wattage: 20 - 40 Watts

Replaces: Up to 175W Fluorescent

Efficacy: Up to 125LPW

CCT Selectable: 3500K/4000K/5000K

CRI Options: 80 CRI

Finish Color: White

Mounting: Recessed, Surface Mount, Suspension Mount

12V Aux ready frame for plug & play motion sensors:



Performance Specification

Model No.	Power (W)	Lumens (lm)	CCT (K)	LPW	Input Voltage	Finish
1 x 4 FT DPS-14-U-P-ET-4 DPS-14-U-P-S-ET-4**	20W	2,500	3500K	125	120-277V	White
	25W	3,125	4000K			
	30W	3,750	5000K			
2 x 4 FT DPS-24-U-P-S-ET-4**	30W	3,750	3500K	125	120-277V	White
	35W	4,375	4000K			
	40W	5,000	5000K			

** 12V Aux Driver and snap in ready frame for smart motion sensor.

Note: Contact for custom configuration & specifications

Product Dimensions



	DPS-14-U-P-ET-4 / DPS-14-U-P-S-ET-4*
A	47.8 in
B	11.9 in
C	1.5 in

	DPS-24-U-P / DPS-24-U-P-S-ET-4*
A	47.3 in
B	23.7 in
C	1.5 in

Packaging Dimensions

Catalog Number	Master Pack Quantity	Dimensions
DPS-14-U-P-ET-4 / DPS-14-U-P-S-ET-4*	4	49.3 x 13.8 x 6.2 in / 22.5lbs
DPS-24-U-P-S-ET-4*	4	49.3 x 25.6 x 6.2 in / 37.7lbs

Photometric Specification

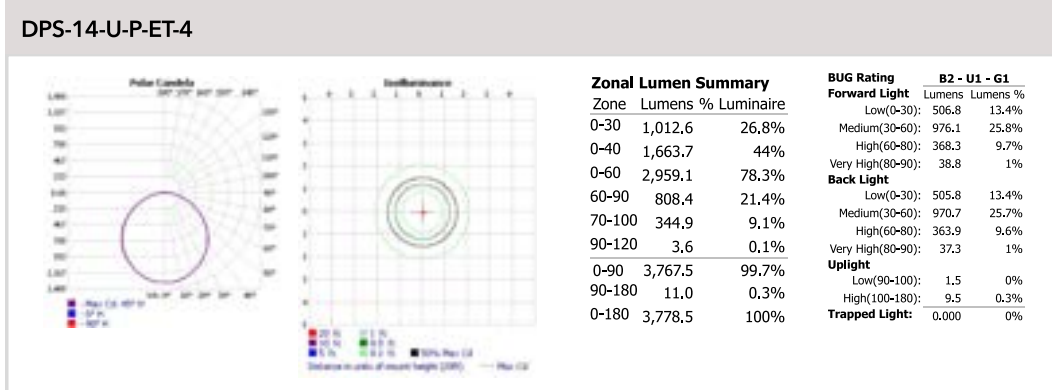

Note: Additional photometry available on request.

Accessories



Surface Mount Kit
DP-SMF-24-W
DP-SMF-22-W
DP-SMF-14-W

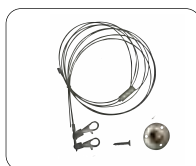





Cable Kit
DP-SMK-12-S
DP-SMK-14-S

BACKLIT LED FLAT PANELS

DPS Series - 5 CCT Selectable

A perfect blend of
efficiency & value



-  Easy Install
-  0-10V Dimming
-  120-277V
-  Lumen & Watt Selectable
-  White Color Selectable



Product Features

Light Output: 2,250 - 6,250 Lumens

Wattage: 18 - 50 Watts

Replaces: Up to 175W Fluorescent

Efficacy: Up to 125LPW

CCT Selectable: 30K/35K/40K/50K/65K

CRI Options: 80 CRI

Finish Color: White

Mounting: Recessed, Surface Mount,
Suspension Mount



Performance Specification

Model No.	Power (W)	Lumens (lm)	CCT (K)	LPW	Input Voltage	Finish
2 x 2 FT DPS-22-U-P-30-5CCT	18W	2,250	30K/35K/40K/50K/65K	125	120-277V	White
	24W	3,000				
	30W	3,750				
2 x 4 FT DPS-24-U-P-50-5CCT	30W	3,750	30K/35K/40K/50K/65K	125	120-277V	White
	40W	5,000				
	50W	6,250				

Note: Contact for custom configuration & specifications

Product Dimensions



DPS-22-U-P-30-5CCT		DPS-24-U-P-50-5CCT	
A	23.7 in	A	47.8 in
B	23.7 in	B	23.7 in
C	1.3 in	C	1.3 in

Packaging Dimensions

Catalog Number	Master Pack Quantity	Dimensions
DPS-22-U-P-30-5CCT	4	25.2 x 25.2 x 5.9 in / 19.0lbs
DPS-24-U-P-50-5CCT	4	49.1 x 25.2 x 5.9 in / 37.7lbs

Photometric Specification

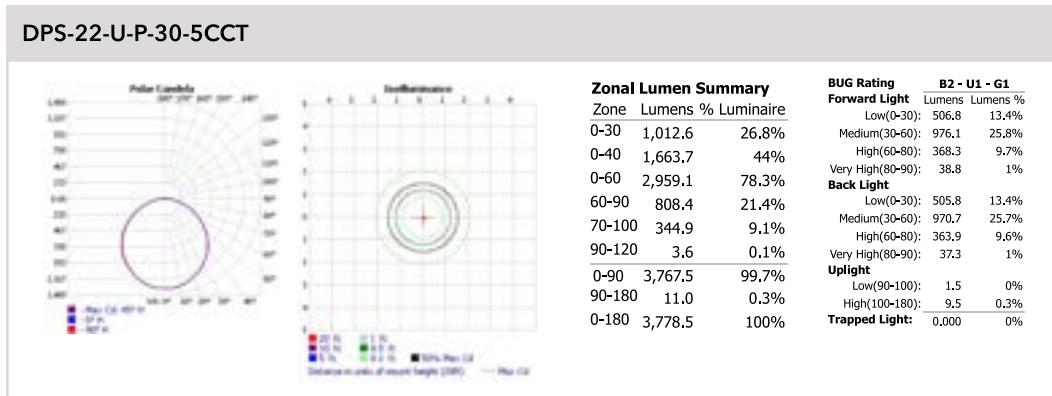

Note: Additional photometry available on request.

Accessories



Surface Mount Kit
DP-SMF-24-W
DP-SMF-22-W



Cable Kit
DP-SMK-12-S
DP-SMK-14-S

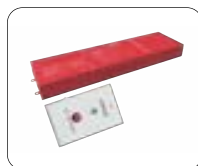





EM Battery Backup
DP-EM

BACKLIT LED FLAT PANELS

DPS Series - 5 Wattage & 5 CCT Selectable

A perfect blend of
efficiency & value



-  Easy Install
-  0-10V Dimming
-  120-277V
-  Lumen & Watt Selectable
-  White Color Selectable

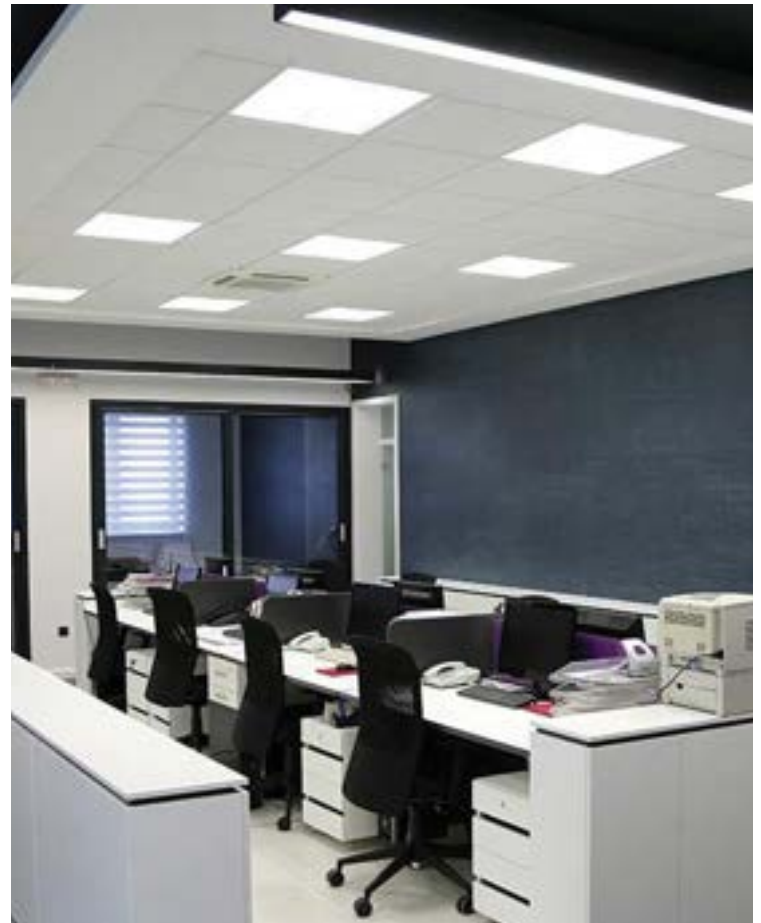

Product Features

Light Output: 1,875 - 6,250 Lumens

Wattage: 15 - 50 Watts

Replaces: Up to 175W Fluorescent

Efficacy: Up to 125LPW

CCT Selectable: 30K/35K/40K/50K/65K

CRI Options: 80 CRI

Finish Color: White

Mounting: Recessed, Surface Mount,
Suspension Mount



Performance Specification

Model No.	Power (W)	Lumens (lm)	CCT (K)	LPW	Input Voltage	Finish
1 x 4 FT DPS-14-U-P-15T35-5CCT	15/20/25/30/35W	1875 / 2500 / 3125 / 3750 / 4375	30K/35K/40K/50K/65K	125	120-277V	White
2 x 2 FT DPS-22-U-P-15T35-5CCT	15/20/25/30/35W	1875 / 2500 / 3125 / 3750 / 4375	30K/35K/40K/50K/65K	125	120-277V	White
2 x 4 FT DPS-24-U-P-20T50-5CCT	20/25/30/40/50W	2500 / 3125 / 3750 / 5000 / 6250	30K/35K/40K/50K/65K	125	120-277V	White

Note: Contact for custom configuration & specifications

Product Dimensions



	DPS-14-U-P-15T35
A	47.8 in
B	11.9 in
C	1.2 in

	DPS-22-U-P-15T35
A	23.7 in
B	23.7 in
C	1.2 in

	DPS-24-U-P-20T50
A	47.7 in
B	23.7 in
C	1.2 in

Packaging Dimensions

Catalog Number	Master Pack Quantity	Dimensions
DPS-14-U-P-15T35-5CCT	4	49.0 x 13.5 x 5.4 in / 20.9lbs
DPS-22-U-P-15T35-5CCT	4	25.1 x 25.4 x 5.4 in / 21.2lbs
DPS-24-U-P-20T50-5CCT	4	49.0 x 25.4 x 5.4 in / 38.2lbs

Photometric Specification

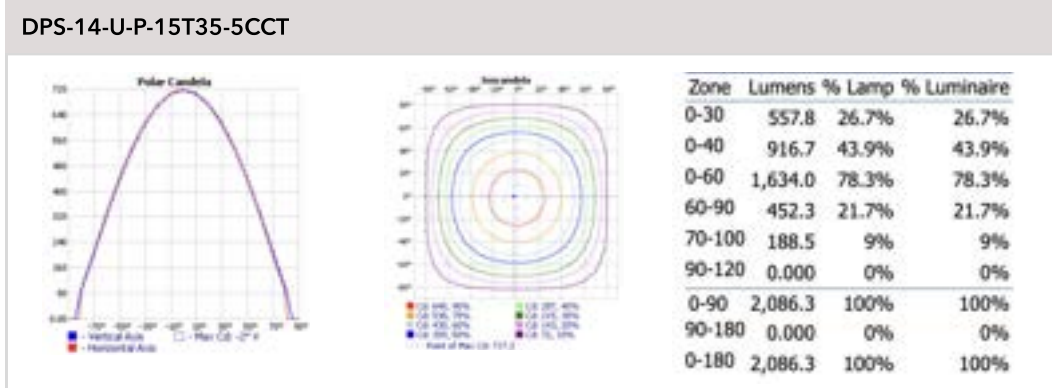

Note: Additional photometry available on request.

Accessories



Surface Mount Kit
 DP-SMF-24-W
 DP-SMF-22-W
 DP-SMF-14-W



Cable Kit
 DP-SMK-12-S
 DP-SMK-14-S



EM Battery Backup
 DPS-EL

LED TROFFERS

TRO Series - 5 Wattage & 5 CCT Selectable

Light Up Your Environment: Modern Volumetric Troffer Solutions.



- Easy Install
- 0-10V Dimming
- 120-277V
- Lumen & Watt Selectable
- White Color Selectable



Product Features

Light Output: 2,500 - 6,200 Lumens

Wattage: 20 - 50 Watts

Replaces: Up to 175W Fluorescent

Efficacy: Up to 125LPW

CCT Selectable: 30K/35K/40K/50K/65K

CRI Options: 80 CRI

Finish Color: White

Mounting: Recessed



Performance Specification

Model No.	Power (W)	Lumens (lm)	CCT (K)	LPW	Input Voltage	Finish
2 x 2 FT TRO2-20T40-5CCT-DV2-WH	20/25/30/35/40W	2500 / 3125 / 3750 / 4375 / 5000	30K/35K/40K/50K/65K	125	120-277V	White
2 x 4 FT TRO4-20T50-5CCT-DV2-WH	20/25/30/40/50W	2500 / 3125 / 3750 / 5000 / 6200	30K/35K/40K/50K/65K	125	120-277V	White

Note: Contact for custom configuration & specifications

Product Dimensions

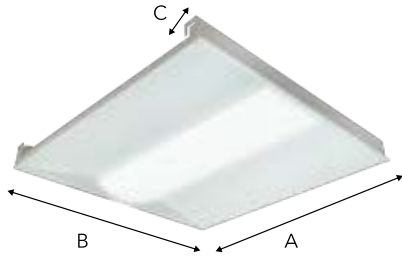

	TRO2-20T40-5CCT-DV2-WH		TRO4-20T50-5CCT-DV2-WH
A	23.7 in	A	47.8 in
B	23.7 in	B	23.7 in
C	2.0 in	C	2.0 in

Packaging Dimensions

Catalog Number	Master Pack Quantity	Dimensions
TRO2-20T40-5CCT-DV2-WH	2	25.5 x 5.5 x 25.7 in
TRO4-20T50-5CCT-DV2-WH	2	49.5 x 25.7 x 5.5 in

Photometry

VPT2-20T30W-3CCT-DV2-GR

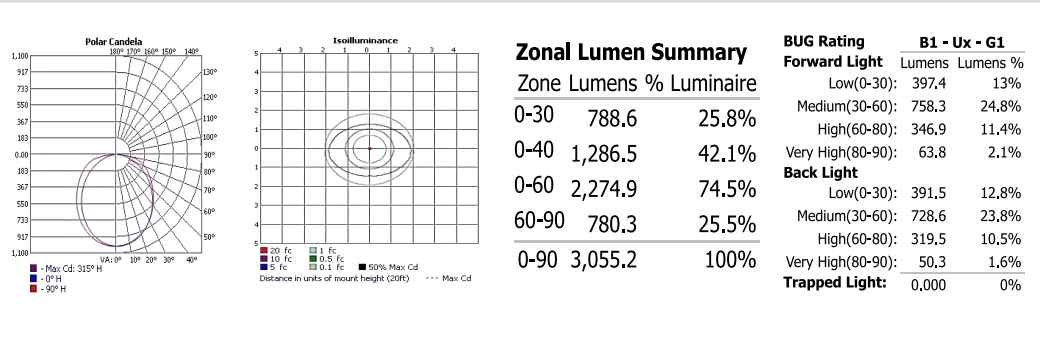

Note: Photometry available on request.

Accessories



PIR Motion Sensor
TRO-MS

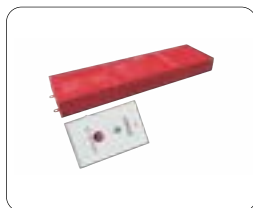





EM Battery Backup
TRO-EM

RETROFIT LED TROFFERS

RTRO Series

Light Up Your Environment: Modern Volumetric Troffer Solutions.



-  Easy Install
-  0-10V Dimming
-  120-277V
-  Lumen & Watt Selectable
-  White Color CCT Selectable

Product Features

Light Output: 3,750 - 6,250 Lumens

Wattage: 30 - 45 Watts

Replaces: Up to 175W Fluorescent

Efficacy: Up to 125LPW

CCT Selectable: 3500K/4000K/5000K

CRI Options: 80 CRI

Finish Color: White

Mounting: Recessed, Suspension Mount



Performance Specification

Model No.	Power (W)	Lumens (lm)	CCT (K)	LPW	Input Voltage	Finish
2 x 2 FT RTRO2-40W-CCT-DV2-NA-F-WHSM	30W	3,750	3500K	125	120-277V	White
	35W	4,375	4000K			
	40W	5,000	5000K			
2 x 4 FT RTRO4-30T50W-3CCT-DV2	30W	3,750	3500K	125	120-277V	White
	40W	5,000	4000K			
	50W	6,250	5000K			

Note: Contact for custom configuration & specifications

Product Dimensions



	RTRO2-40W		RTRO4-30T50W
A	23.8 in	A	47.8 in
B	23.8 in	B	23.8 in
C	3.1 in	C	3.1 in

Packaging Dimensions

Catalog Number	Master Pack Quantity	Dimensions
RTRO2-40W-CCT-DV2-NA-F-WHSM	2	22.7 x 22.7 x 10.1 in / 17.0lbs
RTRO4-30T50W-3CCT-DV2	2	49.7 x 24.7 x 10.3 in / 28.0lbs

Photometric Specification

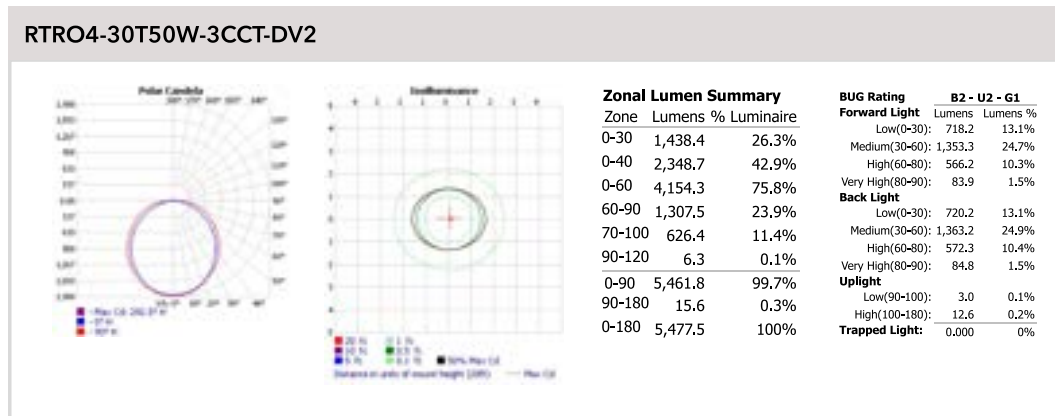





Note: Additional photometry available on request.

LINEAR LED HIGH BAYS

LHB Series

Light Up High Spaces



-  Easy Install
-  0-10V Dimming
-  120-277V
-  Wide Angle Optics
-  Versatile Mounting



Product Features

Light Output: 21,000 - 41,000 Lumens

Wattage: 135 - 270 Watts

Replaces: Up to 1000W MH

Efficacy: Up to 150LPW

CCT Options: 4000K

CRI Options: 80 CRI

Finish Color: White

Mounting: Suspension mount



Performance Specification

Model No.	Power (W)	Lumens (lm)	CCT (K)	LPW	Input Voltage	Finish
1.4 FT LHBS-135W-40K-DV2-NA-F-WHHM-4	135W	21,000	4000K	156	120-277V	White
2.6 FT LHBL-270W-40K-DV2-NA-F-WHHM-4	270W	41,000	4000K	152	120-277V	White

Note: Contact for custom configuration & specifications

Product Dimensions

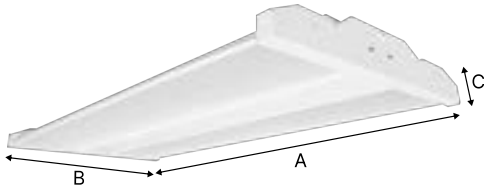

	LHBS-135W	LHBL-270W
A	16.5 in	31.1 in
B	10.2 in	10.2 in
C	1.8 in	1.8 in

Packaging Dimensions

Catalog Number	Master Pack Quantity	Dimensions
LHBS-135W-40K-DV2-NA-F-WHHM-4	4	17.7 x 11.1 x 8.7 in / 24.9lbs
LHBL-270W-40K-DV2-NA-F-WHHM-4	4	32.2 x 11.1 x 8.7 in / 42.1lbs

Photometric Specification

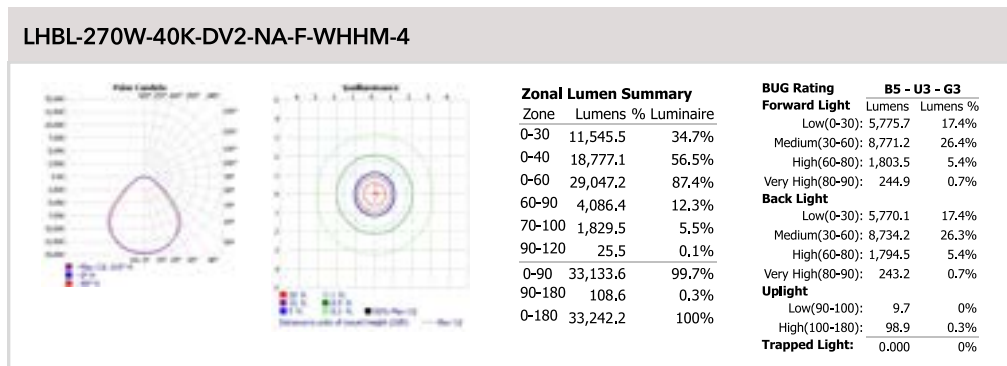

Note: Additional photometry available on request.

Accessories

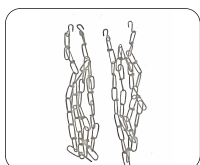

Chain Kit (included)

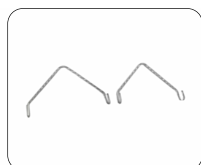







V-Hook (included)

LINEAR LED HIGH BAYS

LHB Series - CCT & Wattage Selectable

Light Up High Spaces



-  Easy Install
-  0-10V Dimming
-  120-277V
-  Wide Angle Optics
-  Versatile Mounting
-  CCT & Wattage Selectable
-  White Color Selectable

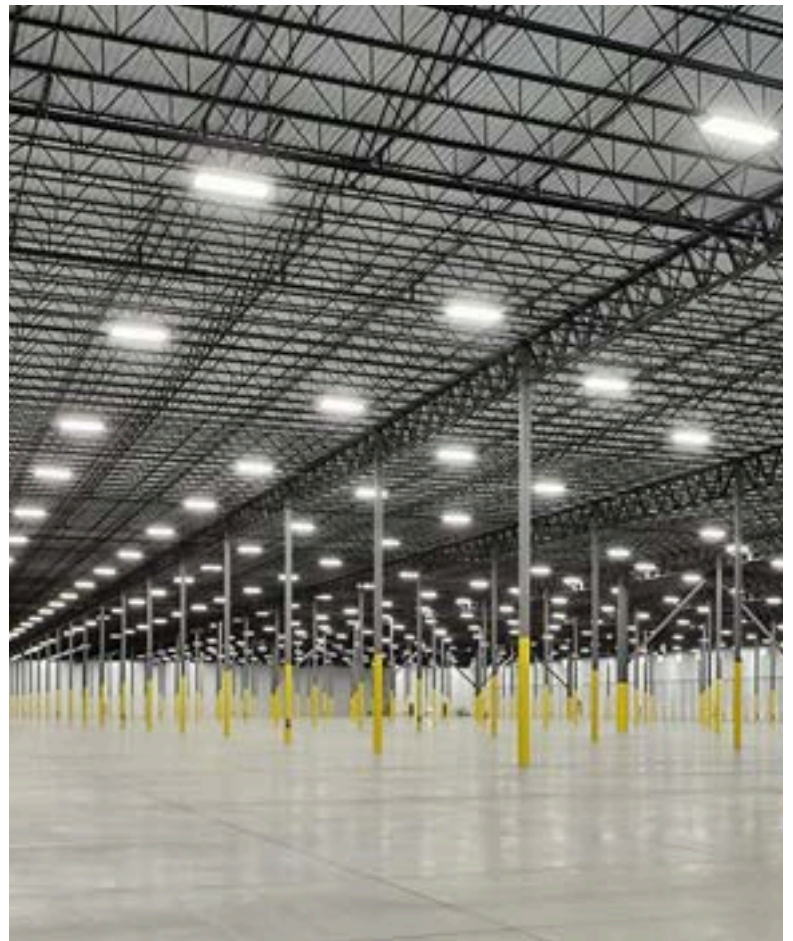

Product Features

Light Output: 10,500 - 45,500 Lumens

Wattage: 70 - 320 Watts

Replaces: Up to 1000W MH

Efficacy: Up to 150LPW

CCT Options: 3500K/4000K/5000K

CRI Options: 80 CRI

Finish Color: White

Mounting: Suspension mount



Performance Specification

Model No.	Power (W)	Lumens (lm)	CCT (K)	LPW	Input Voltage	Finish
70W-105W Selectable LHB-70T105W-3CCT-DV2-WH	70W 90W 105W	10,500 13,500 15,500	3500K 4000K 5000K	156-207	120-277V	White
110W-160W Selectable LHB-110T160W-3CCT-DV2-WH	110W 130W 160W	16,500 19,500 24,000	3500K 4000K 5000K	150-200	120-277V	White
165W-215W Selectable LHB-165T215W-3CCT-DV2-WH	165W 180W 215W	24,750 27,000 32,500	3500K 4000K 5000K	196	120-277V	White
255W-320W Selectable LHB-255T320W-3CCT-DV2-WH	255W 290W 320W	36,500 41,500 45,500	3500K 4000K 5000K	142-173	120-277V	White

Note: Contact for custom configuration & specifications

Product Dimensions

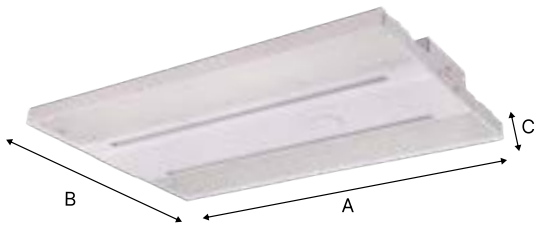

	LHB-70T105W	LHB-110T160W	LHB-165T215W	LHB-255T320W
A	14.2 in	18.1 in	18.1 in	23.0 in
B	11.0 in	11.8 in	11.8 in	12.6 in
C	1.8 in	1.8 in	1.8 in	1.8 in

Packaging Dimensions

Catalog Number	Master Pack Quantity	Dimensions
LHB-70T105W-3CCT-DV2-WH	1	15.0 x 11.8 x 2.8 in / 4.4lbs
LHB-110T160W-3CCT-DV2-WH	1	18.9 x 12.6 x 2.8 in / 6.16lbs
LHB-165T215W-3CCT-DV2-WH	1	18.9 x 12.6 x 2.8 in / 6.16lbs
LHB-255T320W-3CCT-DV2-WH	1	23.8 x 13.4 x 2.8 in / 8.58lbs

Photometric Specification

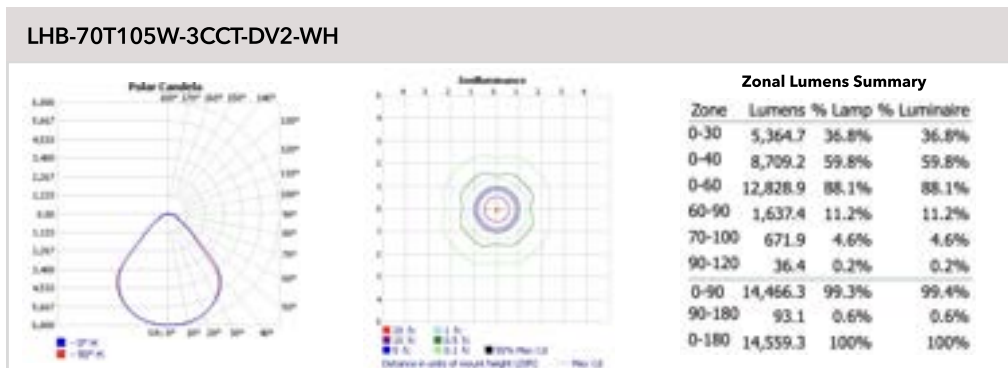

Note: Additional photometry available on request.

Accessories

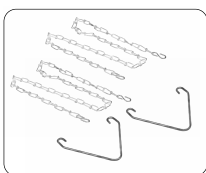

V-Hook and Chain
(Included)



Motion Sensor
LHB-DCM-MS



Remote Control
LHB-RC



Emergency
Battery Backup
LHB-EM

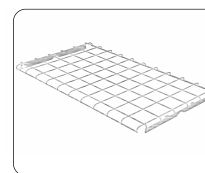

Wire Guard
LHB-WG-L
LHB-WG-M
LHB-WG-S



Pendant
Junction Box
LHB-PM



Surface Mount
Bracket
LHB-SM

ROUND LED HIGH BAYS

UFO Series

High Power, Low Cost



- Easy Install
- 0-10V Dimming
- Diecast Aluminum
- Motion Sensor Capable
- Wet Location Rated



Product Specifications

Light Output: 14,500 - 35,000 Lumens

Wattage: 100 - 240 Watts

Replaces: Up to 500W MH

Efficacy: Up to 145 LPW

CCT Options: 4000K or 5000K

CRI Options: 80 CRI

Finish Color: Bronze

Mounting: Pendant Mount



Performance Specification

Model No.	Power (W)	Lumens (lm)	CCT (K)	LPW	Input Voltage	Finish
UFOS-100W-40K-DV2-NA-90-BZHM UFOS-100W-50K-DV2-NA-90-BZHM	100W	14,500	4000K or 5000K	145	120-277V	Bronze
UFOM-150W-40K-DV2-NA-90-BZHM UFOM-150W-50K-DV2-NA-90-BZHM	150W	22,000	4000K or 5000K	145	120-277V	Bronze
UFOL-200W-40K-DV2-NA-90-BZHM UFOL-200W-50K-DV2-NA-90-BZHM	200W	29,000	4000K or 5000K	145	120-277V	Bronze
UFOX-240W-40K-DV2-NA-90-BZHM UFOX-240W-50K-DV2-NA-90-BZHM	240W	35,000	4000K or 5000K	145	120-277V	Bronze

Note: Contact for custom configuration & specifications

Product Dimensions

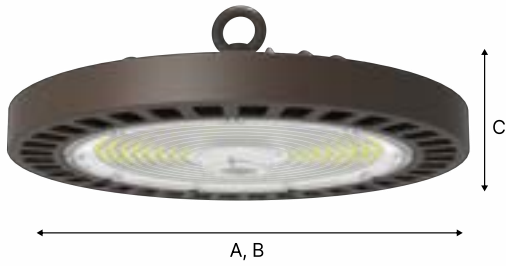

	UFOS-100W	UFOM-150W	UFOL-200W	UFOXL-240W
A	10.8 in	10.8 in	12.6 in	12.6 in
B	10.8 in	10.8 in	12.6 in	12.6 in
C	4.6 in	4.6 in	5.0 in	5.0 in

Packaging Dimensions

Catalog Number	Master Pack Quantity	Dimensions
UFOM-100W-50K-DV2-NA-90-BZHM	4	15.7 x 11.6 x 11.6 in / 20.3lbs
UFOM-150W-50K-DV2-NA-90-BZHM	4	15.7 x 11.6 x 11.6 in / 20.3lbs
UFOL-200W-50K-DV2-NA-90-BZHM	4	17.3 x 13.9 x 13.9 in / 28.2lbs
UFOXL-240W-50K-DV2-NA-90-BZHM	4	17.3 x 13.9 x 13.9 in / 28.2lbs

Photometric Specification

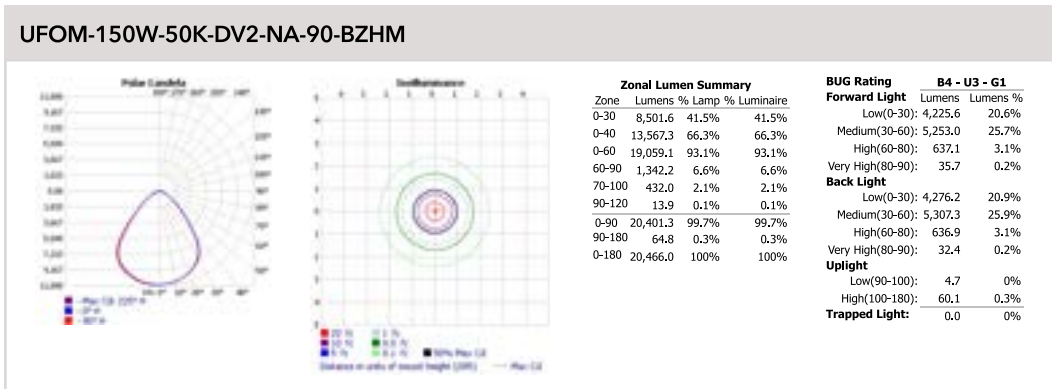

Note: Additional photometry available on request.

Accessories



Microwave Sensor
UFO-MS



Sensor Remote
UFO-RC



PC Reflector
UFO-90AC-REF



Pendant Junction Box
UFO-PM







Surface Mount Bracket
UFO-SMB

ROUND LED HIGH BAYS

UFO Series - 3 CCT Selectable

High Power, Low Cost



-  Easy Install
-  0-10V Dimming
-  Diecast Aluminum
-  Motion Sensor Capable
-  White Color Selectable

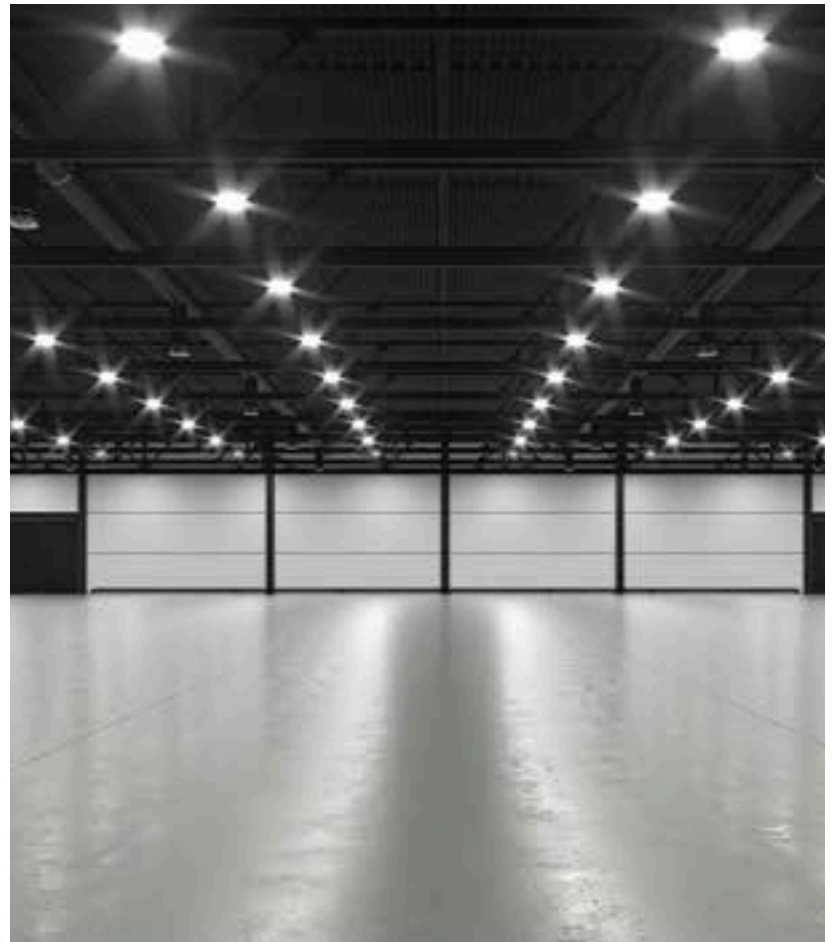

Product Specifications

Light Output: 15,000 - 48,000 Lumens

Wattage: 100 - 300 Watts

Replaces: Up to 1000W MH

Efficacy: Up to 160 LPW

CCT Selectable: 3500K/4000K/5000K

CRI Options: 80 CRI

Finish Color: Black, White

Mounting: Pendant Mount



Performance Specification

Model No.	Power (W)	Lumens (lm)	CCT (K)	LPW	Input Voltage	Finish
UFO-100T150W-3CCT-DV2-NA-90-BK	100W	16,000	3500K	160	120-277V	Black/White
UFO-100T150W-3CCT-DV2-NA-90-WH	120W	20,000	4000K			
	150W	24,000	5000K			
UFO-150T240W-3CCT-DV2-NA-90-BK	150W	24,000	3500K	160	120-277V	Black/White
UFO-150T240W-3CCT-DV2-NA-90-WH	200W	32,000	4000K			
	240W	38,400	5000K			
UFO-100T200W-3CCT-DV3-NA-90-WH	100W	15,000	3500K	150	277-480V	White
	150W	22,500	4000K			
	200W	30,000	5000K			
UFO-200T300W-3CCT-DV2-NA-90-BK	200W	32,000	3500K	160	120-277V	Black/White
UFO-200T300W-3CCT-DV2-NA-90-WH	240W	38,400	4000K	150	277-480V	
UFO-200T300W-3CCT-DV3-NA-90-BK	300W	48,000	5000K			
UFO-200T300W-3CCT-DV3-NA-90-WH						

Note: Contact for custom configuration & specifications

Product Dimensions



	UFO-100T150W	UFO-150T240W	UFO-200T3000W
A	27.6 in	31.0 in	33.0 in
B	27.6 in	31.0 in	33.0 in
C	6.10 in	6.10 in	7.0 in

Packaging Dimensions

Catalog Number	Master Pack Quantity	Dimensions
UFO-100T150W-3CCT-DV2-NA-90-xx	1	11.6 x 11.6 x 5.51 in / 5.5lbs
UFO-150T240W-3CCT-DV2-NA-90-xx	1	12.9 x 12.9 x 5.71 in / 6.4lbs
UFO-100T200W-3CCT-DV3-NA-90-xx	1	12.9 x 12.9 x 5.71 in / 6.4lbs
UFO-200T300W-3CCT-DV2/DV3-NA-90-xx	1	14.6 x 14.6 x 6.1 in / 9.7lbs

Photometric Specification

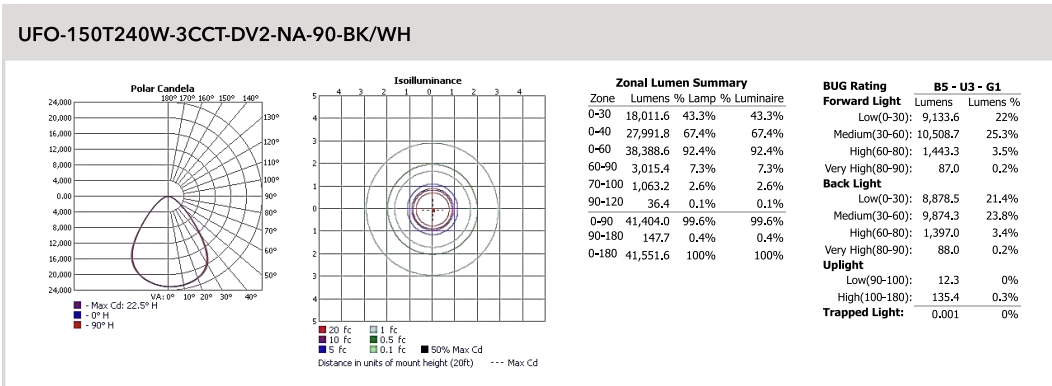

Note: Additional photometry available on request.

Accessories

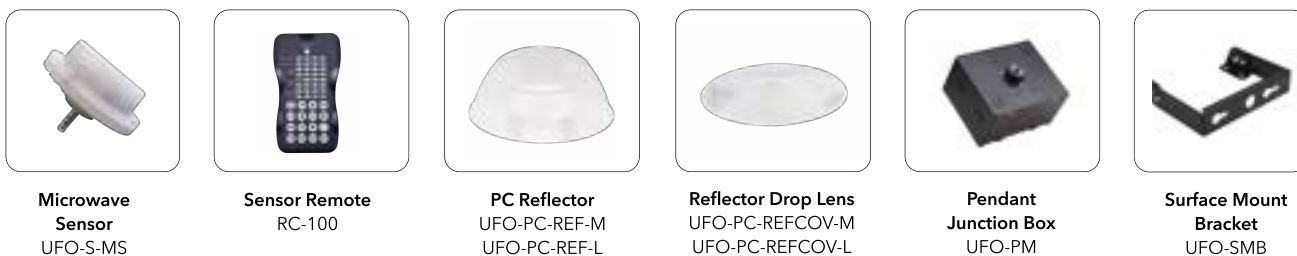

Microwave Sensor
UFO-S-MS

Sensor Remote
RC-100

PC Reflector
UFO-PC-REF-M
UFO-PC-REF-L

Reflector Drop Lens
UFO-PC-REFCOV-M
UFO-PC-REFCOV-L

Pendant Junction Box
UFO-PM





Surface Mount Bracket
UFO-SMB

LED VAPOR TIGHTS

VPT Series

Sealed for Strength, Powered for Performance



-  Easy Install
-  0-10V Dimming
-  120-277V
-  Lumen & Watt Selectable
-  White Color Selectable



Product Features

Light Output: 2,600 - 11,700 Lumens

Wattage: 20 - 90 Watts

Replaces: Up to 175W Fluorescent

Efficacy: Up to 130LPW

CCT Selectable: 35K/40K/50K

CRI Options: 80 CRI

Finish Color: Gray

Mounting: Surface Mount, Suspension Mount



Performance Specification

Model No.	Power (W)	Lumens (lm)	CCT (K)	LPW	Input Voltage	Finish
2 FT VPT2-20T30W-3CCT-DV2-GR	20W	2,600	3500K	130	120-277V	Gray
	25W	3,250	4000K			
	30W	3,900	5000K			
4 FT VPT4-40T60W-3CCT-DV2-GR	40W	5,200	3500K	130	120-277V	Gray
	50W	6,500	4000K			
	60W	7,800	5000K			
8 FT VPT8-60T90W-3CCT-DV2-GR	60W	7,800	3500K	130	120-277V	Gray
	75W	9,750	4000K			
	90W	11,700	5000K			

Note: Contact for custom configuration & specifications

Product Dimensions

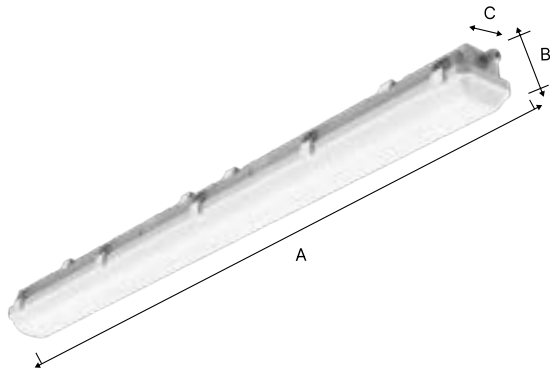

	VPT2-20T30W		VPT2-20T30W		VPT2-20T30W
A	23.6 in	A	47.2 in	A	94.2 in
B	4.3 in	B	4.3 in	B	4.3 in
C	3.4 in	C	3.4 in	C	3.4 in

Packaging Dimensions

Catalog Number	Master Pack Quantity	Dimensions
VPT2-20T30W-3CCT-DV2-GR	8	24.80 x 19.48 x 8.26 in / 2.98lbs
VPT4-40T60W-3CCT-DV2-GR	8	48.42 x 19.37 x 8.26 in / 5.95lbs
VPT2-20T30W-3CCT-DV2-GR	4	95.27 x 9.92 x 8.26 in / 10.91lbs

Photometric Specification

VPT2-20T30W-3CCT-DV2-GR

Zonal Lumen Summary			
Zone	Lumens	% Lamp	% Luminaire
0-30	1,169.4	22.6%	22.6%
0-40	1,907.5	36.9%	36.9%
0-60	3,383.1	65.4%	65.5%
60-90	1,357.5	26.3%	26.3%
70-100	974.5	18.9%	18.9%
90-120	398.2	7.7%	7.7%
0-90	4,740.6	91.7%	91.8%
90-180	424.4	8.2%	8.2%
0-180	5,165.0	99.9%	100%

BUG Rating			
Forward Light		B2 - U3 - G2	
	Lumens	Lumens	%
Low(0-30):	583.3	11.3%	
Medium(30-60):	1,101.6	21.3%	
High(60-80):	519.3	10%	
Very High(80-90):	156.2	3%	
Back Light			
Low(0-30):	586.7	11.3%	
Medium(30-60):	1,113.0	21.5%	
High(60-80):	524.9	10.2%	
Very High(80-90):	157.3	3%	
Uplight			
Low(90-100):	211.0	4.1%	
High(100-180):	213.2	4.1%	
Trapped Light:	2.7	0.1%	

Note: Additional photometry available on request.

Accessories

Mounting Bracket
(Included)

EM Battery Backup
VPT-BBU-8W

Microwave Sensor
VPT-MS

Wire Guard
VPT-4FT-WG
VPT-8FT-WG



DISCS & DOWNLIGHTS



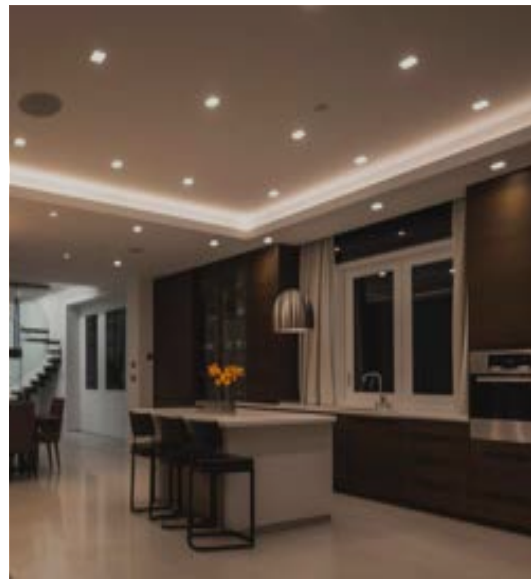
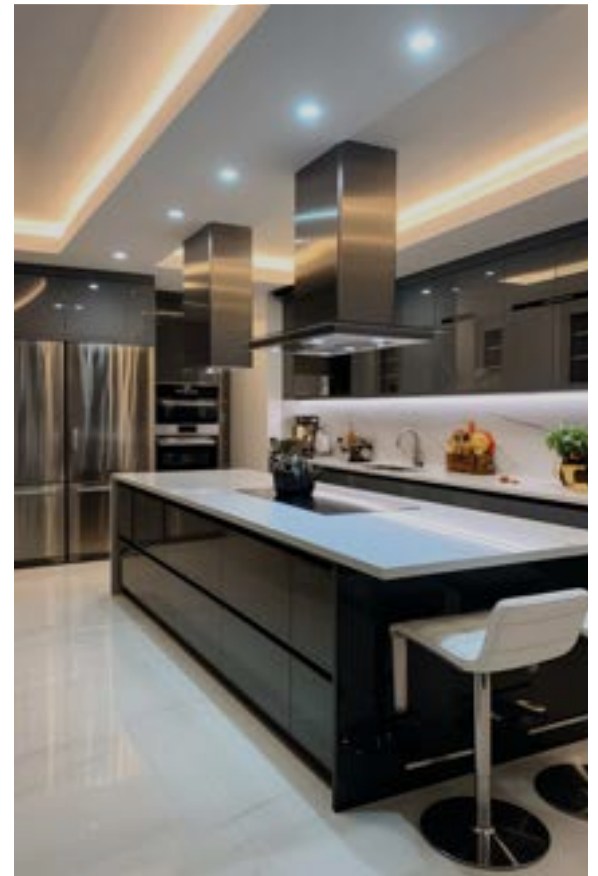





DISCS & DOWNLIGHTS

CANLESS J-BOX DOWNLIGHTS

DLR Series

Recessed Radiance Reigns



-  Easy Install
-  Triac Dimming
-  120V
-  White Color Selectable



Product Specifications

Light Output: 1,000 Lumens

Wattage: 12 Watts

Replaces: 75W Incandescent

Efficacy: Up to 84LPW

CCT Selectable: 2700K/3000K/3500K/4000K/5000K

CRI Options: 80 CRI

Finish Color: White

Mounting: Dry Wall Recessed Tension Clips



Performance Specification

Model No.	Power (W)	Lumens (lm)	CCT (K)	LPW	Input Voltage	Dimming
6 in. DLR6-12W-CCT-DV1-NA-F-WH	12W	1,000	27K/30K/35K/40K/50K	84	120V	Triac

Product Dimensions

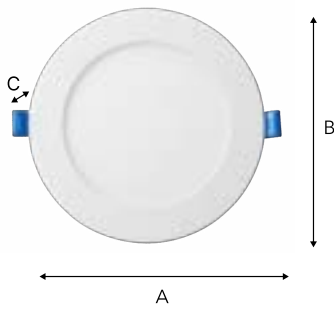

DLR6-12W	
A	6.7 in
B	6.7 in
C	1.1 in

Packaging Dimensions

Catalog Number	Master Pack Quantity	Dimensions
DLR6-12W-CCT-DV1-NA-F-WH	30	21.9 x 14.8 x 11.2 in / 29.5 lbs

Photometric Specification

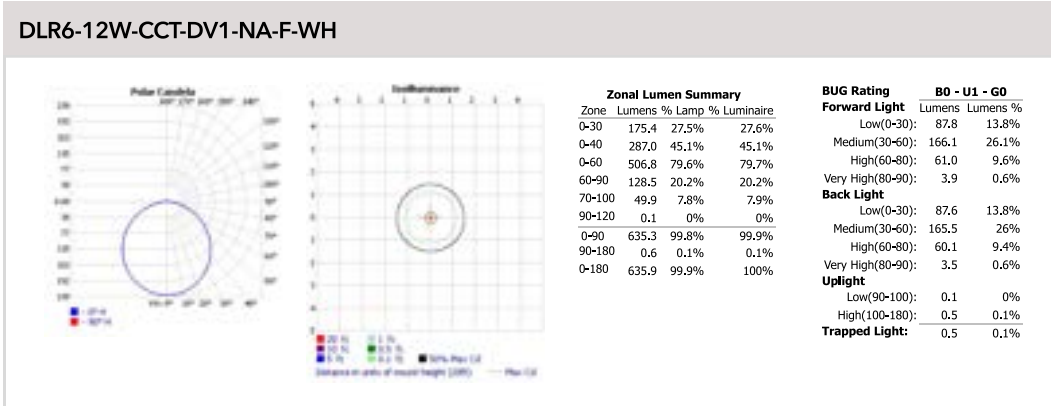

Note: Additional photometry available on request.

Accessories



Guide Plate
DLR-GP

Installation

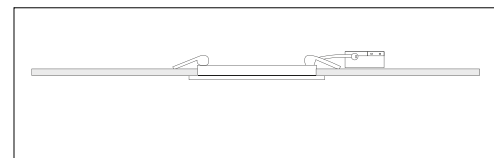
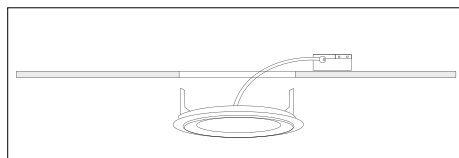





CANLESS J-BOX DOWNLIGHTS

DLR Series

Recessed Radiance Reigns



-  Easy Install
-  Triac Dimming
-  120V
-  White Color Selectable
-  Wet Location Rated



Product Specifications

Light Output: 700 - 1,440 Lumens

Wattage: 9 - 18 Watts

Replaces: 75W Incandescent

Efficacy: Up to 84LPW

CCT Selectable: 2700K/3000K/3500K/4000K/5000K

CRI Options: 90 CRI

Finish Color: White

Mounting: Dry Wall Recessed Tension Clips



Performance Specification

Model No.	Power (W)	Lumens (lm)	CCT (K)	LPW	Input Voltage	Dimming
4 in. DLR4-9W-5CCT-DV1-W-F-WH	9W	738	27K/30K/35K/40K/50K	82	120V	Triac
6 in. DLR6-12W-5CCT-DV1-W-F-WH	12W	1,000	27K/30K/35K/40K/50K	82	120V	Triac
8 in. DLR8-18W-5CCT-DV1-W-F-WH	18W	1,440	27K/30K/35K/40K/50K	80	120V	Triac

Product Dimensions

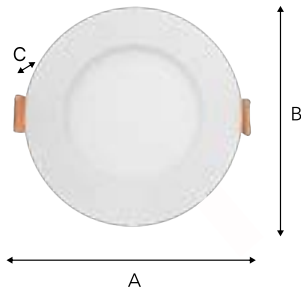

	DLR4-9W
A	4.9 in
B	4.9 in
C	0.8 in

	DLR6-12W
A	6.7 in
B	6.7 in
C	0.8 in

	DLR8-18W
A	8.3 in
B	8.3 in
C	0.8 in

Packaging Dimensions

Catalog Number	Master Pack Quantity	Dimensions
DLR4-9W-5CCT-DV1-W-F-WH	24	13.1 x 10.8 x 11.10 in / 18.3lbs
DLR6-12W-5CCT-DV1-W-F-WH	24	14.5 x 14.2 x 14.5 in / 23.1lbs
DLR8-18W-5CCT-DV1-W-F-WH	24	18.7 x 12.5 x 18.9 in / 31.9lbs

Photometric Specification

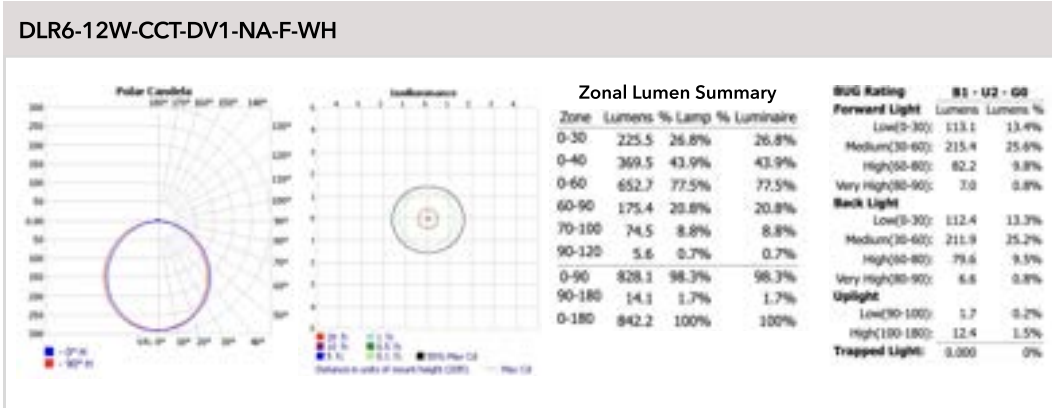

Note: Additional photometry available on request.

Accessories



New Construction Guide Plate
DL-GP

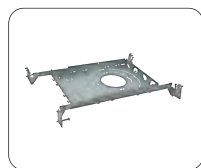

New Construction Nailer Bar Guide Plate
DL-NB-GP



Emergency Backup
DL-BBU-DV2-8W

Installation

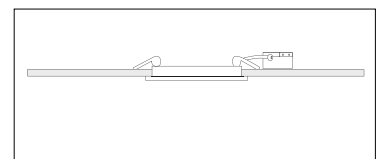
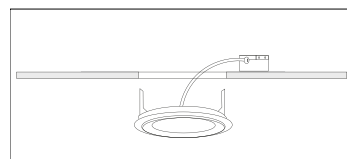





SQUARE DOWNLIGHTS

DLS Series

Effortlessly stylish lighting



-  Easy Install
-  Triac Dimming
-  120V
-  White Color Selectable

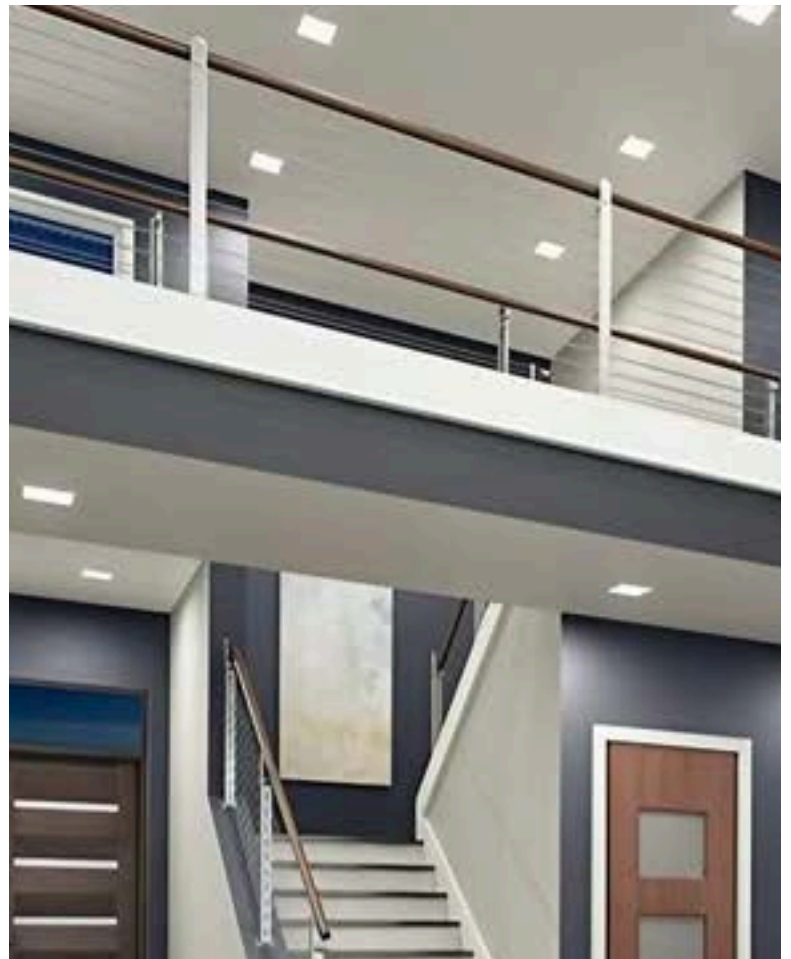

Product Features

Light Output: 700- 1,000 Lumens

Wattage: 9- 12 Watts

Replaces: 75W Incandescent

Efficacy: Up to 84 LPW

CCT Selectable: 2700K/3000K/3500K/4000K/5000K

CRI Options: 80 CRI

Finish Color: White

Mounting: J-Box Surface Mount, E26 Retrofit Can Installation



Performance Specification

Model No.	Power (W)	Lumens (lm)	CCT (K)	LPW	Input Voltage	Dimming
4 in. DLS4-9W-CCT-DV1-NA-F-WH	9W	700	27K/30K/35K/40K/50K	78	120V	Triac
7 in. DLS7-12W-CCT-DV1-NA-F-WH	12W	1,000	27K/30K/35K/40K/50K	84	120V	Triac

Product Dimensions

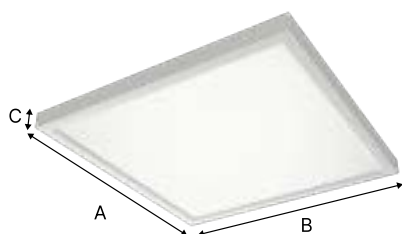

	DLS4-9W		DLS7-12W
A	5.0 in	A	7.5 in
B	5.0 in	B	7.5 in
C	1.1 in	C	1.3 in

Packaging Dimensions

Catalog Number	Master Pack Quantity	Dimensions
DLS4-9W-CCT-DV1-NA-F-WH	40	22.0 x 11.6 x 10.6 in / 28.6lbs
DLS7-12W-CCT-DV1-NA-F-WH	40	20.5 x 16.5 x 16.1 in / 46.1lbs

Photometric Specification

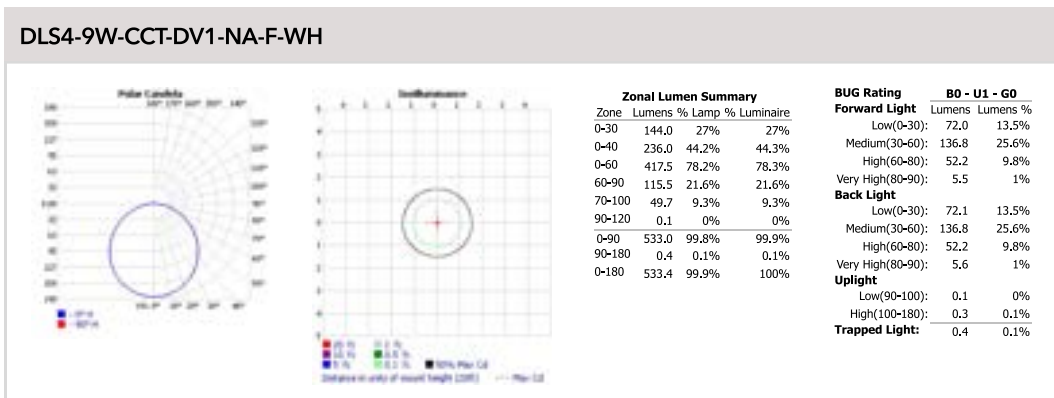

Note: Additional photometry available on request.

Installation

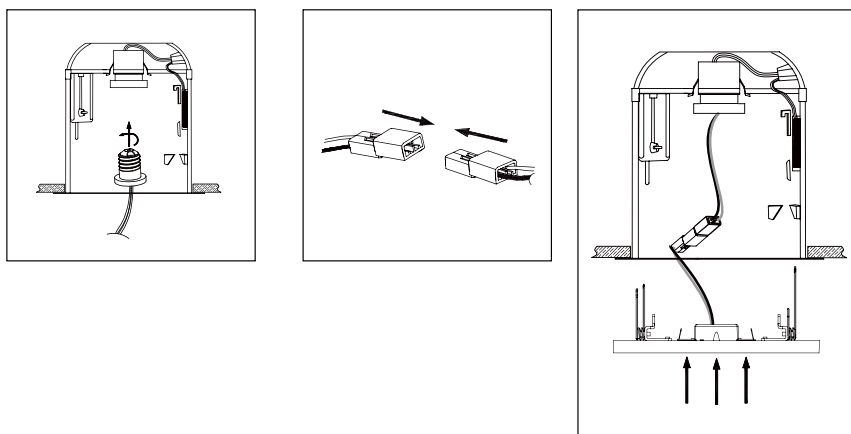





RETROFIT DOWNLIGHTS

RDLR Series

Effortlessly stylish lighting



-  Easy Install
-  Triac Dimming
-  120V
-  White Color Selectable

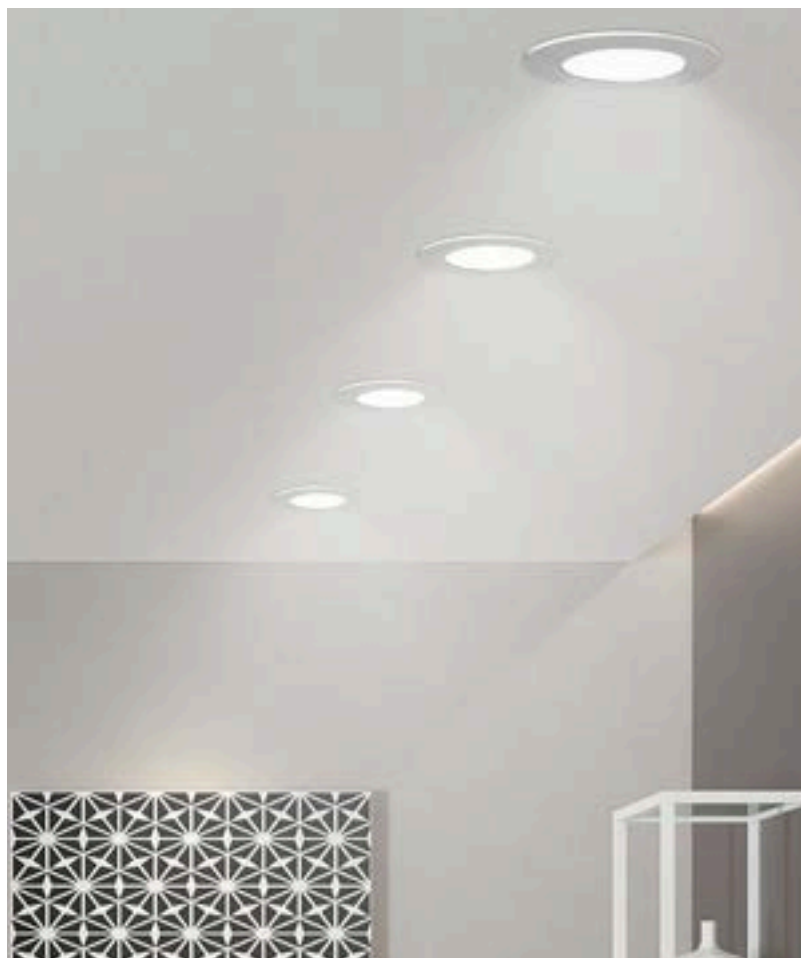

Product Features

Light Output: 600- 900 Lumens

Wattage: 9- 12 Watts

Replaces: Up to 75W Incandescent

Efficacy: Up to 75 LPW

CCT Selectable: 2700K/3000K/3500K/4000K/5000K

CRI Options: 80 CRI

Finish Color: White

Mounting: E26 Retrofit Spring Clip Can Installation



Performance Specification

Model No.	Power (W)	Lumens (lm)	CCT (K)	LPW	Input Voltage	Dimming
4 in. RDLR4-9W-CCT-DV1-NA-F-WH	9W	600	27K/30K/35K/40K/50K	78	120V	Triac
6 in. RDLR6-12W-CCT-DV1-NA-F-WH	12W	900	27K/30K/35K/40K/50K	84	120V	Triac

Note: Contact sales for JA8 options.

Product Dimensions

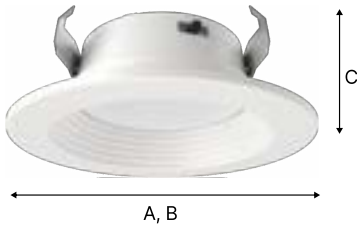

	RDLR4-9W		RDLR6-12W
A	5.0 in	A	7.4 in
B	5.0 in	B	7.4 in
C	1.7 in	C	2.3 in

Packaging Dimensions

Catalog Number	Master Pack Quantity	Dimensions
RDLR4-9W-CCT-DV1-NA-F-WH	40	22.0 x 11.8 x 11.4 in / 17.6lbs
RDLR6-12W-CCT-DV1-NA-F-WH	30	23.8 x 16.5 x 13.6 in / 22.4lbs

Photometric Specification

RDLR4-9W-CCT-DV1-NA-F-WH

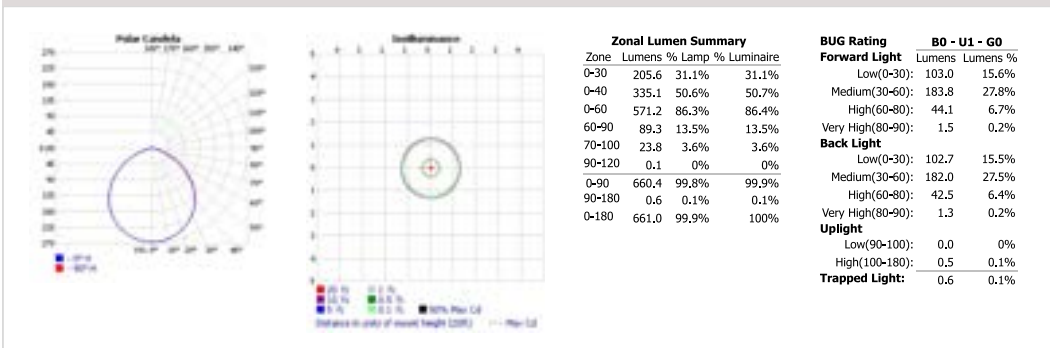

Note: Additional photometry available on request.

Installation

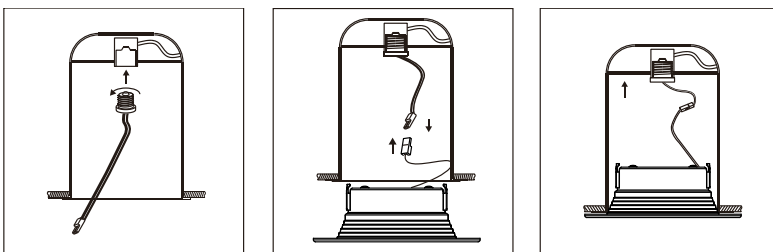





LED DISC LIGHT

DSCR Series

Advanced lighting made simple



-  Easy Install
-  Triac Dimming
-  120V
-  White Color Selectable

Product Specifications

Light Output: 1,000 Lumens

Wattage: 15 Watts

Replaces: Up to 75W Incandescent

Efficacy: Up to 67 LPW

CCT Selectable: 2700K/3000K/3500K/4000K/5000K

CRI Options: 80 CRI

Finish Color: White

Mounting: J-Box Surface Mount, E26 Retrofit Spring Clip Can Installation



Performance Specification

Model No.	Power (W)	Lumens (lm)	CCT (K)	LPW	Input Voltage	Dimming
6 in. DSCR6-15W-CCT-DV1-NA-F-WH	15W	1,000	27K/30K/35K/40K/50K	67	120V	Triac

Note: Contact sales for JA8 options.

Product Dimensions

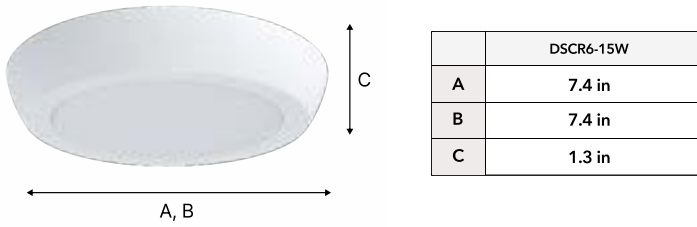

Packaging Dimensions

Catalog Number	Master Pack Quantity	Dimensions
DSCR6-15W-CCT-DV1-NA-F-WH	40	23.2 x 22.4 x 8.5 in / 28.2lbs

Photometric Specification

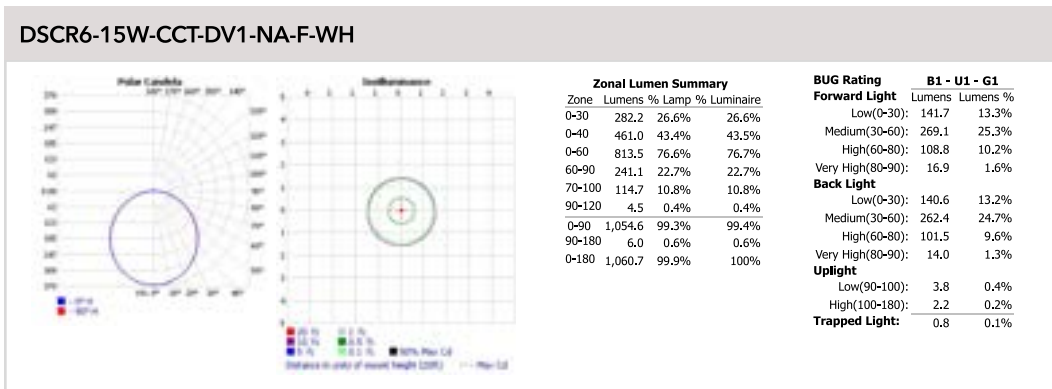

Note: Additional photometry available on request.

Installation

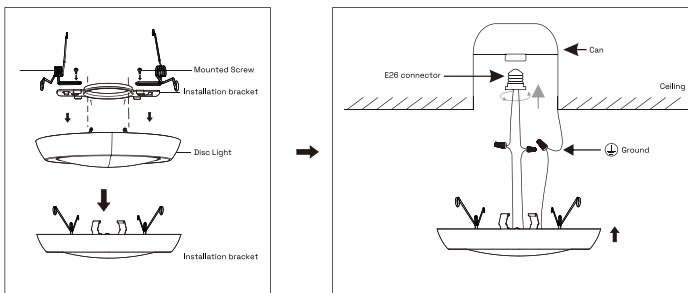

LED DISC LIGHT

DSCR Series

Advanced lighting made simple



- Easy Install
- Triac Dimming
- 120V
- White Color Selectable
- Wet Location Rated



Product Specifications

Light Output: 1,000 Lumens

Wattage: 15 Watts

Replaces: Up to 75W Incandescent

Efficacy: Up to 85 LPW

CCT Selectable: 2700K/3000K/3500K/4000K/5000K

CRI Options: 90 CRI

Finish Color: White

Mounting: J-Box Surface Mount



Performance Specification

Model No.	Power (W)	Lumens (lm)	CCT (K)	LPW	Input Voltage	Dimming
6 in. DSCR6-15W-5CCT-W	15W	1,000	27K/30K/35K/40K/50K	84+	120V	Triac

Product Dimensions

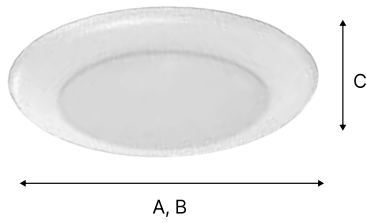

	DSCR6-15W-5CCT-W
A	7.3 in
B	7.3 in
C	0.9 in

Packaging Dimensions

Catalog Number	Master Pack Quantity	Dimensions
DSCR6-15W-5CCT-W	24	18.00 x 18.00 x 8.00 in / 16.00lbs

Photometric Specification

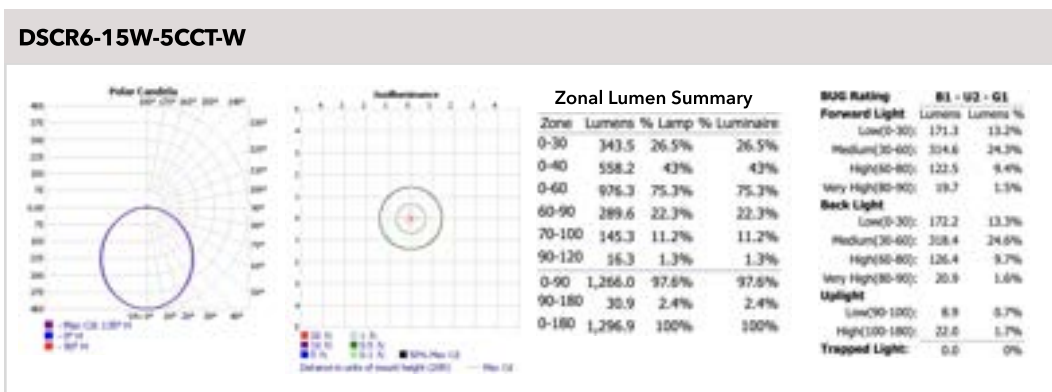

Note: Additional photometry available on request.

Installation

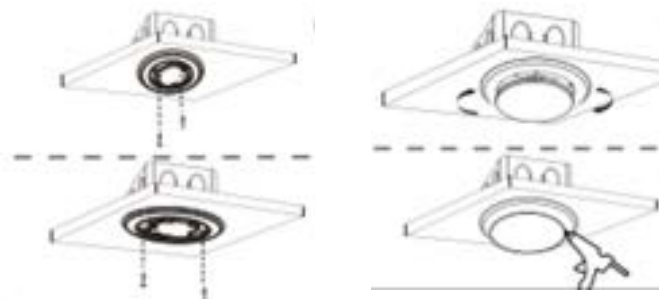







LED SLIM FLUSH MOUNTS

SFM Series

Modern Lighting for Every Space



-  Easy Install
-  Triac Dimming
-  120V
-  Lumen & Watt Selectable
-  White Color Selectable
-  Wet Location Rated

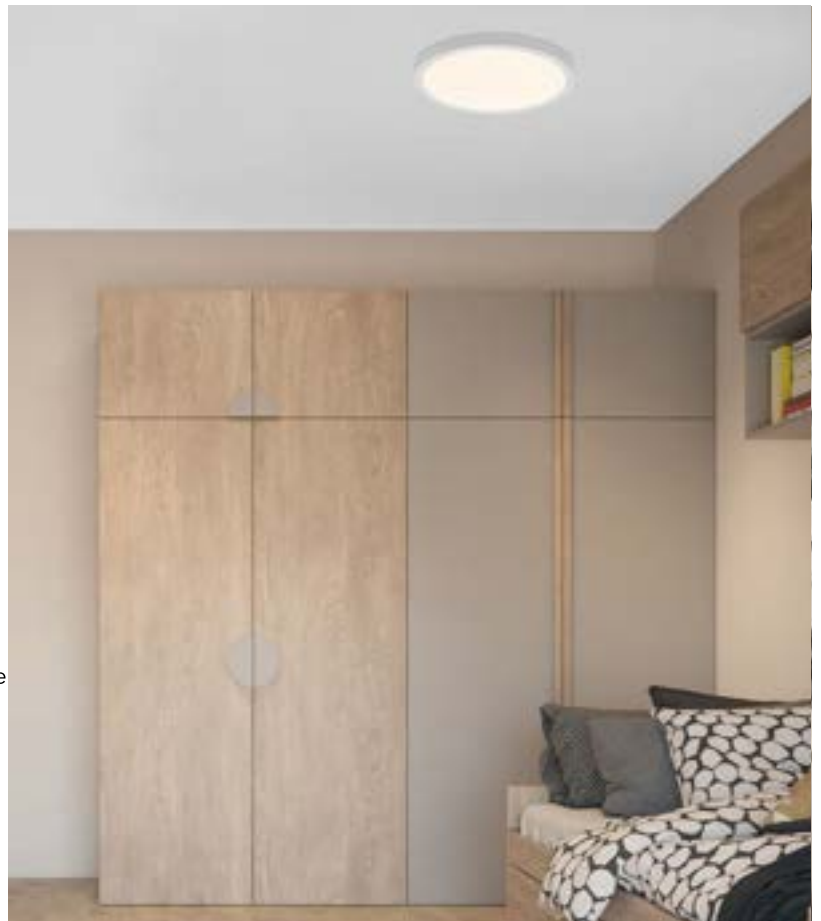

Product Features

Light Output: 650 - 2,000 Lumens

Wattage: 10 - 24 Watts

Replaces: Up to 120W Fluorescent

Efficacy: Up to 85LPW

CCT Selectable: 2700K/3000K/3500K/4000K/5000K

CRI Options: 90 CRI

Finish Color: White

Mounting: Surface Mount



Performance Specification

Model No.	Power (W)	Lumens (lm)	CCT (K)	LPW	Input Voltage	Finish
5 INCH SFM5-10W-5CCT-WH	10W	820	27K/30K/35K/40K/50K	70	120V	White
7 INCH SFM7-15W-5CCT-WH	15W	1,230	27K/30K/35K/40K/50K	82	120V	White
9 INCH SFM9-18W-5CCT-WH	18W	1,460	27K/30K/35K/40K/50K	82	120V	White
11 INCH SFM11-21W-5CCT-WH	21W	1800	27K/30K/35K/40K/50K	82	120V	White
13 INCH SFM13-24W-5CCT-WH	24W	2,000	27K/30K/35K/40K/50K	84	120V	White

Note: Contact for custom configuration & specifications

Product Dimensions

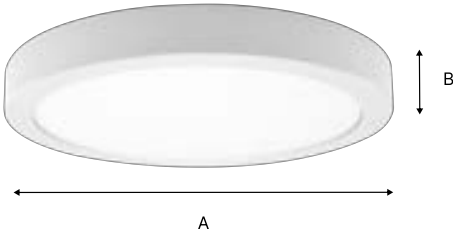

	SFM5-10W		SFM7-15W
A	5.5 in	A	7.5 in
B	0.8 in	B	0.8 in

	SFM9-18W		SFM11-21W		SFM13-24W
A	8.8 in	A	10.98 in	A	12.8 in
B	0.8 in	B	0.9 in	B	0.9 in

Packaging Dimensions

Catalog Number	Master Pack Quantity	Dimensions
SFM5-10W-5CCT-WH	24	14.37 x 12.00 x 6.77 in / 19.84lbs
SFM7-15W-5CCT-WH	24	15.98 x 14.17 x 8.58 in / 28.66lbs
SFM9-18W-5CCT-WH	24	18.82 x 14.17 x 9.92 in / 36.37lbs
SFM11-21W-5CCT-WH	12	16.22 x 11.73 x 12.13 in / 26.45lbs
SFM13-24W-5CCT-WH	12	16.22 x 13.46 x 13.78 in / 33.10lbs

Photometric Specification

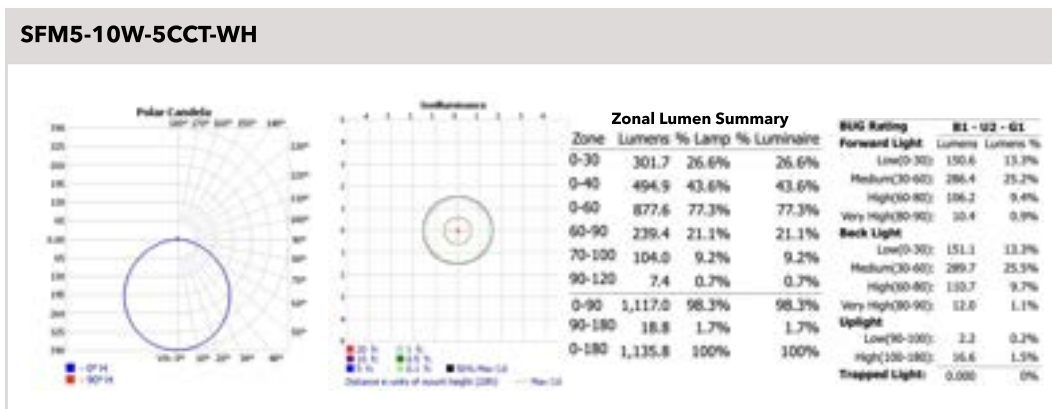

Note: Additional photometry available on request.

Accessories



Trims Clips
SFMx-T-BN



Trims Clips
SFMx-T-BK



Emergency Backup
DL-BBU-DV1-13W

A photograph of a modern exit door with a black frame and a glass panel. Above the door is a white rectangular sign with the word "EXIT" in red capital letters. The door is set in a light-colored wall. A dark mat is visible on the floor in front of the door.

EXIT

EXIT &
EMERGENCY
LIGHTING

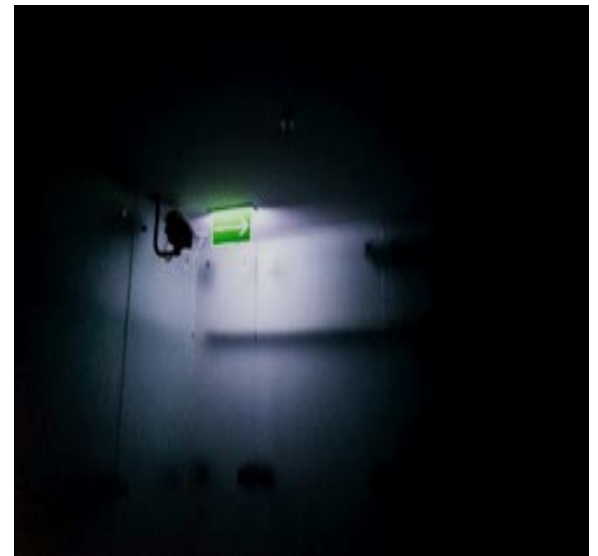





EXIT & EMERGENCY LIGHTING

EXIT SIGNS

ES-C-S Series

Life-saving illumination



-  Easy Install
-  90 Minute Emergency Egress
-  120/277V
-  Battery Powered
-  RED & GREEN EXIT Letters

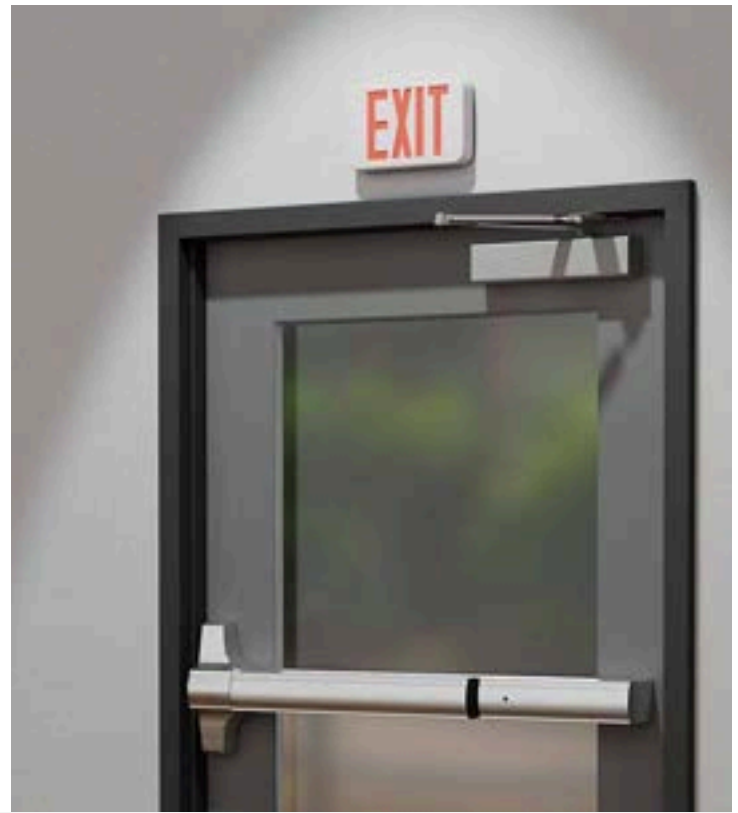

Product Specifications

Battery: Built-in 1.2V 1000mAh Ni-Cd battery

Voltage: 120/277V

Emergency Run Time: 90 minutes

Battery Charging Time: 24 hours

Housing: Injection-mold thermoplastic ABS housing, UL 94V-0 flame rating

Finish Color: White, Black

Mounting: Universal J-Box mounting

Letter Options: Red, Green



Performance Specification

Model No.	Voltage	Current (A)	Power (W)	LED Type	Charging Time	Emergency Run Time
ES-C-S-R-WH	120/277V	0.015-0.008A	1.9W	12 LEDs / RED letters	24 Hr	90 Min
ES-C-S-G-WH	120/277V	0.015-0.008A	1.9W	12 LEDs / GREEN letters	24 Hr	90 Min
ES-C-S-R-BK	120/277V	0.015-0.008A	1.9W	12 LEDs / RED letters	24 Hr	90 Min

Product Dimensions







	ES-C-S
A	11.6 in
B	7.4 in
C	1.7 in

EMERGENCY/EXIT SIGN COMBO

ESC-C-S Series

Evacuate with ease



-  Easy Install
-  90 Minute Emergency Egress
-  120/277V
-  Battery Powered
-  Selectable RED/GREEN

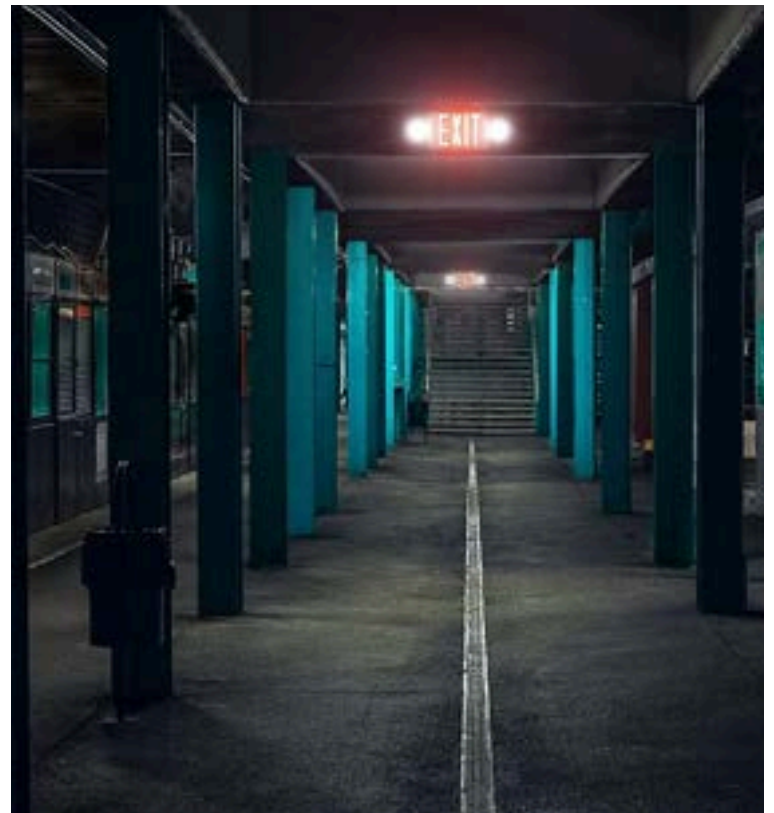

Product Specifications

Battery:

ESC-C-S-01 : Built-in 3.6V 1000mAh Ni-MH battery

ESC-C-S-02 : Built-in 3.6V 2000mAh Ni-MH battery

Voltage: 120/277V

Emergency Run Time: 90 minutes

Battery Charging Time: 24 hours

Housing: Injection-mold thermoplastic ABS housing,

UL 94V-0 flame rating

Finish Color: White

Mounting: Universal J-Box mounting

Letter Options: Selectable Red/Green



Performance Specification

Model No.	Voltage	Current (A)	Power (W)	LED Type	Charging Time	Emergency Run Time
ESC-C-S-01 ESC-C-S-02 (Remote Capable)	120/277V	0.032-0.017A 0.047-0.028A	2W 2.8W	6 LEDs for letters and two LED heads	24 Hr	90 Min

Product Dimensions







ESC-C-S-01/02	
A	16.5 in
B	7.2 in
C	2 in

WET LOCATION EXIT SIGN

ES-C-S-W Series

Efficient emergency guidance



-  Easy Install
-  90 Minute Emergency Egress
-  Battery Powered
-  RED EXIT Letter
-  Wet Location Rated



Product Specifications

Battery: Built-in 3.6V 1200mAh Ni-Mh battery

Voltage: 120/277V

Emergency Run Time: 90 minutes

Battery Charging Time: 24 hours

Housing: Injection-molded thermoplastic ABS housing and polycarbonate cover, UL 94V-0 flame rating

Finish Color: White

Mounting: Universal J-Box mounting

Letter Options: Red



Performance Specification

Model No.	Voltage	Current (A)	Power (W)	LED Type	Charging Time	Emergency Run Time
ES-C-S-W-R-WH	120/277V	0.026-0.015A	2.9W	10 LEDs / RED letters	24 Hr	90 Min

Product Dimensions

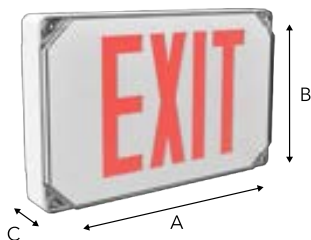





	ES-C-S-W-R-WH
A	12.5 in
B	8.0 in
C	2.5 in

WET LOCATION EXIT SIGN COMBO

ESC-S-W Series

Efficient emergency guidance



-  Easy Install
-  90 Minute Emergency Egress
-  Battery Powered
-  RED EXIT Letter
-  Wet Location Rated

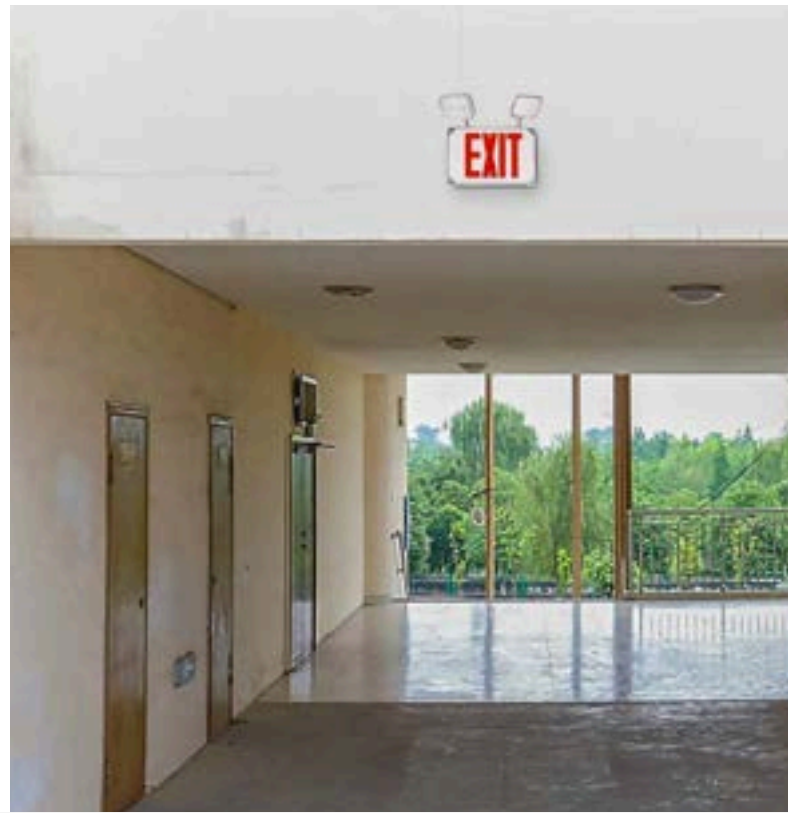

Product Specifications

Battery: Built-in 3.6V 1200mAh Ni-Mh battery

Voltage: 120/277V

Emergency Run Time: 90 minutes

Battery Charging Time: 24 hours

Housing: Injection-molded thermoplastic ABS housing and polycarbonate cover, UL 94V-0 flame rating

Finish Color: White

Mounting: Universal J-Box mounting

Letter Options: Red



Performance Specification

Model No.	Voltage	Current (A)	Power (W)	Lumens	LED Type	Charging Time	Emergency Run Time
ESC-S-W	120/277V	0.026-0.015A	2.9W	180	10 LEDs / RED letters	24 Hr	90 Min

Product Dimensions

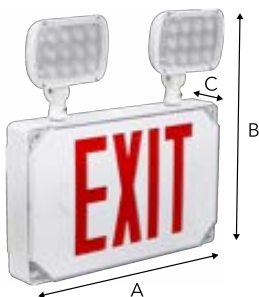





	ESC-S-W
A	12.5 in
B	13.3 in
C	2.56 in

EMERGENCY LIGHTS- SQUARE

DH-EL Series

Indoor Dual-Head Emergency Light



-  Easy Install
-  90 Minute Emergency Egress
-  120/277V
-  Battery Powered

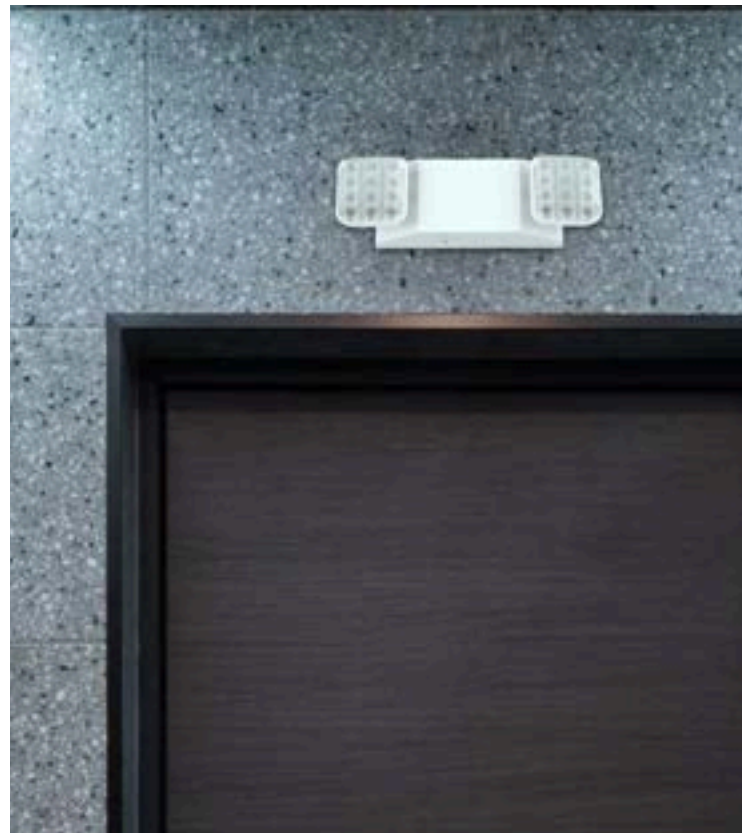

Product Specifications

Battery: Built-in 3.6V 1000mAh Ni-Cd battery

Light Output: 180 Lumens

Voltage: 120/277V

Housing: Injection-mold thermoplastic ABS housing, UL 94V-0 flame rating

Finish Color: White

Mounting: Universal J-Box mounting

Emergency Run Time: 90 minutes

Battery Charging Time: 24 hours



Performance Specification

Model No.	Voltage	Current (A)	Power (W)	LED Type	Charging Time	Emergency Run Time
DH-EL-SQ-WH	120/277V	0.020-0.010A	2.4W	24 LEDs for 2 Lamps	24 Hr	90 Min

Product Dimensions







	DH-EL-SQ
A	13.7 in
B	3.9 in
C	3.5 in

EMERGENCY LIGHTS- ROUND HEAD

DH-EL Series

Indoor Dual-Head Emergency Light



-  Easy Install
-  90 Minute Emergency Egress
-  120/277V
-  Battery Powered



Product Specifications

Battery: Built-in 3.6V 1000mAh Ni-Cd battery

Light Output: 180 Lumens

Voltage: 120/277V

Housing: Injection-mold thermoplastic ABS housing, UL 94V-0 flame rating

Finish Color: White

Mounting: Universal J-Box mounting

Emergency Run Time: 90 minutes

Battery Charging Time: 24 hours



Performance Specification

Model No.	Voltage	Current (A)	Power (W)	LED Type	Charging Time	Emergency Run Time
DH-EL-RD-WH	120/277V	0.020-0.010A	2W	24 LEDs for 2 Lamps	24 Hr	90 Min

Product Dimensions

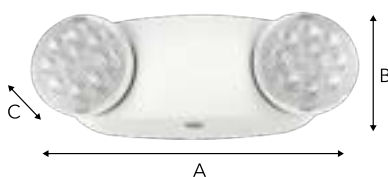





	DH-EL-RD-WH
A	11.0 in
B	4.3 in
C	2.6 in

WET LOCATION EMERGENCY LIGHT

DH-EL-W Series

Wet Location Dual Head
Emergency Light



-  Easy Install
-  90 Minute Emergency Egress
-  120/277V
-  Battery Powered
-  Wet Rated

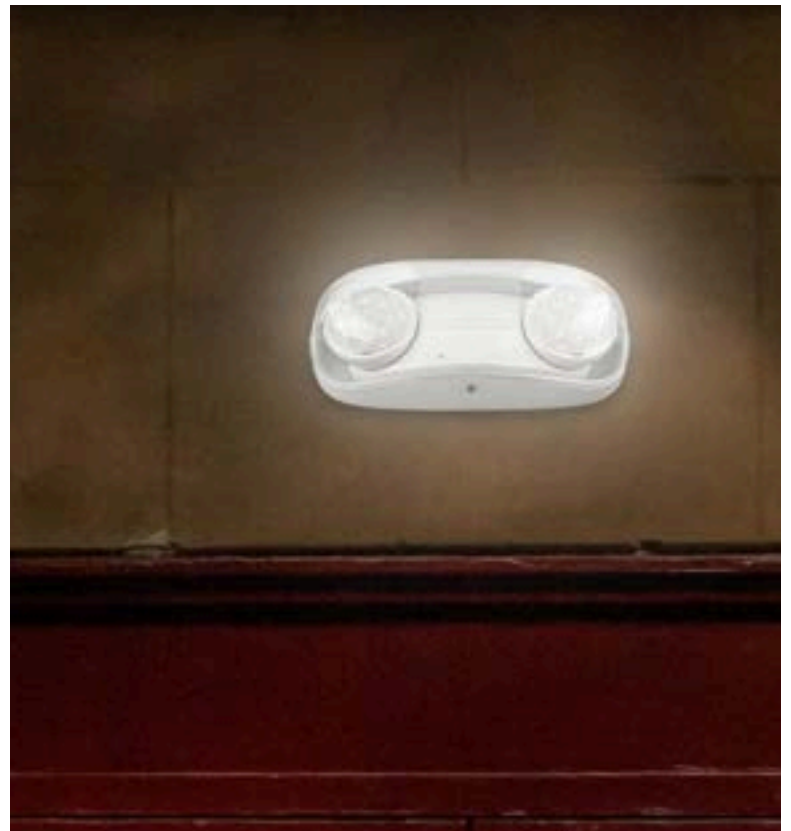

Product Specifications

Battery: Built-in 3.6V 2000mAh Ni-Cd battery

Light Output: 220 Lumens

Voltage: 120/277V

Housing: Injection-mold thermoplastic ABS housing, UL 94V-0 flame rating

Finish Color: White

Mounting: Universal J-Box mounting

Emergency Run Time: 90 minutes

Battery Charging Time: 24 hours



Performance Specification

Model No.	Voltage	Current (A)	Power (W)	LED Type	Charging Time	Emergency Run Time
DH-EL-W-WH	120/277V	0.025-0.010A	2.4W	24 LEDs for 2 Lamps	24 Hr	90 Min

Product Dimensions



	DH-EL-W
A	12.3 in
B	5.2 in
C	4.2 in

INDOOR REMOTE HEADS

ESC-02-IR Series

Indoor Single and Dual Emergency Remote Heads



- Easy Install
- 90 Minute Emergency Egress
- 120/277V
- Adjustable heads



Product Specifications

Light Output: 100 - 200 Lumens

Voltage: 120/277V

Finish Color: White

Housing: Injection-mold thermoplastic ABS housing, UL 94V-0 flame rating

Mounting: Universal J-Box mounting

Emergency Run Time: 90 minutes



Performance Specification

Model No.	Voltage	Power (W)	LED Type	Emergency Run Time
ESC-02-IR-1H-WH ESC-02-IR-2H-WH	120/277V	1.2W 2.4W	12 LEDs for 1 Lamps 24 LEDs for 2 Lamps	90 Min

Product Dimensions



ESC-02-IR-1H-WH	
A	4.7 in
B	4.3 in
C	3.1 in

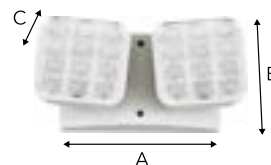





ESC-02-IR-2H-WH	
A	6.7 in
B	4.2 in
C	3.0 in

OUTDOOR REMOTE HEADS

ESC-02-OR Series

Outdoor Single Emergency Remote Heads



-  Easy Install
-  90 Minute Emergency Egress
-  120/277V
-  Adjustable heads
-  Wet Rated

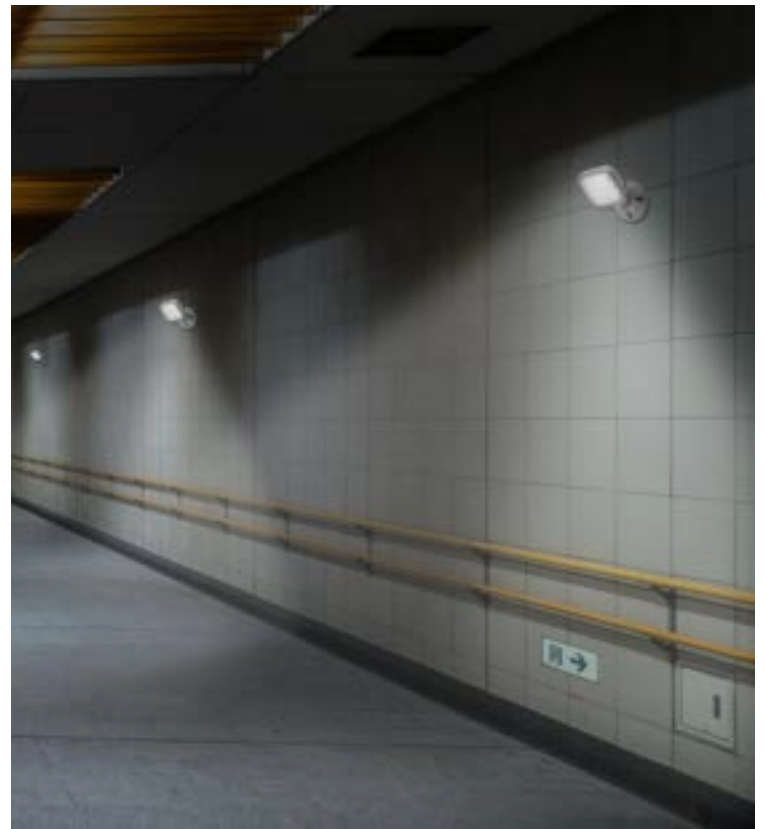

Product Specifications

Light Output: 100 Lumens

Voltage: 120/277V

Finish Color: White

Housing: Injection-mold thermoplastic ABS housing, UL 94V-0 flame rating

Mounting: Universal J-Box mounting

Emergency Run Time: 90 minutes



Performance Specification

Model No.	Voltage	Power (W)	LED Type	Emergency Run Time
ESC-02-OR-1H-WH	120/277V	1.2W	12 LEDs for 1 Lamp	90 Min
ESC-02-OR-2H-WH	120/277V	2.4W	24 LEDs for 2 Lamp	90 Min

Product Dimensions



ESC-02-OR-1H-WH	
A	3.7 in
B	6.4 in
C	4.4 in

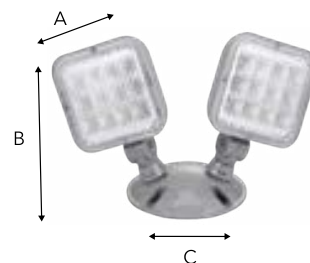

ESC-02-OR-2H-WH	
A	3.7 in
B	6.4 in
C	4.5 in

EDGE-LIT EXIT SIGNS

EDGE-ES Series

Sleek safety illumination

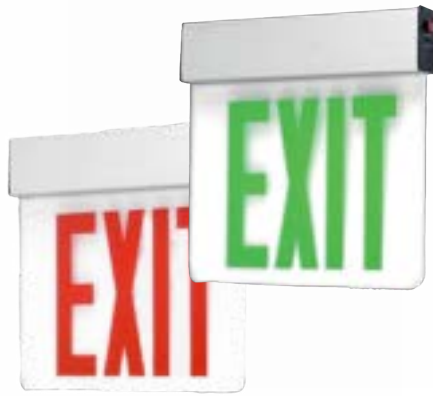

- Easy Install
- 120/277V
- Battery Powered
- Single Face

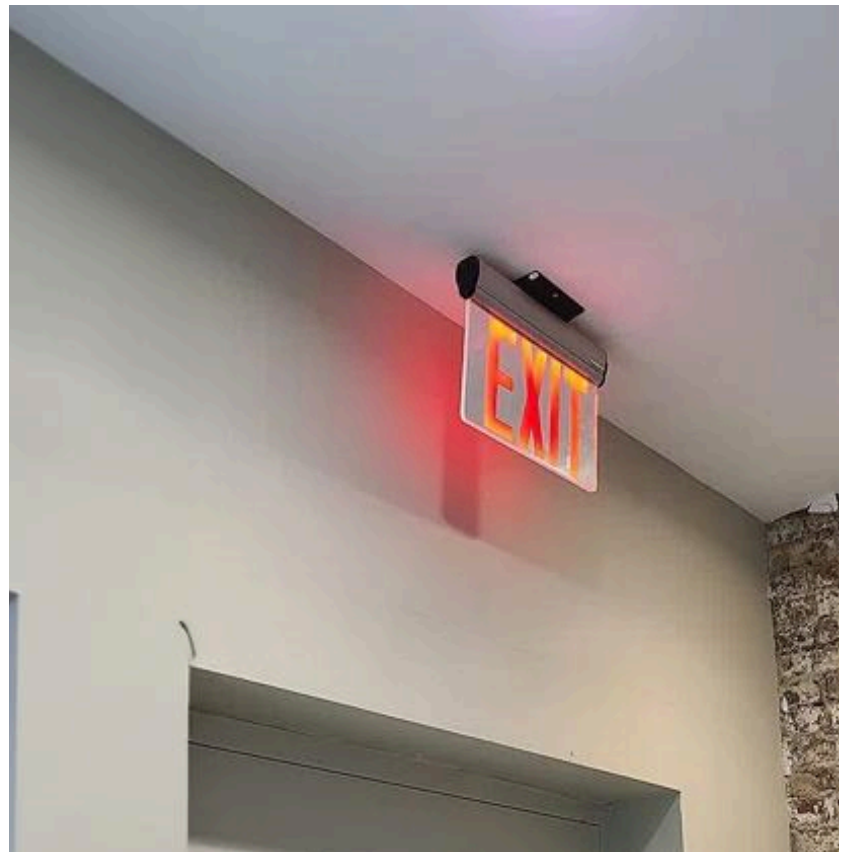

Product Specifications

Battery: Built-in 3.6V 600mAh Ni-Cd battery

Voltage: 120/277V

Emergency Run Time: 180 Minutes

Battery Charging Time: 24 hours

Housing: Aluminum housing with high grade acrylic panel.

Finish Color: Aluminum Housing and Clear Lens

Mounting: Aluminum mounting plate allows top, back or end mount

Letter Options: Red, Green



Performance Specification

Model No.	Voltage	Current (A)	Power (W)	LED Type	Charging Time	Emergency Run Time
EDGE-ES-01	120/277V	0.027-0.013A	3.5W	12 LEDs / RED letters	24 Hr	180 Min
EDGE-ES-02	120/277V	0.027-0.013A	3.5W	12 LEDs / GREEN letters	24 Hr	180 Min

Product Dimensions

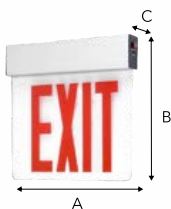

	EDGE-ES-01/02
A	12.7 in
B	10.7 in
C	1.6 in





EDGE-LIT EXIT SIGNS

WITH OPTIONAL INDICATORS

EDGE-ES Series

Efficient emergency guidance



-  Easy Install
-  120-277V
-  Battery Powered
-  RED EXIT Letter
-  Single Face

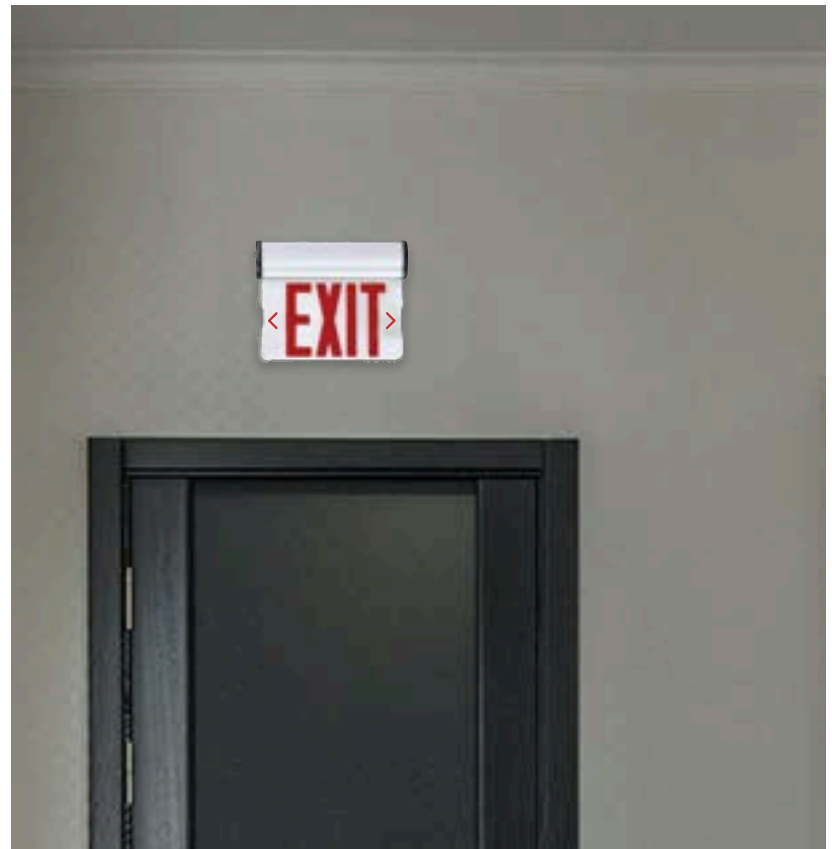

Product Specifications

Battery: Built-in 4.8V 400mAh Ni-Cd battery

Voltage: 120/277V

Emergency Run Time: 90 Minutes

Battery Charging Time: 24 hours

Housing: Aluminum housing with high grade acrylic panel.

Finish Color: Aluminum Housing and Clear Lens.

Mounting: Plastic mounting plate allows top, back or end mount

Letter Options: Red



Performance Specification

Model No.	Voltage	Current (A)	Power (W)	LED Type	Charging Time	Emergency Run Time
EDGE-ES-S-03	120/277V	0.035-0.025A	2.5W	8 LEDs / RED letters	24 Hr	90 Min

Product Dimensions

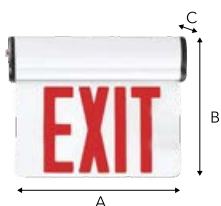

	EDGE-ES-03
A	12.1 in
B	9.8 in
C	1.8 in

DOUBLE SIDED EDGE-LIT EXIT SIGNS

EDGE-ES-2S Series

Sleek safety illumination



- Easy Install
- 120-277V
- Battery Powered
- Double Face



Product Specifications

Battery: Built-in 3.6V 600mAh Ni-Cd battery

Voltage: 120/277V

Emergency Run Time: 180 Minutes

Battery Charging Time: 24 hours

Housing: Aluminum housing with high grade acrylic panel

Finish Color: Aluminum Housing and Mirrored lens

Mounting: Aluminum mounting plate allows top, back or end mount

Letter Options: Red, Green



Performance Specification

Model No.	Voltage	Current (A)	Power (W)	LED Type	Charging Time	Emergency Run Time
EDGE-ES-2SR-S	120/277V	0.027-0.013A	3.5W	12 LEDs / RED letters	24 Hr	180 Min
EDGE-ES-2SG-S	120/277V	0.027-0.013A	3.5W	12 LEDs / GREEN letters	24 Hr	180 Min

Product Dimensions



	EDGE-ES-2SR/G
A	12.7 in
B	10.7 in
C	1.6 in

EMERGENCY WALL PACK

WEL Series

Strength, Safety, and Illumination Combined



- Die-cast Aluminum
- Easy Install
- 0-10V Dimming
- Wet Location Rated
- Integral Photocell
- White Color Selectable
- Emergency Backup



Product Features

Light Output: 1,800 Lumens

Wattage: 15 Watts

Replaces: Up to 20W MH

Efficacy: Up to 120 LPW

CCT Selectable: 3500K/4000K/5000K

CRI Options: 80 CRI

Finish Options: Bronze

Mounting: Wall Mount

Housing: Die-cast Aluminum

Lens type: Clear Drop Lens

EM: Emergency Battery Backup (UL 924 compliant)

Battery Li-ion battery: 3.7V/2500mAh

Battery Charging Current: 300mA max

Charging Time: ≥ 24Hours

Test Switch: Illuminated test switch, indicator light

Storage Temperature: -20°C to 85°C



Performance Specification

Model No.	Power (W)	Lumens (lm)	CCT (K)	LPW	Input Voltage	Finish
WEL-15W-3CCT-BZ	15W	1,800	3500K 4000K 5000K	120	120-277V	Bronze

Note: Contact for custom configuration & specifications

Product Dimensions



	WEL-15W-3CCT-BZ
A	10.5 in
B	6.5 in
C	3.7 in

Packaging Dimensions

Catalog Number	Master Pack Quantity	Dimensions
WEL-15W-3CCT-BZ	10	20.94 x 14.17 x 11.61in / 32.1lbs

Photometric Specification

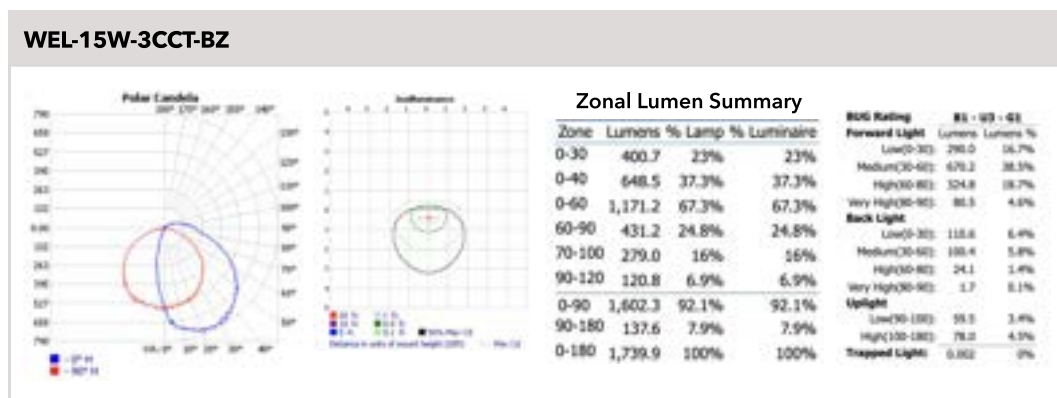

Note: Additional photometry available on request.

A photograph of a brick building at night. A modern, rectangular security light fixture is mounted on a silver pole against the brick wall. The light is illuminated, casting a glow. To the right, a dark door is visible. The overall scene is dimly lit, emphasizing the security lighting.

EXTERIOR
SECURITY
LIGHTS
& POLES

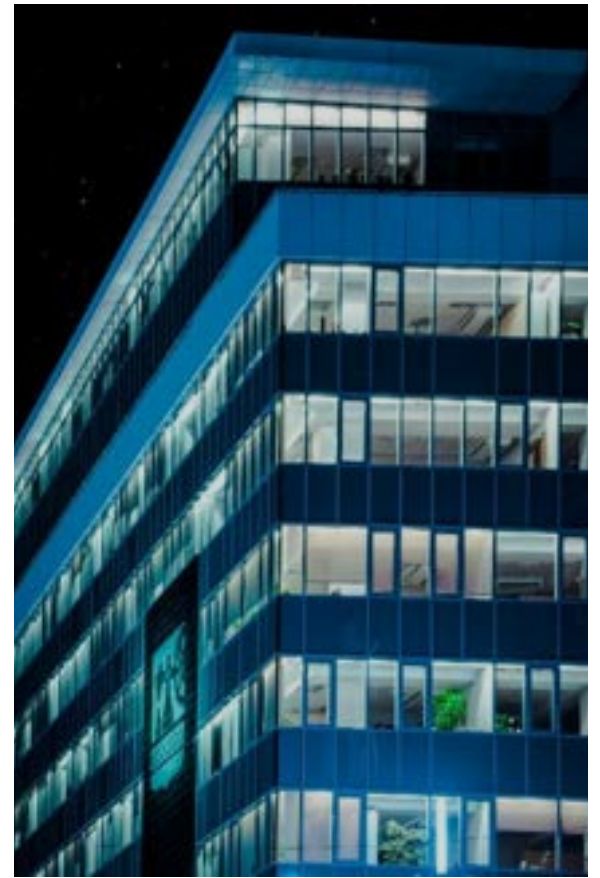
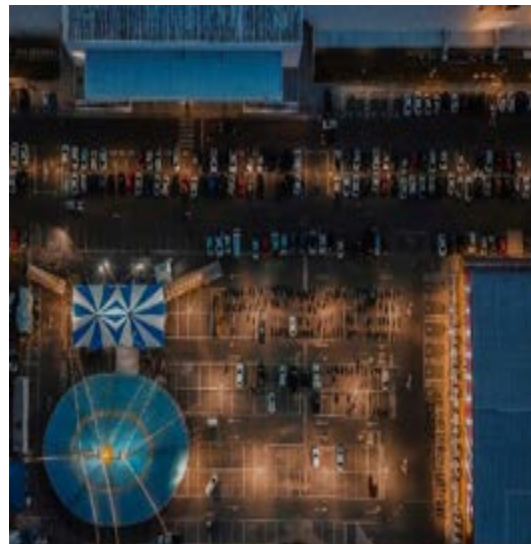

EXTERIOR SECURITY LIGHTS AND POLES

LED WALLPACKS

WPL Series

Shine Brighter, Farther.



- Die-cast Aluminum
- Easy Install
- 0-10V Dimming
- 120-277V
- Wet Location Rated
- Integral Photocell

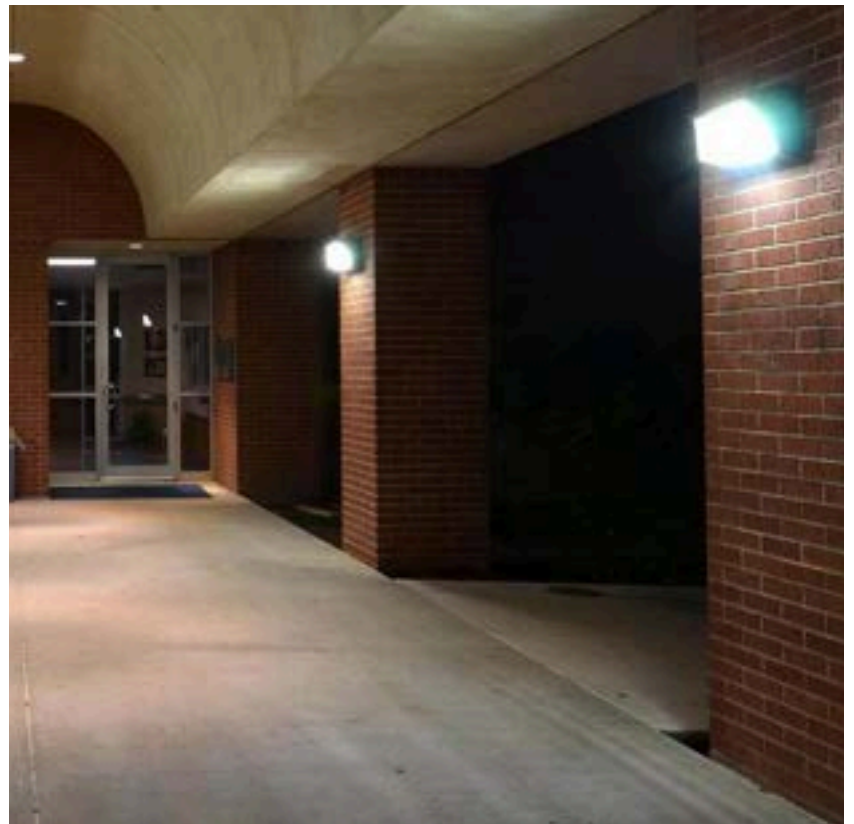

Product Features

Light Output: 8,000 - 14,000 Lumens

Wattage: 60 - 100 Watts

Replaces: Up to 200W MH

Efficacy: Up to 142 LPW

CCT Options: 4000K or 5000K

CRI Options: 80 CRI

Finish Options: Bronze

Mounting: Wall Mount

Housing: Die-cast Aluminum

Diffuser type: Polycarbonate



Performance Specification

Model No.	Power (W)	Lumens (lm)	CCT (K)	LPW	Input Voltage	Finish
WPLM-60W-40K-DV2-PC-CL-BZ	60W	8,000	4000K	134	120-277V	Bronze
WPLM-80W-40K-DV2-PC-CL-BZ WPLM-80W-50K-DV2-PC-CL-BZ	80W	11,000	4000K or 5000K	138	120-277V	Bronze
WPLL-100W-40K-DV2-PC-CL-BZ WPLL-100W-50K-DV2-PC-CL-BZ	100W	14,000	4000K or 5000K	140	120-277V	Bronze

Note: Contact for custom configuration & specifications

Product Dimensions



	WPLM-60W / 80W / 100W
A	13.1 in
B	9.6 in
C	5.0 in

Packaging Dimensions

Catalog Number	Master Pack Quantity	Dimensions
WPLM-60W-40K-DV2-PC-CL-BZ	2	14.7 X 11.8 X 10.9 in / 13.0 lbs
WPLM-80W-40K/50K-DV2-PC-CL-BZ	2	14.7 X 11.8 X 10.9 in / 13.0 lbs
WPLL-100W-40K/50K-DV2-PC-CL-BZ	2	14.7 X 11.8 X 10.9 in / 13.0 lbs

Photometric Specification

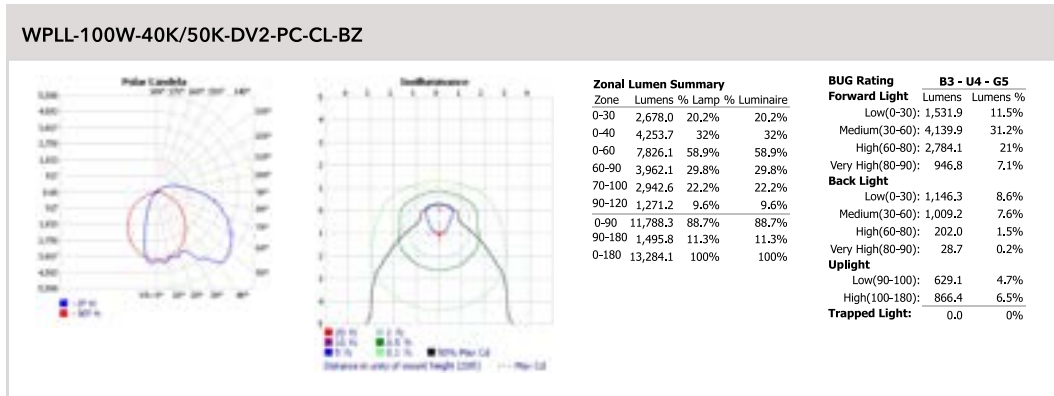







LED WALLPACKS

WPLL Series - 3 CCT Selectable

Shine Brighter, Farther.



-  Die-cast Aluminum
-  Easy Install
-  0-10V Dimming
-  Wet Location Rated
-  Integral Photocell
-  White Color Selectable



Product Features

Light Output: 6,000- 18,000 Lumens

Wattage: 40- 120 Watts

Replaces: Up to 200W MH

Efficacy: Up to 150 LPW

CCT Selectable: 3000K/4000K/5000K

CRI Options: 80 CRI

Finish Options: Bronze, White

Mounting: Wall Mount

Housing: Die-cast Aluminum

Diffuser type: Polycarbonate



Performance Specification

Model No.	Power (W)	Lumens (lm)	CCT (K)	LPW	Input Voltage	Finish
WPLL-40T80W-3CCT-DV2-PC-CL-BZ WPLL-40T80W-3CCT-DV2-PC-CL-WH	40W 60W 80W	6,000 9,000 12,000	3000K 4000K 5000K	150	120-277V	Bronze/White
WPLL-80T120W-3CCT-DV2-PC-CL-BZ WPLL-80T120W-3CCT-DV2-PC-CL-WH	80W 100W 120W	12,000 15,000 18,000	3000K 4000K 5000K	138	120-277V	Bronze/White

Note: Contact for custom configuration & specifications

Product Dimensions



	WPLL-40WT80W / 80WT120W
A	14.2 in
B	8.6 in
C	6.5 in

Packaging Dimensions

Catalog Number	Master Pack Quantity	Dimensions
WPLL-40T80W-3CCT-DV2-PC-CL-BZ/WH	1	16.1 X 9.4 X 11.4 in / 9.9 lbs
WPLL-80T120W-3CCT-DV2-PC-CL-BZ/WH	1	16.1 X 9.4 X 11.4 in / 9.9 lbs

Photometric Specification

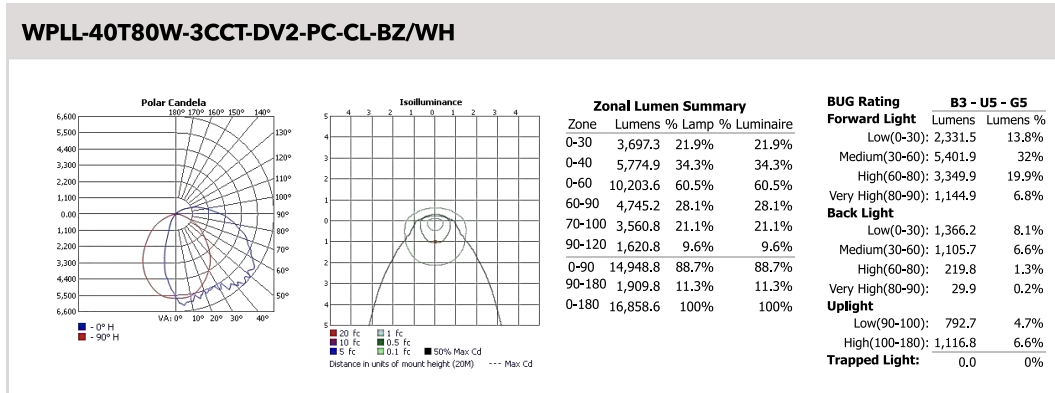

Note: Additional photometry available on request.

LED WALL PACKS

PowerWallX Series

Traditional with a modern touch



- Die-cast Aluminum
- Easy Install
- 0-10V Dimming
- 120-277V
- Wide Angle Optics
- Integral Photocell

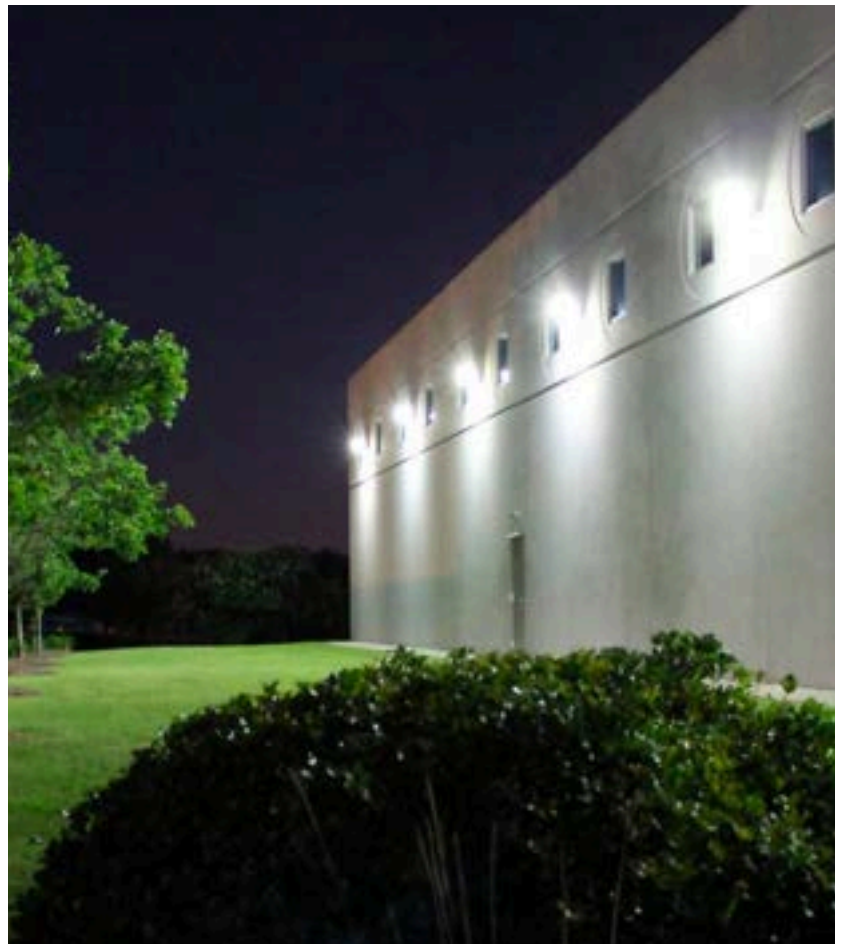

Product Features

Light Output: 3,500 - 10,000 Lumens

Wattage: 28 - 80 Watts

Replaces: Up to 150W MH

Efficacy: Up to 125 LPW

CCT Options: 4000K

CRI Options: 70 CRI

Finish Color: Bronze

Mounting: Wall Mount



Performance Specification

Model No.	Power (W)	Lumens (lm)	CCT (K)	LPW	Input Voltage	Finish
PRWX28-H-4K-BZ	28W	3,500	4000K	125	120-277V	Bronze
PRWX50-H-PC-4K-BZ PRWX50-H-PC-4K-WH	50W	6,500	4000K	130	120-277V	Bronze/White
PRWX80-H-PC-4K-BZ	80W	10,000	4000K	125	120-277V	Bronze

Note: Contact for custom configuration & specifications

Product Dimensions

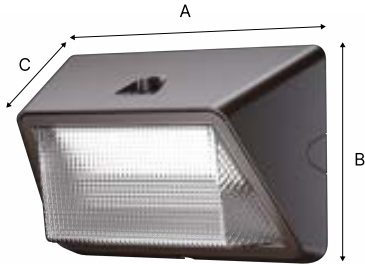

	PRWX28	PRWX50	PRWX80
A	9.4 in	11.4 in	13.1 in
B	6.1 in	7.9 in	9.2 in
C	4.3 in	5.4 in	6.2 in

Packaging Dimensions

Catalog Number	Master Pack Quantity	Dimensions
PRWX28-H-4K-BZ	4	16.4 x 12.7 x 11.3 in / 13.9 lbs
PRWX50-H-PC-4K-BZ/WH	3	22.8 x 13.3 x 10.2 in / 16.9 lbs
PRWX80-H-PC-4K-BZ	2	16.4 x 15.0 x 11.5 in / 16.2 lbs

Photometric Specification

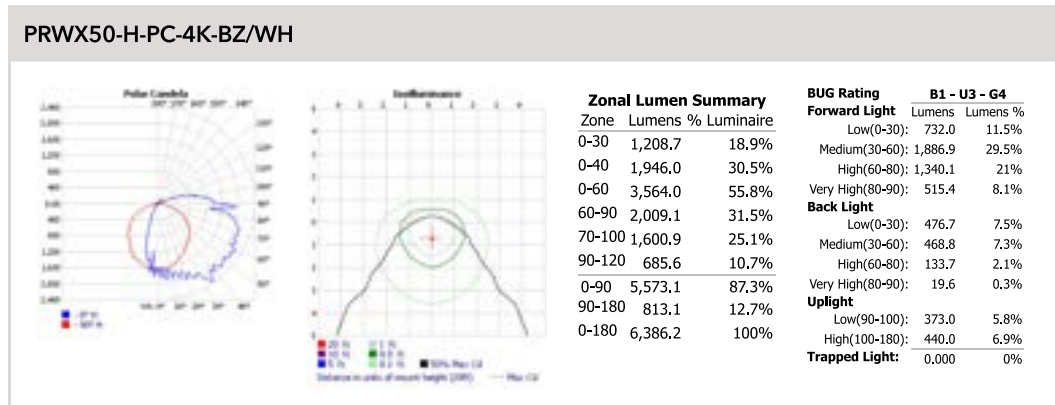

Note: Additional photometry available on request.

ADJUSTABLE CUT-OFF WALL PACKS

ACW Series

Bold design, powerful illumination



- Die-cast Aluminum
- Easy Install
- 0-10V Dimming
- 120-277V
- Beam Angle Adjustable
- Integral Photocell
- Emergency Backup



Product Features

Light Output: 1,200 - 18,000 Lumens

Wattage: 8 - 120 Watts

Replaces: Up to 200W MH

Efficacy: Up to 150 LPW

CCT Options: 3000K/4000K/5000K

CRI Options: 70 CRI

Finish Color: Bronze

Mounting: Wall Mount



Performance Specification

Model No.	Power (W)	Lumens (lm)	CCT (K)	LPW	Input Voltage	Finish
ACW-8T30W-3CCT-DV2-PC-BZ	8/15/25/30W	1,200 2,250 3,750 4,500	3000K 4000K 5000K	150	120-277V	Bronze
ACW-30T60W-3CCT-DV2-PC-BZ	30/40/50/60W	4,500 6,000 7,500 9,000	3000K 4000K 5000K	150	120-277V	Bronze
ACW-80T120W-3CCT-DV2-PC-BZ**	60/80/100/120W	9,000 12,000 15,000 18,000	3000K 4000K 5000K	150	120-277V	Bronze

**ACW-80T120W, MOQ and 90-120 day lead time

Product Dimensions



	ACW-8T30W ACW-30T60W	ACW-80T120W
A	10.7 in	13.0 in
B	8.9 in	9.3 in
C	4.4 in	5.6 in

Packaging Dimensions

Catalog Number	Master Pack Quantity	Dimensions
ACW-8T30W-3CCT-DV2-PC-BZ	2	11.3 x 9.0 x 10.3 in / 6.6lbs
ACW-30T60W-3CCT-DV2-PC-BZ	2	11.3 x 9.0 x 10.3 in / 6.6lbs
ACW-80T120W-3CCT-DV2-PC-BZ	2	13.7 x 12.2 x 10.7 in / 9.9lbs

Photometric Specification

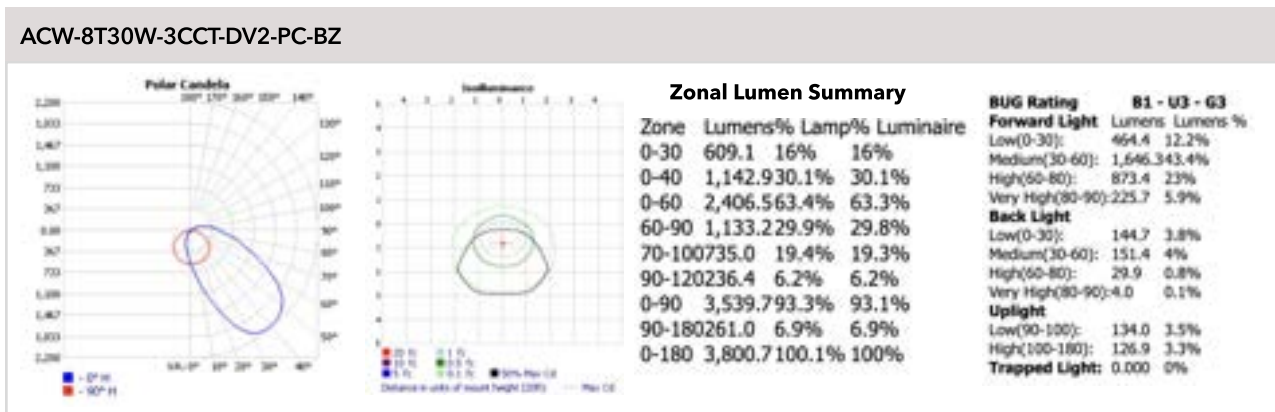

Note: Additional photometry available on request.

Accessories



EM Battery Backup

LED OVER DOOR WALL PACKS

MWP Series - 3 CCT Selectable

Maximize light, minimize size, unstoppable shine!



- Die-cast Aluminum
- Easy Install
- 0-10V Dimming
- Wet Location Rated
- Integral Photocell
- White Color Selectable

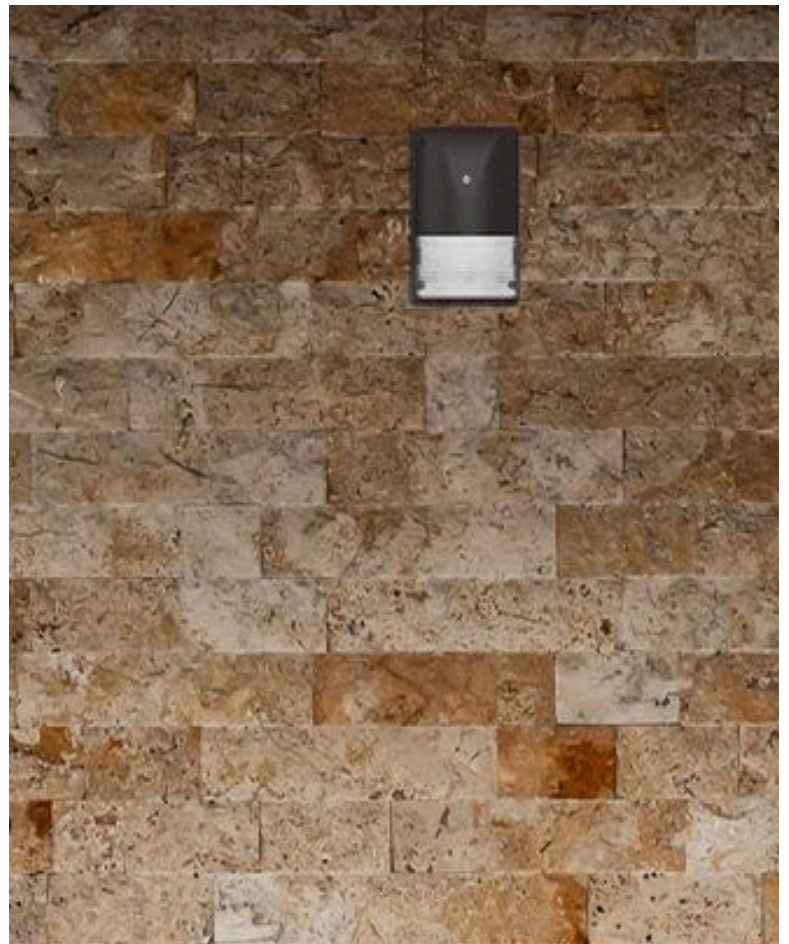

Product Features

Light Output: 2,025 - 4,050 Lumens

Wattage: 15 - 30 Watts

Replaces: Up to 100W MH

Efficacy: Up to 135 LPW

CCT Selectable: 3000K/4000K/5000K

CRI Options: 80 CRI

Finish Options: Bronze, White

Mounting: Wall Mount

Housing: Die-cast Aluminum

Diffuser type: Prismatic



Performance Specification

Model No.	Power (W)	Lumens (lm)	CCT (K)	LPW	Input Voltage	Finish
MWP-15T30W-3CCT-DV2-PC-CL-BZ	15W	2,025	3000K	135	120-277V	Bronze/White
MWP-15T30W-3CCT-DV2-PC-CL-WH	20W	2,700	4000K			
	30W	4,050	5000K			

Note: Contact for custom configuration & specifications

Product Dimensions



	MWP-15T30W
A	8.2 in
B	5.0 in
C	2.7 in

Packaging Dimensions

Catalog Number	Master Pack Quantity	Dimensions
MWP-15T30W-3CCT-DV2-PC-CL-BZ	10	16.4 x 12.2 x 9.4 in / 19.8lbs
MWP-15T30W-3CCT-DV2-PC-CL-WH	10	16.4 x 12.2 x 9.4 in / 19.8lbs

Photometric Specification

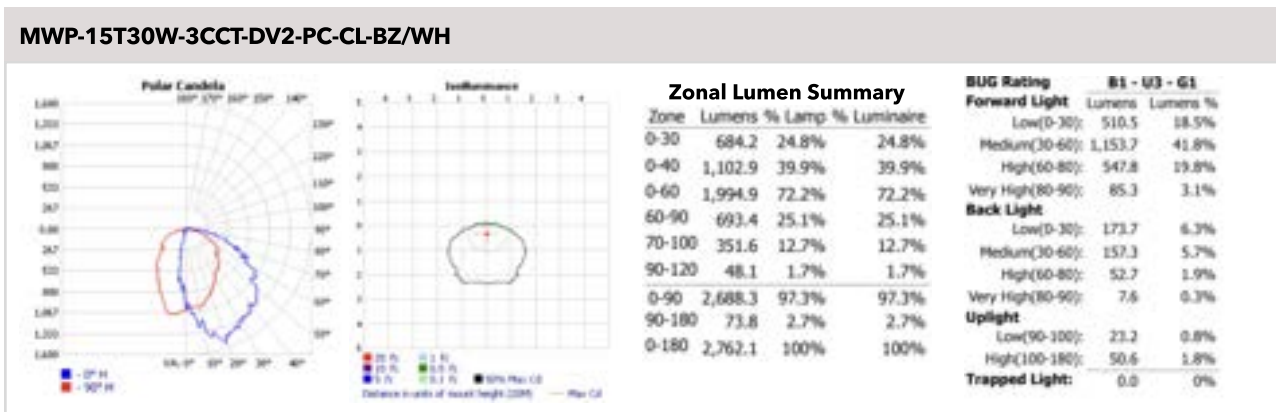

Note: Additional photometry available on request.

LED FLOOD LIGHT / WALL PACK COMBO

FusionX Series

Power and flexibility



- Die-cast Aluminum
- 120V
- Integral Photocell
- Precision Optics
- White Color Selectable



Product Features

Light Output: 1,600 - 8,000 Lumens

Wattage: 15 - 80 Watts

Replaces: Up to 100W MH

Efficacy: 107 LPW

CCT Selectable: 2700K/3000K/3500K/4000K/5000K

CRI Options: 70 CRI

Finish Options: Bronze, White

Mounting: Knuckle Mount & Wall Mount Bracket (included)



Performance Specification

Model No.	Power (W)	Lumens (lm)	CCT (K)	LPW	Input Voltage	Finish
FSNX15-5CCT-BZ FSNX15-5CCT-WH	15W	1,600	27K/30K/35K/40K/50K	107	120V	Bronze/White
FSNX28-5CCT-BZ FSNX28-5CCT-WH	28W	3,000	27K/30K/35K/40K/50K	107	120V	Bronze/White
FSNX50-PC-4K-BZ	50W	5,000	4000K	100	120V	Bronze
FSNX80-PC-4K-BZ	80W	8,000	4000K	100	120V	Bronze

Note: Contact for custom configuration & specifications

Product Dimensions

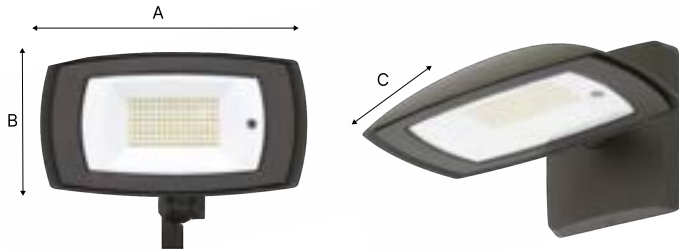

	FSNX15	FSNX28	FSNX50	FSNX80
A	7.7 in	8.7 in	9.9 in	11.0 in
B	4.4 in	4.8 in	5.8 in	6.3 in
C	1.3 in	1.4 in	1.6 in	2.0 in

Packaging Dimensions

Catalog Number	Master Pack Quantity	Dimensions
FSNX15-5CCT-BZ/WH	4	12.6 x 9.8 x 8.6 in / 9.7lbs
FSNX28-5CCT-BZ/WH	4	12.5 x 10.9 x 9.2 in / 11.2lbs
FSNX50-PC-4K-BZ	4	13.3 x 12.1 x 10.0 in / 14.7lbs
FSNX80-PC-4K-BZ	4	14.1 x 13.2 x 10.6 in / 19.7lbs

Photometric Specification

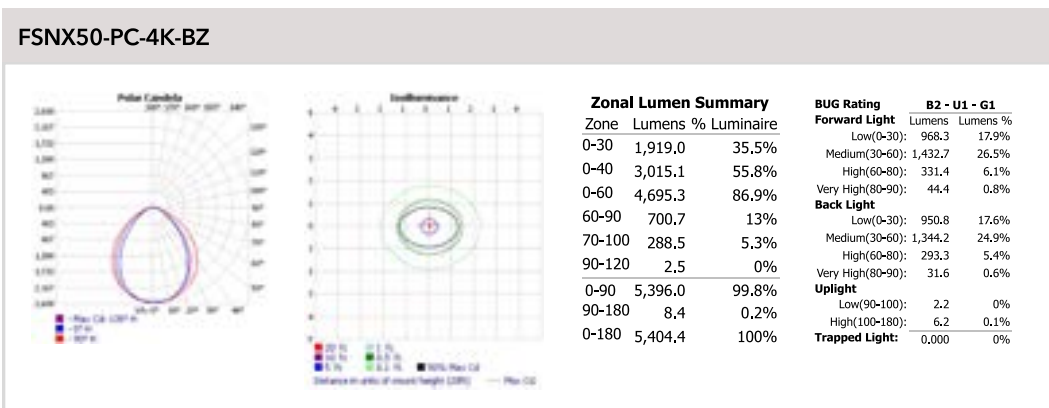

Note: Additional photometry available on request.

LED FLOOD LIGHTS

FLLS Series

Perfect blend of efficiency & value



- Die-cast Aluminum
- Easy Install
- 0-10V Dimming
- Wet Location Rated
- Integral Photocell
- Versatile Mounting

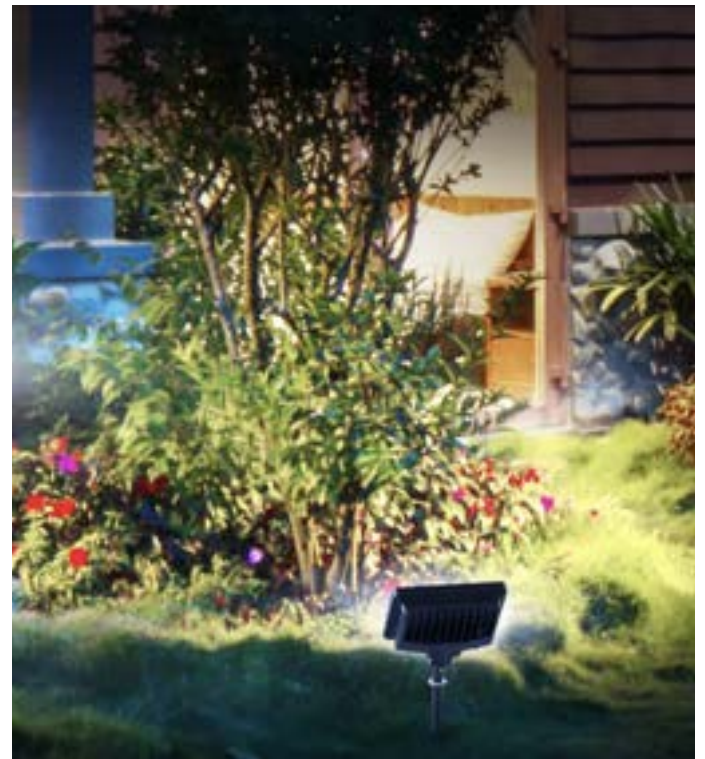

Product Features

Light Output: 2,100 - 21,000 Lumens

Wattage: 15 - 150 Watts

Replaces: Up to 200W MH

Efficacy: Up to 140 LPW

CCT Options: 4000K

CRI Options: 80 CRI

Finish Options: Bronze

Mounting: Knuckle Mount, Trunnion Mount

Housing: Die-cast Aluminum

Diffuser type: Clear Glass



Performance Specification

Model No.	Power (W)	Lumens (lm)	CCT (K)	LPW	Input Voltage	Mounting
FLLS-15W-40K-DV2-PC-CL-BZKM	15W	2,100	4000K	140	120-277V	Knuckle Mount
FLLS-25W-40K-DV2-PC-CL-BZKM	25W	3,200	4000K	124	120-277V	Knuckle Mount
FLLS-35W-40K-DV2-PC-CL-BZFM	35W	4,500	4000K	129	120-277V	Trunnion Mount
FLLS-60W-40K-DV2-PC-CL-BZFM	60W	8,000	4000K	133	120-277V	Trunnion Mount
FLLS-80W-40K-DV2-PC-CL-BZFM	80W	11,000	4000K	138	120-277V	Trunnion Mount
FLLS-100W-40K-DV2-PC-CL-BZFM	100W	14,000	4000K	140	120-277V	Trunnion Mount
FLLS-150W-40K-DV2-PC-CL-BZFM	150W	21,000	4000K	140	120-277V	Trunnion Mount

Product Dimensions

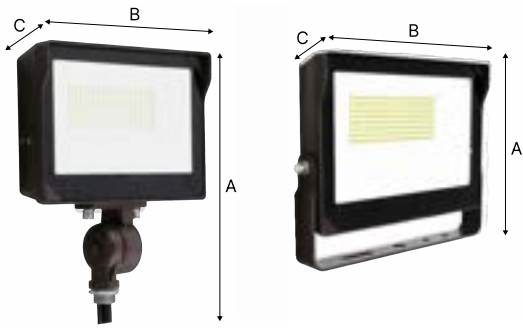

	FLLS-15W	FLLS-25W	FLLS-35W	FLLS-60W	FLLS-80W	FLLS-100W	FLLS-150W
A	7.7 in	7.7 in	7.2 in	8.7 in	10.2 in	10.2 in	11.5 in
B	5.8 in	5.8 in	6.3 in	7.7 in	8.8 in	8.8 in	9.7 in
C	2.0 in	2.0 in	2.2 in	2.2 in	2.7 in	2.7 in	2.8 in

Packaging Dimensions

Catalog Number	Master Pack Quantity	Dimensions
FLLS-15W-40K-DV2-PC-CL-BZKM	10	15.9 x 14.5 x 11.0 in / 23.6lbs
FLLS-25W-40K-DV2-PC-CL-BZKM	10	15.9 x 14.5 x 11.0 in / 23.6lbs
FLLS-35W-40K-DV2-PC-CL-BZFM	10	19.1 x 14.6 x 9.1 in / 28.2lbs
FLLS-60W-40K-DV2-PC-CL-BZFM	10	22.2 x 15.5 x 10.4 in / 42.3lbs
FLLS-80W-40K-DV2-PC-CL-BZFM	5	17.5 x 11.6 x 13.1 in / 35.3lbs
FLLS-100W-40K-DV2-PC-CL-BZFM	5	17.5 x 11.6 x 13.1 in / 35.3lbs
FLLS-150W-40K-DV2-PC-CL-BZFM	5	18.5 x 14.2 x 12.2 in / 47.3lbs

Photometric Specification

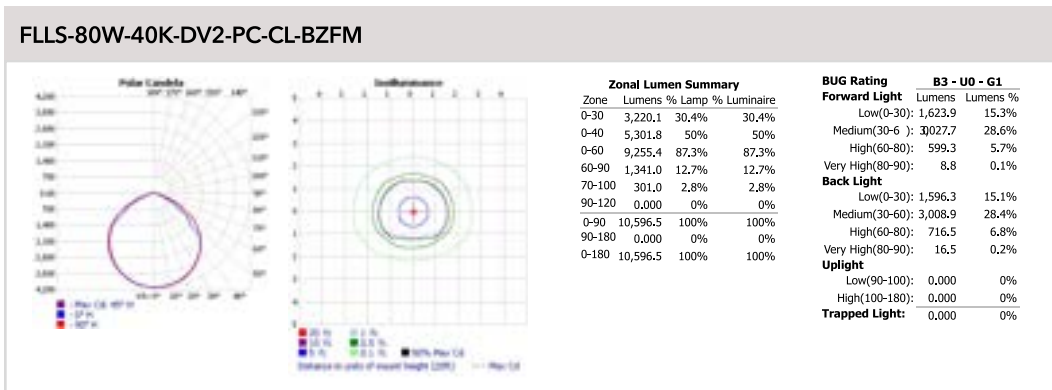

Note: Additional photometry available on request.

Accessories



FLLS-AM-KB-S
Knuckle Mount



FLLS-AM-L
Slip Fitter Mount



FLLS-FM
Flush Mount

LED FLOOD LIGHTS

FLLS Series - CCT & Wattage Selectable

Perfect blend of efficiency & value



- Die-cast Aluminum
- Easy Install
- 0-10V Dimming
- Wet Location Rated
- Integral Photocell
- Versatile Mounting



Product Features

Light Output: 2,100 - 21,750 Lumens

Wattage: 15 - 150 Watts

Replaces: Up to 200W MH

Efficacy: Up to 140 LPW

CCT Options: 3000K/4000K/5000K

CRI Options: 80 CRI

Finish Options: Bronze

Mounting: Knuckle Mount, Slip-Fitter Mount

Housing: Die-cast Aluminum

Diffuser type: Clear Glass



Performance Specification

Model No.	Power (W)	Lumens (lm)	CCT (K)	LPW	Input Voltage	Mounting
FLLS-15T35W-3CCT-DV2-PC-BZKM	15W	2,100	3000K	140	120-277V	Knuckle Mount
	25W	3,500	4000K			
	35W	4,900	5000K			
FLLS-40T80W-3CCT-DV2-PC-BZKM	40W	5,600	3000K	140	120-277V	Knuckle Mount
	60W	8,400	4000K			
	80W	11,200	5000K			
FLLS-100T150W-3CCT-DV2-PC-BZAM	100W	14,500	3000K	145	120-277V	Slip-Fitter Mount
	120W	17,400	4000K			
	150W	21,750	5000K			

Product Dimensions

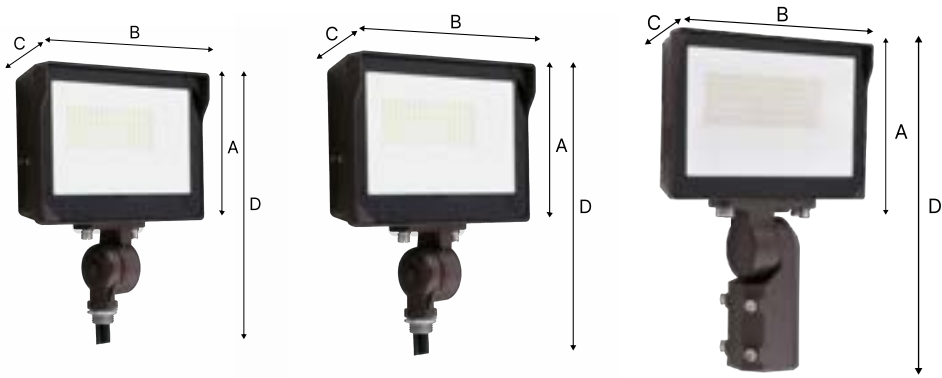

	FLLS-15T35W	FLLS-40T80W	FLLS-100T150W
A	5.2 in	6.4 in	11.4 in
B	7.2 in	8.7 in	8.2 in
C	2.2 in	2.2 in	2.8 in
D	8.6 in	9.8 in	15.1 in

Packaging Dimensions

Catalog Number	Master Pack Quantity	Dimensions
FLLS-15T35W-3CCT-DV2-PC-BZKM	10	18.3 x 14.5 x 11.8 in / 29.1lbs
FLLS-40T80W-3CCT-DV2-PC-BZKM	10	18.3 x 14.5 x 11.8 in / 29.1lbs
FLLS-100T150W-3CCT-DV2-PC-BZAM	5	19.4 x 17.5 x 14.2 in / 47.3lbs

Photometric Specification

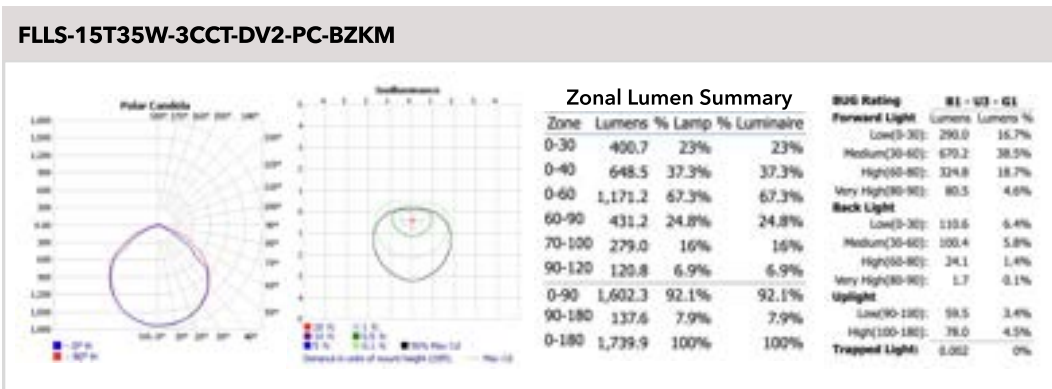

Note: Additional photometry available on request.

Accessories



FLLS-KM
Knuckle Mount



FLLS-AM
Slip Fitter Mount



FLLS-FM
Flush Mount

LED FLOOD LIGHTS

PWRF Series

Perfect blend of efficiency & value



- Die-cast Aluminum
- Easy Install
- 0-10V Dimming
- Wet Location Rated
- Integral Photocell



Product Features

Light Output: 2,000 - 5,000 Lumens

Wattage: 20 - 50 Watts

Replaces: Up to 120 MH

Efficacy: Up to 100 LPW

CCT Options: 4000K

CRI Options: 80 CRI

Finish Options: Bronze

Mounting: Knuckle Mount

Housing: Die-cast Aluminum

Diffuser type: Clear Glass



Performance Specification

Model No.	Power (W)	Lumens (lm)	CCT (K)	LPW	Input Voltage	Mounting
PWRF20-4K-BZ	20W	2,000	4000K	100	120-277V	Knuckle Mount
PWRF50-PC-4K-BZ	50W	5,000	4000K	100	120-277V	Knuckle Mount

Product Dimensions

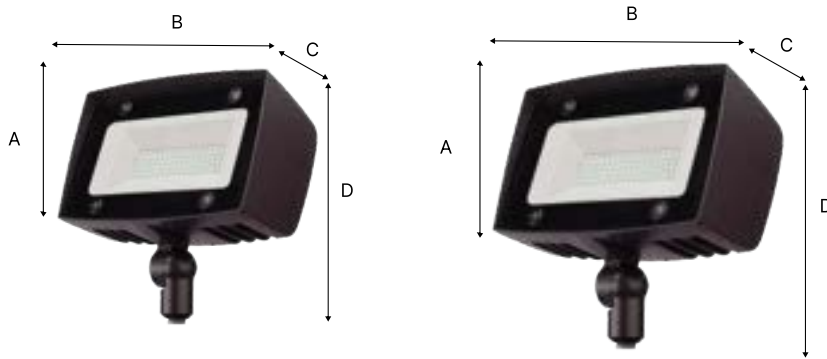

	PWRF20	PWRF50
A	5.1 in	6.2 in
B	7.7 in	10.0 in
C	4.1 in	4.7 in
D	8.8 in	10.0 in

Packaging Dimensions

Catalog Number	Master Pack Quantity	Dimensions
PWRF20-4K-BZ	4	15 x 19.25 x 10.91 in / 24.5lbs
PWRF50-PC-4K-BZ	4	15 x 21.22 x 13.11 in / 31.9lbs

Photometric Specification

PWRF20-4K-BZ

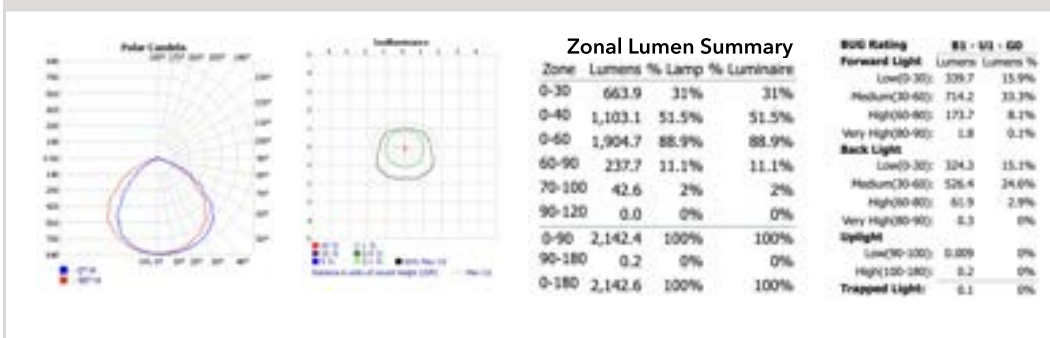

PWRF50-PC-4K-BZ

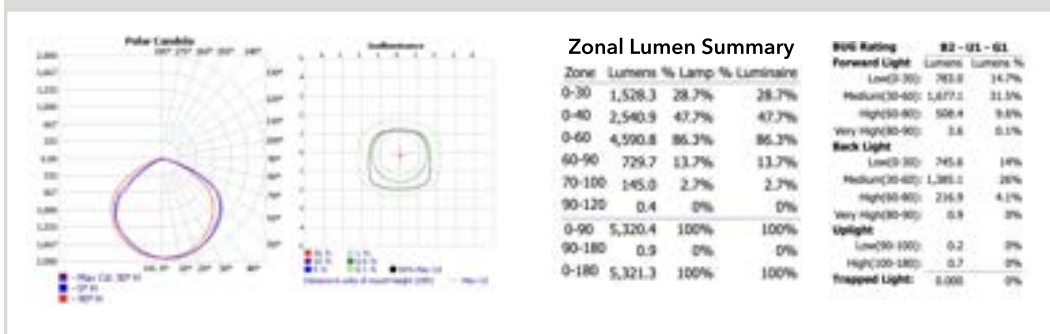

Note: Additional photometry available on request.

LED FLOOD LIGHTS

PWRFX Series

Perfect blend of efficiency & value



- Die-cast Aluminum
- Easy Install
- 0-10V Dimming
- Wet Location Rated
- Integral Photocell
- Versatile Mounting

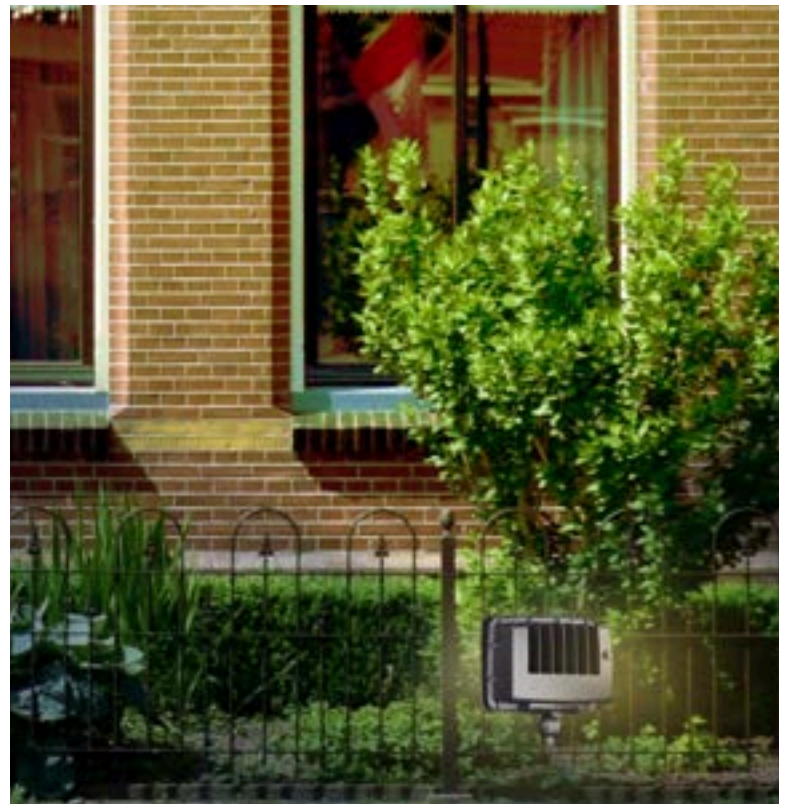

Product Features

Light Output: 6,000 - 14,000 Lumens

Wattage: 45 - 110 Watts

Replaces: Up to 120 MH

Efficacy: Up to 100 LPW

CCT Options: 4000K

CRI Options: 70 CRI

Finish Options: Bronze

Mounting: Knuckle Mount

Housing: Die-cast Aluminum

Diffuser type: Clear Glass



Performance Specification

Model No.	Power (W)	Lumens (lm)	CCT (K)	LPW	Input Voltage	Mounting
PWRFX45-PC-4K-BZ	45W	6,000	4000K	133	120-277V	Knuckle Mount
PWRFX70-PC-4K-BZ	70W	9,500	4000K	135	120-277V	Knuckle Mount
PWRFX110-PC-4K-BZ	110W	14,000	4000K	127	120-277V	Knuckle Mount

Product Dimensions

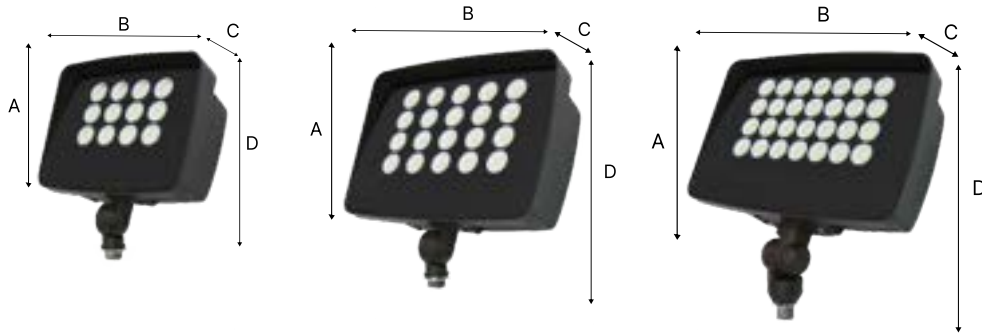

	PWRFX45	PWRFX70	PWRFX110
A	6.17 in	7.37 in	7.76 in
B	8.12 in	10.48 in	11.66 in
C	4.15 in	4.34 in	4.34 in
D	8.55 in	9.17 in	11.74 in

Packaging Dimensions

Catalog Number	Master Pack Quantity	Dimensions
PWRFX45-PC-4K-BZ	4	20.87 x 12.09 x 9.84 in / 22.7lbs
PWRFX70-PC-4K-BZ	2	12.91 x 12.52 x 11.02 in / 17.8lbs
PWRFX110-PC-4K-BZ	2	14.02 x 12.52 x 12.02 in / 22.0 lbs

Photometric Specification

PWRFX45-PC-4K-BZ

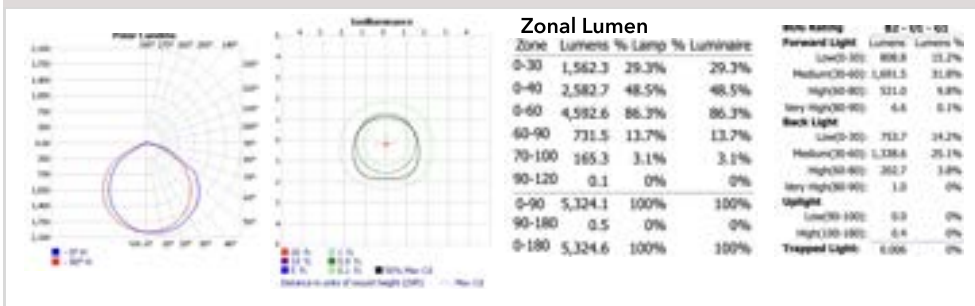

PWRFX70-PC-4K-BZ

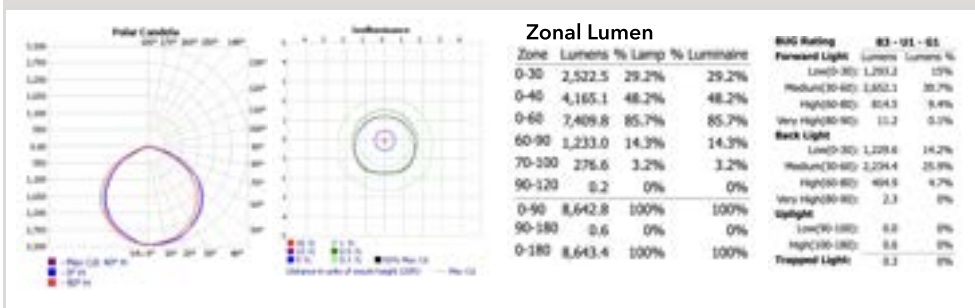

PWRFX110-PC-4K-BZ

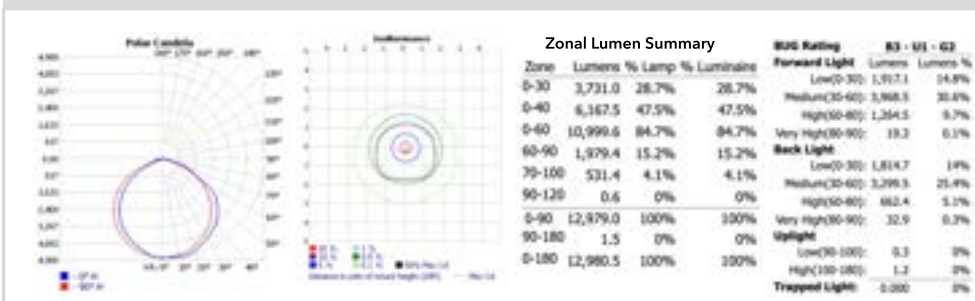

Note: Additional photometry available on request.

LED FLOOD AND SPOT LIGHTS

GRD Series

Perfect blend of efficiency & value



- Die-cast Aluminum
- Easy Install
- 0-10V Dimming
- Wet Location Rated
- Integral Photocell
- Versatile Mounting



Product Features

Light Output: 4,500 - 20,000 Lumens

Wattage: 32 - 150 Watts

Replaces: Up to 120 MH

Efficacy: Up to 140 LPW

CCT Options: 4000K

CRI Options: 70 CRI

Finish Options: Bronze

Mounting: Knuckle Mount, Direct Arm Mount

Housing: Die-cast Aluminum

Diffuser type: Clear Glass



Performance Specification

Model No.	Power (W)	Lumens (lm)	CCT (K)	LPW	Input Voltage	Mounting
GRD32-PC-4K-BZ	32W	4,500	4000K	139	120-277V	Slip Fitter, Direct Arm Mount
GRD64-PC-4K-BZ	64W	8,500	4000K	140	120-277V	Slip Fitter, Direct Arm Mount
GRD100-PC-4K-BZ	100W	14,000	4000K	133	120-277V	Slip Fitter, Direct Arm Mount
GRD150-PC-4K-BZ	150W	20,000	4000K	140	120-277V	Slip Fitter, Direct Arm Mount

Product Dimensions

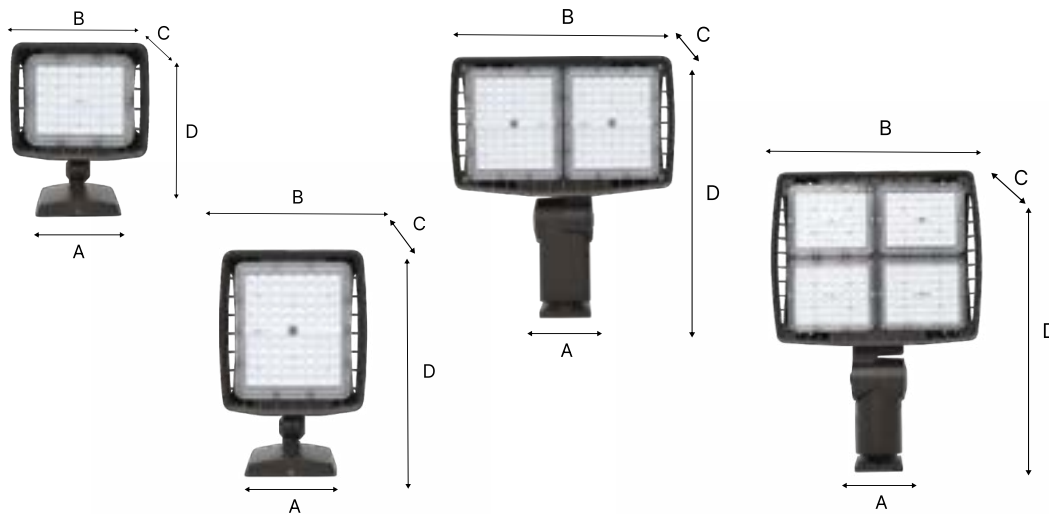

	GRD32	GRD64	GRD100	GRD150
A	5.35 in	5.35 in	6.00 in	6.00 in
B	7.54 in	7.45 in	8.64 in	14.15 in
C	2.62 in	2.68 in	3.62 in	3.62 in
D	9.07 in	11.07 in	15.48 in	19.15 in

Packaging Dimensions

Catalog Number	Master Pack Quantity	Dimensions
GRD32-PC-4K-BZ	4	7.4 x 9.35 x 5.75 in / 4.62lbs
GRD64-PC-4K-BZ	2	5.75 x 9.35 x 5.75 in / 5.94lbs
GRD100-PC-4K-BZ	2	15.87 x 5.77 x 15.87 in / 14.74lbs
GRD150-PC-4K-BZ	2	16.34 x 5.81 x 16.34 in / 1.4lbs

Photometric Specification

GRD100-PC-4K-BZ

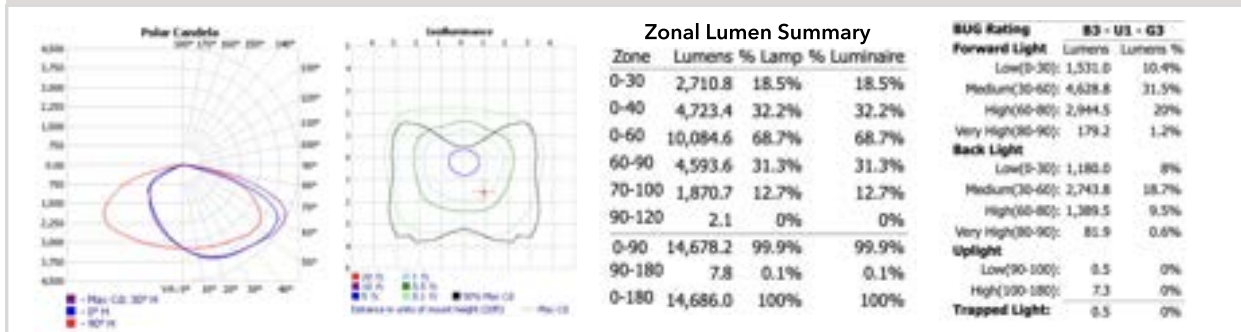

GRD150-PC-4K-BZ

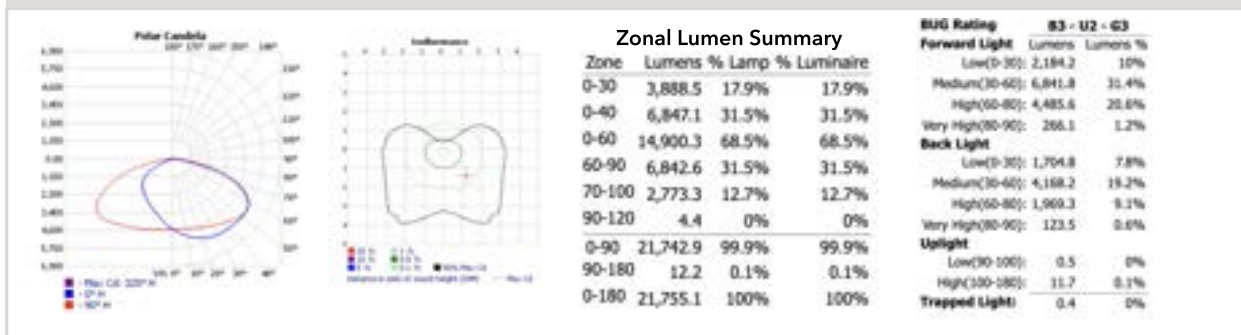

Note: Additional photometry available on request.

LED TWIN HEAD SECURITY LIGHTS

FusionX Duo Series

Aesthetic Security Light



- Die-cast Aluminum
- 120V
- Motion Sensor
- Integral Photocell
- Adjustable Heads



Product Features

Light Output: 3,200 - 6,000 Lumens

Wattage: 22 - 45 Watts

Replaces: Up to 75W MH

Efficacy: Up to 145 LPW

CCT Options: 4000K

CRI Options: 70 CRI

Finish Options: Bronze, White

Mounting: Wall Mount, Flood Mount, Eave Mount



Performance Specification

Model No.	Power (W)	Lumens (lm)	CCT (K)	LPW	Input Voltage	Finish
FSXD30-MS*-4K-BZ FSXD30-MS*-4K-WH	22W	3,200	4000K	145	120V	Bronze/White
FSXD30-PC-4K-BZ FSXD30-PC-4K-WH	22W	3,200	4000K	145	120V	Bronze/White
FSXD60-MS*-4K-BZ FSXD60-MS*-4K-WH	45W	6,000	4000K	133	120V	Bronze/White

*MS= Motion Activated Light

Note: Contact for custom configuration & specifications

Product Dimensions

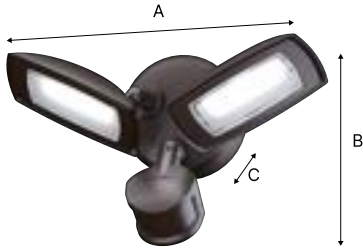

	FSXD30	FSXD60
A	12.7 in	15.3 in
B	8.0 in	8.0 in
C	1.7 in	1.7 in

Packaging Dimensions

Catalog Number	Master Pack Quantity	Dimensions
FSXD30-MS-4K-BZ/WH	4	19.5 x 13.6 x 10.1 in / 13.9lbs
FSXD30-PC-4K-BZ/WH	4	19.5 x 13.6 x 10.1 in / 13.0 lbs
FSXD60-MS-4K-BZ/WH	4	21.1 x 15.0 x 11.0 in / 16.4lbs

Photometric Specification

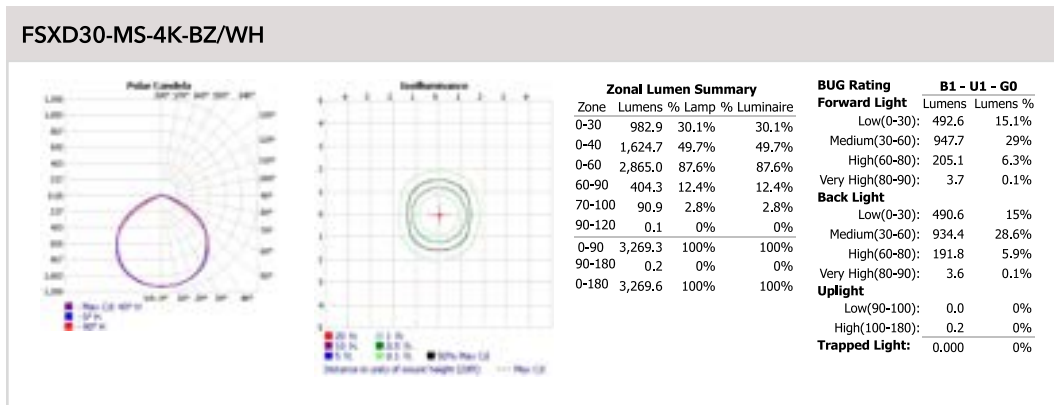

Note: Additional photometry available on request.

LED AREA LIGHTS

ARL Series

Next-gen performance at outstanding value.



- Die-cast Aluminum
- Easy Install
- 0-10V Dimming
- Wet Location Rated
- Type 3 Optics
- Integral Photocell

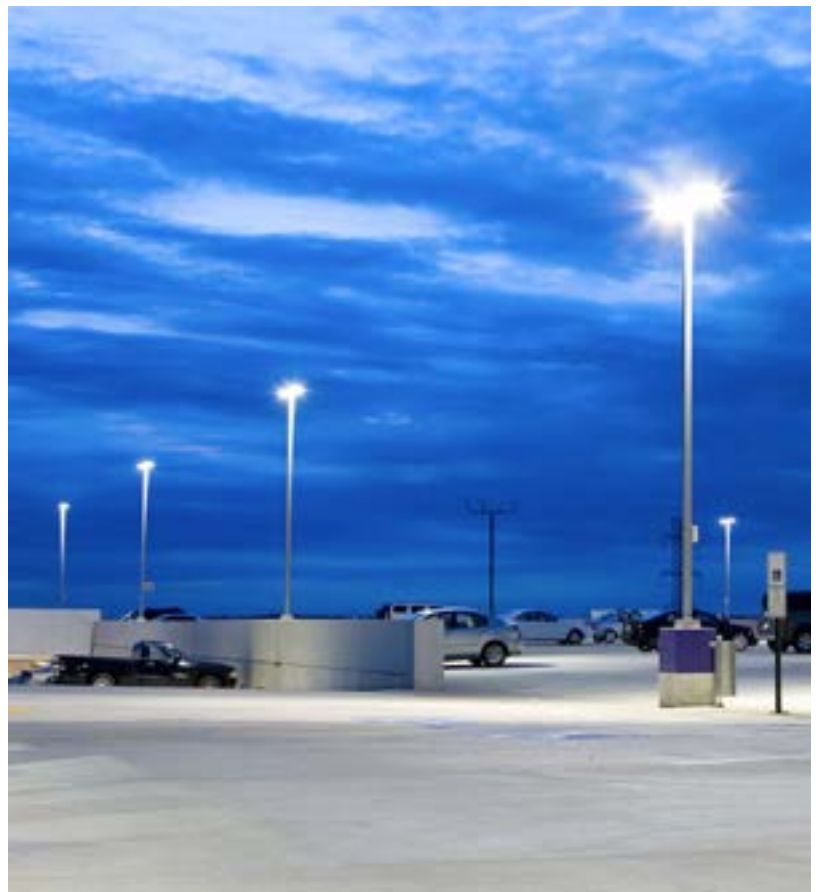

Product Features

Light Output: 14,500 - 43,500 Lumens

Wattage: 100 - 300 Watts

Replaces: Up to 250W MH

Efficacy: Up to 145 LPW

CCT Options: 4000K or 5000K

CRI Options: 70 CRI, 80 CRI

Finish Options: Bronze

Mounting Options: Direct Arm Mount, Universal Mount, Trunnion Mount, Yoke Mount, Slip-fitter Mount **(Sold Separately)**

Housing: Die-cast Aluminum

Diffusor type: Frosted Glass

Distribution Type: Type 3



Performance Specification

Model No.	Power (W)	Lumens (lm)	CCT (K)	LPW	Input Voltage	Finish
ARLS-100W-50K-DV2-PC-T3-BZ	100W	14,500	5000K	145	120-277V	Bronze
ARLM-150W-40K-DV2-PC-T3-BZ	150W	22,000	4000K	147	120-277V	Bronze
ARLL-200W-40K-DV2-PC-T3-BZ ARLL-200W-50K-DV2-PC-T3-BZ	200W	29,000	4000K or 5000K	145	120-277V	Bronze
ARLL-300W-50K-DV2-PC-T3-BZ	300W	43,500	5000K	145	120-277V	Bronze

Product Dimensions

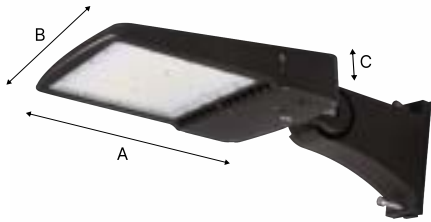

ARL-100W-300W	
A	12.1 in
B	10.7 in
C	2.7 in

Packaging Dimensions

Catalog Number	Master Pack Quantity	Dimensions
ARLS-100W-40K/50K-DV2-PC-T3-BZ	1	20.2 x 15.1 x 6.1 in / 8.2lbs
ARLM-150W-40K/50K-DV2-PC-T3-BZ	1	20.2 x 15.1 x 6.1 in / 8.2lbs
ARLL-200W-40K/50K-DV2-PC-T3-BZ	1	20.2 x 15.1 x 6.1 in / 8.2lbs
ARLL-300W-50K-DV2-PC-T3-BZ	1	25.9 x 5.6 x 15.9 in / 15.2lbs

Photometric Specification

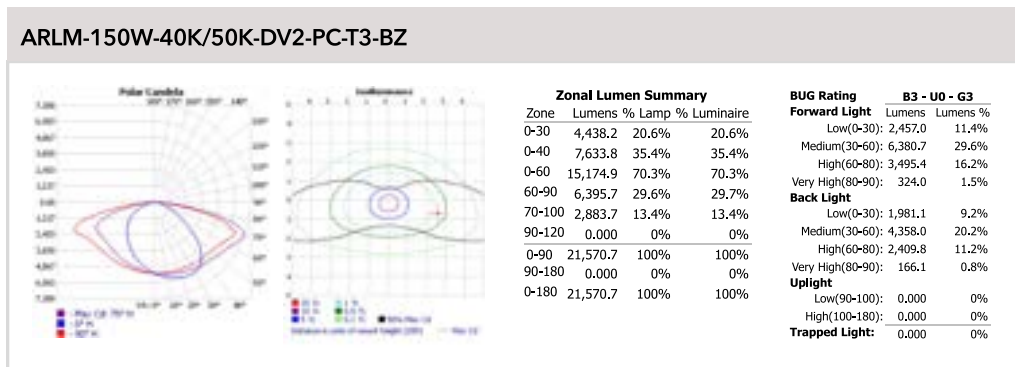

Note: Additional photometry available on request.

Accessories



Slip Fitter Mount
ARL-AM



Direct Arm Mount
ARL-DM



Universal Mount
ARL-ADM



Yoke Mount
ARL-YM



U-Bracket
ARL-FM-S
ARL-FM-L

LED AREA LIGHTS

ARL Series - 3 CCT Selectable

Next-gen performance at outstanding value.



- Optical Lens Swappable
- Die-cast Aluminum
- Easy Install
- 0-10V Dimming
- Wet Location Rated
- Photocell Receptacle
- White Color Selectable



Product Features

Light Output: 14,000 - 42,000 Lumens

Wattage: 100 - 300 Watts

Replaces: Up to 250W MH

Efficacy: Up to 145 LPW

CCT Selectable: 3000K/4000K/5000K

CRI Options: 80 CRI

Finish Options: Bronze

Mounting Options: Direct Arm Mount, Universal Mount, Trunnion Mount, Yoke Mount, Slip-fitter Mount
(Sold Separately)

Housing: Die-cast Aluminum

Diffusor type: Clear Glass

Distribution Type: Type 3 (assembled) and Type 5 (included in box)
Type 2 and Type 4 available (sold separately)



Performance Specification

Model No.	Power (W)	Lumens (lm)	CCT (K)	LPW	Input Voltage	Finish
ARL-100T150W-3CCT-DV2-PC-T3-BZ	100W 125W 150W	14,000 17,500 21,000	3000K 4000K 5000K	140	120-277V	Bronze
ARL-150T240W-3CCT-DV2-PC-T3-BZ ARL-150T240W-3CCT-DV3-PC-T3-BZ	150W 200W 240W	21,000 28,000 33,600	3000K 4000K 5000K	140	120-277V 277-480V	Bronze
ARL-200T300W-3CCT-DV2-PC-T3-BZ ARL-200T300W-3CCT-DV3-PC-T3-BZ	200W 240W 300W	28,000 33,600 42,000	3000K 4000K 5000K	140	120-277V 277-480V	Bronze

Note: Contact for custom configuration & specifications

Product Dimensions



	ARL-100-240W	ARL-200-300W
A	15.6 in	19.6 in
B	11.2 in	14.6 in
C	2.5 in	2.5 in

Packaging Dimensions

Catalog Number	Master Pack Quantity	Dimensions
ARL-100T150W-3CCT-DV2-PC-T3-BZ	1	21.1 X 5.6 X 13.1 in / 11.5lbs
ARL-150T240W-3CCT-DV2-PC-T3-BZ ARL-150T240W-3CCT-DV3-PC-T3-BZ	1	21.1 X 5.6 X 13.1 in / 11.5lbs
ARL-200T300W-3CCT-DV2-PC-T3-BZ ARL-200T300W-3CCT-DV3-PC-T3-BZ	1	27.8 X 5.6 X 15.9 in / 15.2 lbs

Photometric Specification

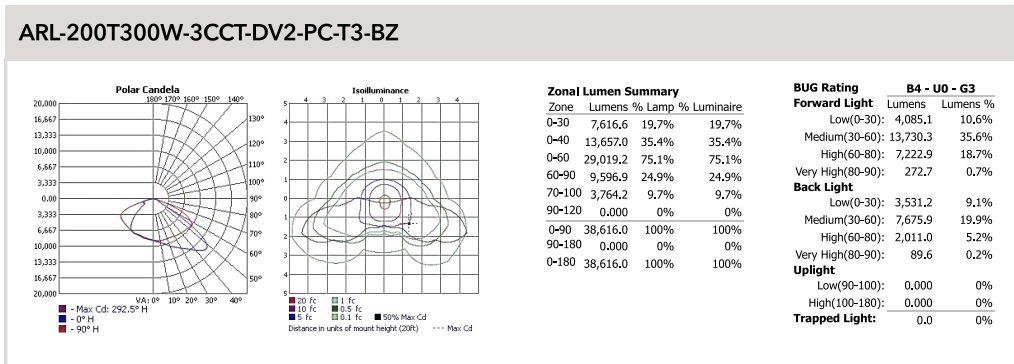

Note: Additional photometry available on request.

Accessories



Slip Fitter Mount
ARL- AM



Direct Arm Mount
ARL-DM



Universal Mount
ARL-ADM



Yoke Mount
ARLS-YM-U



U-Bracket
ARLS-FM-S
ARLS-FM-L



Glare Shield
ARL-GS-S
ARL-GS-L



Twist Lock Photocell
ARL-PC-DV2
ARL-PC-DV3

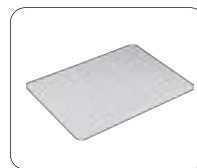

T2 / T4 Lenses
ARL-M-T2 / ARL-L-T2
ARL-M-T4 / ARL-L-T4

SQUARE STRAIGHT STEEL POLES

SSS Series

Embrace the Edge: Square Poles.

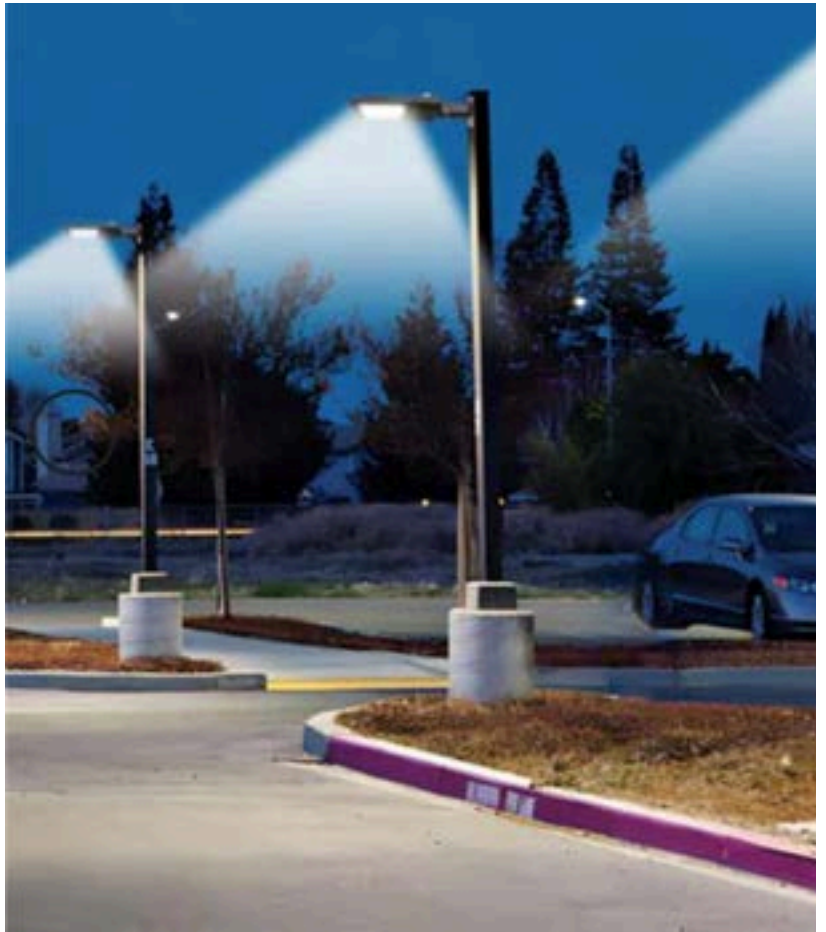

Product Features

Build Quality : ASTM A500 Grade C (IS 2062 E350) with minimum yield strength of 50,000 PSI.

Base Plate : Base plates constructed of high strength ASTM A36 steel with 36,000 PSI minimum yield strength.

Finish : Hot dip base coat with TGIC-free polyester powder coat bronze finish.

Anchor Bolts : Galvanized high strength ASTM A55 anchor bolts (set of 4) with 55,000 PSI minimum yield strength.

Performance Specification

Model #	Height	Gauge	Nominal Shaft Dimensions	Wall Thickness	Bolt Circle	Bolt Circle (Range)	Base Plate Square	Anchor Bolt Size	Pole Weight
SSS-4-G11-12-BZ	12ft	11	4"	0.119"	9"	8" - 11"	10.5"	3/4"x 30"x 4"	103 lbs
SSS-4-G11-15-BZ	15ft	11	4"	0.119"	9"	8" - 11"	10.5"	3/4"x 30"x 4"	127 lbs
SSS-4-G11-17-BZ	17ft	11	4"	0.119"	9"	8" - 11"	10.5"	3/4"x 30"x 4"	139 lbs
SSS-4-G11-20-BZ	20 ft	11	4"	0.119"	9"	8" - 11"	10.5"	3/4"x 30"x 4"	157 lbs
SSS-4-G11-25-BZ	25 ft	11	4"	0.119"	9"	8" - 11"	10.5"	3/4"x 30"x 4"	188 lbs
SSS-5-G11-30-BZ	30 ft	11	5"	0.119"	11"	10.5" - 12"	11"	1"x 36"x 4"	275 lbs
SSS-5-G07-30-BZ	30 ft	7	5"	0.179"	11"	10.5" - 12"	11"	1"x 36"x 4"	386 lbs

Anchor bolts : JB3044: Set of 4, 3/4"x 30" (included with 4" pole), JB3644: Set of 4, 1"x 36" (included with 5" pole)

ROUND STRAIGHT STEEL POLES

RSS Series

Embrace the Curves: Round Poles



Included Accessories:



Anchor Bolts



Template



Base Plate Cover



Hand Hole Cover



Product Features

Build Quality : ASTM A595 Grade A Carbon steel (Q235B) with minimum yield strength of 50,000 PSI.

Base Plate : Base Plates are carbon steel (ASTM A36).

Finish : Galvanized black polyester powder coat finish.

Anchor Bolts : Anchor bolts are partially galvanized per ASTM A153 specifications and furnished complete with 2 hex nuts and 2 plate washers.

Mounting : These poles are built with a tenon top. Single, twin, 180 and quad mounting brackets available (Sold Separately).

Performance Specification

Model #	Height	Gauge	Nominal Shaft Dimensions	Wall Thickness	Bolt Circle	Bolt Circle (Range)	Base Plate Square	Anchor Bolt Size	Pole Weight
RSS-4-10-20-BLK-GLV-T2	20 ft	10	4"	0.128"	9"	8" - 11"	10.5"	3/4"x 30"x 4"	132 lbs
RSS-5-11-20-BLK-GLV-T2	20 ft	11	5"	0.116"	11.5"	11" - 12"	11"	1"x 36"x 4"	152 lbs
RSS-5-11-22-BLK-GLV-T2	22 ft	11.5	5"	0.116"	11.5"	11" - 12"	11"	1"x 36"x 4"	165 lbs

Anchor bolts : JB3044: Set of 4, 3/4"x 30" (included with 4" pole), JB3644: Set of 4, 1"x 36" (included with 5" pole)

ROUND STRAIGHT DIRECT BURIAL POLES

RSS-DB Series

Embrace the Curves: Round Poles



Included Accessories:



Hand Hole Cover



Underground Wiring Access



Top Cap

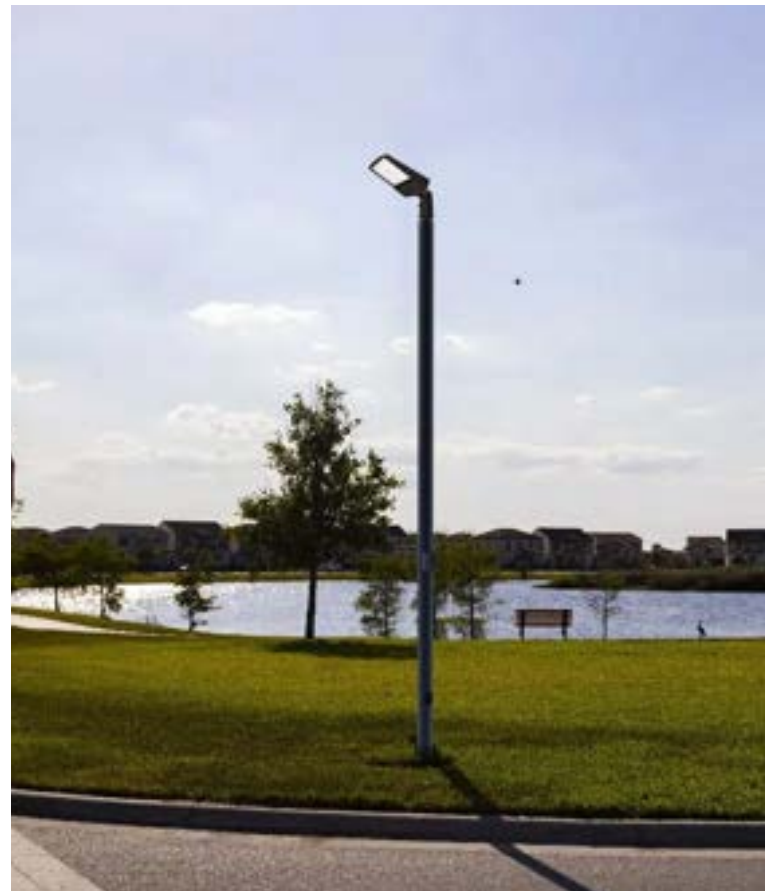

Product Features

Build Quality : Single piece welded shaft fabricated with ASTM-A 500 grade B carbon steel with a guaranteed minimum yield strength of 46,000 PSI.

Finish : Durable bronze polyester powder coat

Accessories : Pole includes reinforced cast-iron hand hole cover, with ground screw, underground wiring access, drill holes with plugs (2 sides) , and top cap.

Performance Specifications

Model #	Above Ground Height	Overall Height	Embedment Depth	Nominal Shaft Dimensions	Wall Thickness	Gauge	Pole Weight
RSS-DB-4-G11-20-BZ	20 ft	25 ft	5 ft	4"	0.120"	11	119 lbs
RSS-DB-4-G11-25-BZ	25 ft	30 ft	5 ft	4"	0.120"	11	137 lbs

Note: Contact for custom configuration & specifications

Mounting Accessories



**Wall Mount Bracket
Bronze
WMB**



**90° Wall
Mount Bracket
Bronze
WMB90**



**4" / 5" Vertical
Square Single Tenon
Bronze
PM-SSS-4-VT-S360
PM-SSS-5-VT-S360**



**4" Vertical
Round Single Tenon
Bronze
PM-RSS-4-RVT-S360**



**4" / 5" Horizontal
180° Twin Tenon
Bronze
PM-SSS-4-HT-D180
PM-SSS-5-HT-D180**



**4" / 5" Horizontal 90°
Dual tenon
Bronze
PM-SSS-4-HT-D090
PM-SSS-5-HT-D090**



**4" / 5" Horizontal
90° Tri Tenon
Bronze
PM-SSS-4-HT-T090
PM-SSS-5-HT-T090**



**4" / 5" Horizontal
90° Quad Tenon
Bronze
PM-SSS-4-HT-Q090
PM-SSS-5-HT-Q090**



**Vertical 180°
Twin Tenon
Bronze
PM-SSS-0-VT-D180**



**Vertical Tri Tenon, 30"
Bronze
PM-SSS-0-VT-T180-30**



**Vertical Tri Tenon, 54"
Bronze
PM-SSS-0-VT-T180-54**



**Vertical 90°
Quad Tenon
Bronze
PM-SSS-0-VT-Q090**

Mounting Accessories



**Dual 180° Bullhorn
Bronze**
PM-SSS-0-BH-D180

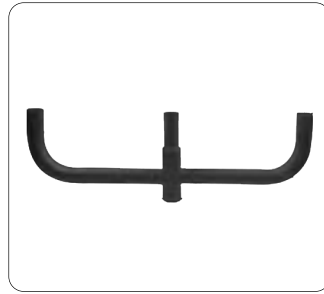

**Tri 180° Bullhorn
Bronze**
PM-SSS-0-BH-T180



**Tri 120° Bullhorn
Bronze**
PM-SSS-0-BH-T120



**Quad 90° Bullhorn
Bronze**
PM-SSS-0-BH-Q090



**Single Round
Horizontal Tenon
Black**
TA1-SINGL-BK-GLV



**90° Twin Round
Horizontal Tenon
Black**
TA1-TW90-BK-GLV

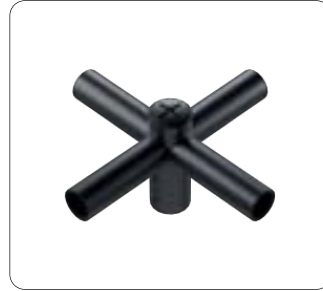

**90° Quad Round
Horizontal Tenon
Black**
TA1-QUAD-BK-GLV



SOLAR LIGHTING









SOLAR LIGHTING

SOLAR WALL PACKS

SPRW Series

Harness the Sun, Light the Night.



-  Solar Powered
-  Easy Install
-  Battery Powered
-  Remote Control
-  Motion Sensor
-  Dusk to Dawn



Product Features

Light Output: 1,500 - 4,000 Lumens

Wattage: 12 - 35 Watts

Replaces: Up to 100W MH

Efficacy: Up to 125 LPW

CCT Options: 5000K

CRI Options: 70 CRI

Finish Options: Bronze

Mounting: Wall Mount

Housing: Die-cast Aluminum

Diffuser type: Prismatic Lens

Operation: 5 modes of operation: 4 Hr mode, All-night mode, Energy-Saving mode, Motion-only mode, Occupancy mode



Performance Specification

Model No.	Power (W)	Lumens (lm)	CCT (K)	LPW	Battery Specs	Solar Panel
SPRW15-H-MS-5K-BZ	12W	1,500	5000K	125	3.2V 6000 mAh Li-ion	Integrated 5V/7W
SPRW45-H-MS-5K-BZ	35W	4,000	5000K	114	6.4V 6000 mAh Li-ion	Integrated 15V/10W

Note: Contact for custom configuration & specifications

Product Dimensions



	SPRW15-H-MS-5K-BZ
A	9.8 in
B	8.8 in
C	5.7 in

	SPRW45-H-MS-5K-BZ
A	16.5 in
B	13.9 in
C	8.3 in

Packaging Dimensions







Catalog Number	Master Pack Quantity	Dimensions
SPRW15-H-MS-5K-BZ	4	15.2 X 11.6 X 20.8 in / 20.3lbs
SPRW45-H-MS-5K-BZ	2	20.7 X 18.6 X 15.8 in / 23.4lbs

SOLAR AREA LIGHTS

SDAY Series

Illuminate Naturally, Shine Sustainably.



-  Solar Powered
-  Easy Install
-  Battery Powered
-  Remote Control
-  Motion Sensor
-  Dusk to Dawn



Product Features

Light Output: 4,500 Lumens

Wattage: 45 Watts

Replaces: Up to 50W MH

Efficacy: Up to 100 LPW

CCT Options: 5000K

CRI Options: 70 CRI

Finish Options: Bronze

Mounting: Pole Mount

Housing: Die-cast Aluminum

Diffusor type: Clear Lens

Operation: 5 modes of operation: 4 Hr mode, All night mode, Energy Saving Mode, Motion-only mode, Occupancy Mode



Performance Specification

Model No.	Power (W)	Lumens (lm)	CCT (K)	LPW	Battery Specs	Solar Panel
SDAY50-MS-5K-BZ	45W	4,500	5000K	100	9.6V/9000mAh	10.5W 15V 0.7A

Product Dimensions



	SDAY50-MS-5K-BK
A	20.7 in.
B	14.9 in.
C	3.6 in.

Packaging Dimensions







Catalog Number	Master Pack Quantity	Dimensions
SDAY50-MS-5K-BK	2	22.83 x 9.17 x 17.26 in

SOLAR AREA LIGHTS

SRON Series

Illuminate Naturally, Shine Sustainably.



-  Solar Powered
-  Easy Install
-  Battery Powered
-  Remote Control
-  Motion Sensor
-  Dusk to Dawn



Product Features

Light Output: 840 - 1,200 Lumens

Wattage: 7 - 10 Watts

Replaces: Up to 50W MH

Efficacy: Up to 120 LPW

CCT Options: 5000K

CRI Options: 70 CRI

Finish Options: Bronze

Mounting: Pole Mount

Housing: Die-cast Aluminum

Diffusor type: Clear Lens

Operation: 5 modes of operation: 3 Hr mode, 5 Hr mode, 8 Hr Mode, Motion-only mode, Auto IC timer mode



Performance Specification

Model No.	Power (W)	Lumens (lm)	CCT (K)	LPW	Battery Specs	Solar Panel
SRON8-5K-BZ	7W	840	5000K	120	3.2V 12000 mAh Li-ion	Integrated 6V/10W
SRON12-5K-BZ	10W	1,200	5000K	114	3.2V 24000 mAh Li-ion	Integrated 6V/20W

Note: Contact for custom configuration & specifications

Product Dimensions



	SRON8-5K-BZ
A	19.3 in
B	9.2 in
C	2.8 in

	SRON12-5K-BZ
A	22.0 in
B	10.4 in
C	2.8 in

Packaging Dimensions





Catalog Number	Master Pack Quantity	Dimensions
SRON8-5K-BZ	4	21.3 X 16.5 X 15.9 in / 39.5lbs
SRON12-5K-BZ	4	26.8 X 16.4 X 17.6 in / 56.2lbs

SOLAR FLOOD LIGHTS

SCOS Series

Radiate Brilliance, Powered by the Sun.



-  Solar Powered
-  Easy Install
-  Battery Powered
-  Remote Control



Product Features

Light Output: 600 - 1,200 Lumens

Wattage: 5 - 10 Watts

Replaces: Up to 50W MH

Efficacy: Up to 120 LPW

CCT Options: 5000K

CRI Options: 70 CRI

Finish Options: Bronze

Mounting: Pole Mount

Housing: Die-cast Aluminum

Diffusor type: Clear Lens

Operation: 5 modes of operation: 4 Hr mode, 6 Hr mode, 8 Hr Mode, 10 Hr mode, Auto IC timer mode



Performance Specification

Model No.	Power (W)	Lumens (lm)	CCT (K)	LPW	Battery Specs	Solar Panel
SCOS6-5K-BZ	5W	600	5000K	120	3.2V 18000 mAh Li-ion	17W
SCOS12-5K-BZ	10W	1,200	5000K	120	3.2V 30000 mAh Li-ion	24W

Note: Contact for custom configuration & specifications

Product Dimensions

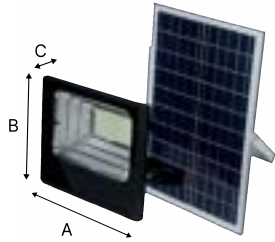

	SCOS6-5K-BZ		SCOS12-5K-BZ
A	9.4 in	A	12.9 in
B	7.5 in	B	10.9 in
C	1.7 in	C	2.2 in

Packaging Dimensions







Catalog Number	Master Pack Quantity	Dimensions
SCOS6-5K-BZ	4	16.6 X 16.2 X 16.1 in / 39.0lbs
SCOS12-5K-BZ	4	21.1 X 18.3 X 16.3 in / 57.6lbs

SOLAR BARN LIGHT

SNEB Series

Harvest the Sun, Illuminate the Night.



-  Solar Powered
-  Easy Install
-  Battery Powered
-  Remote Control
-  Motion Sensor
-  Dusk to Dawn



Product Features

Light Output: 4,000 Lumens

Wattage: 45 Watts

Replaces: Up to 50W MH

Efficacy: Up to 89 LPW

CCT Options: 5000K

CRI Options: 70 CRI

Finish Options: Bronze

Mounting: Wall Mount

Housing: Die-cast Aluminum

Diffusor type: Clear Prismatic Lens

Operation: 5 modes of operation: 4 Hr mode, All-night mode, Energy-Saving mode, Motion-only mode, Occupancy mode



Performance Specification

Model No.	Power (W)	Lumens (lm)	CCT (K)	LPW	Battery Specs	Solar Panel
SNEB50-MS-5K-BZ	45W	4,000	5000K	120	9.6V 6000 mAh Li-ion	10W/15V

Note: Contact for custom configuration & specifications

Product Dimensions



	SNEB50-MS-5K-BZ
A	7.6 in
B	11.0 in
C	4.8 in

Packaging Dimensions







Catalog Number	Master Pack Quantity	Dimensions
SNEB50-MS-5K-BZ	2	17.1 X 12.8 X 23.3 in / 25.2lbs

SOLAR WORKSHOP LIGHT

SQAD Series

Sun-Powered Precision: Illuminate Your Workspace.



-  Solar Powered
-  Easy Install
-  Battery Powered
-  Remote Control
-  Motion Sensor
-  Integral Photocell



Product Features

Light Output: 2,400 Lumens

Wattage: 24 Watts

Replaces: Up to 50W MH

Efficacy: Up to 100 LPW

CCT Options: 5000K

CRI Options: 70 CRI

Finish Options: Bronze

Mounting: Wall Mount,
Pole Mount

Housing: Die-cast Aluminum

Diffusor type: Frosted Lens

Operation: 5 modes of operation: 4 Hr mode,
All-night mode, Energy-Saving mode, Motion-
only mode, Occupancy mode



Performance Specification

Model No.	Power (W)	Lumens (lm)	CCT (K)	LPW	Battery Specs	Solar Panel
SQAD30-MS-5K-BZ	24W	2,400	5000K	100	6.4V 6000 mAh Li-ion	10W/10V

Note: Contact for custom configuration & specifications

Product Dimensions

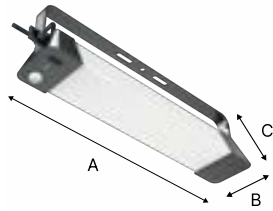

	SQAD30-MS-5K-BZ
A	16.4 in
B	3.1 in
C	4.5 in

Packaging Dimensions

Catalog Number	Master Pack Quantity	Dimensions
SQAD30-MS-5K-BZ	4	18.7 X 9.9 X 19.9 in / 16.2lbs



terraa



Landscape Lighting

By Eran Group

Brilliance with Every Step

Terra's low voltage technology ensures energy efficiency without compromising on performance or design. Transform your landscapes into captivating and enchanting spaces with subtle yet impactful illumination that highlights the beauty of your outdoor environment



3-TIER PATH LIGHT

Guides your way through enchanting gardens and captivating pathways.

● Black • LWP-P1BL3000KA2



- Easy Install
- Rugged metal construction
- Wet Rated
- Radiant halo glow (6 ft. dia)
- Heavy duty metal stake
- Ground mount

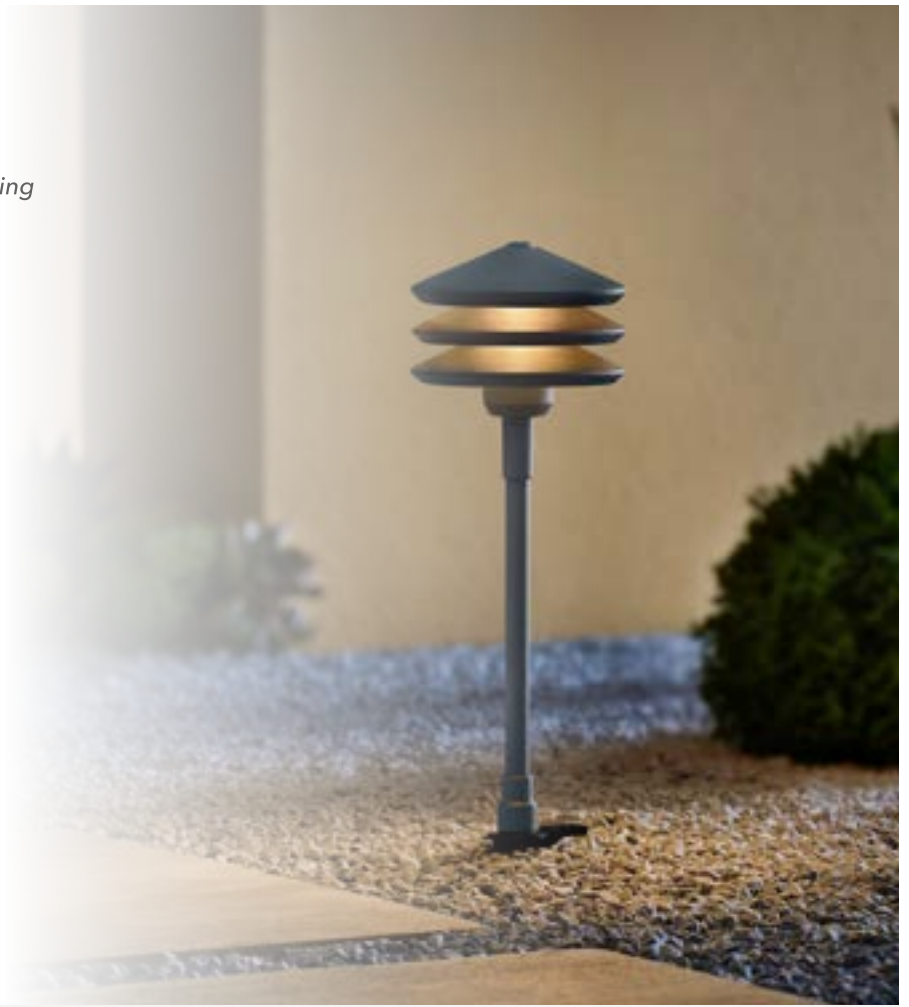

Product Details

Light Output: 100 Lumens

Wattage: 4.5 Watts

Efficacy: 23 LPW

Low Voltage: 12-15VAC

IP Rating: IP65

CCT Options: 30K

CRI Options: 80 CRI

Finish Options: Antique Brass, Black

Lens Type: Clear Polycarbonate Lens

Cord Length: 12" without barrel connector

Dimensions

5.4 in DIA
13.7 cm

14.6 in H
37.1 cm

6.5 in H
16.5 cm

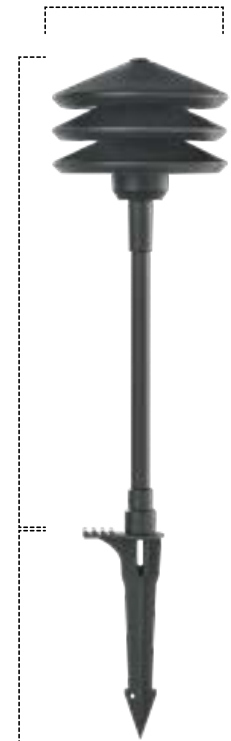

SINGLE TIER PATH LIGHT

Illuminating your pathways with a touch of elegance.

- Antique Brass • LWP-M1BR3000KA2
- Black • LWP-M1BL3000KA2
- Silver • LWP-M1AN3000KA2



- Easy Install
- Rugged metal construction
- Wet Rated
- Radiant halo glow (6 ft. dia)
- Heavy duty metal stake
- Ground mount



Product Details

Light Output: 100 Lumens

Wattage: 1.6 Watts

Efficacy: 63 LPW

Low Voltage: 12-15VAC

IP Rating: IP65

CCT Options: 30K

CRI Options: 80 CRI

Finish Options: Antique Brass, Black, Silver

Lens Type: Clear Polycarbonate Lens

Cord Length: 12" without barrel connector

Dimensions

8.2 in DIA
20.8 cm

18 in H
45.7 cm

6.5 in H
16.5 cm

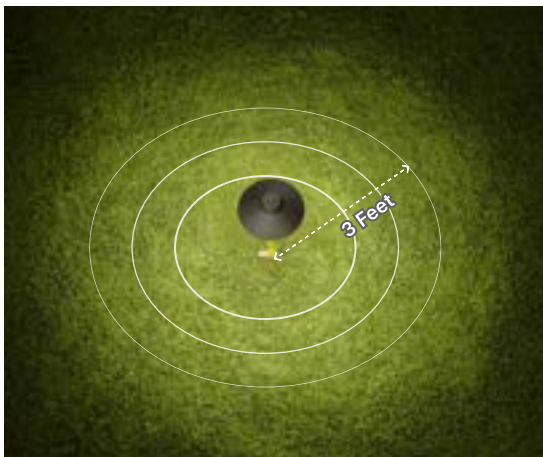
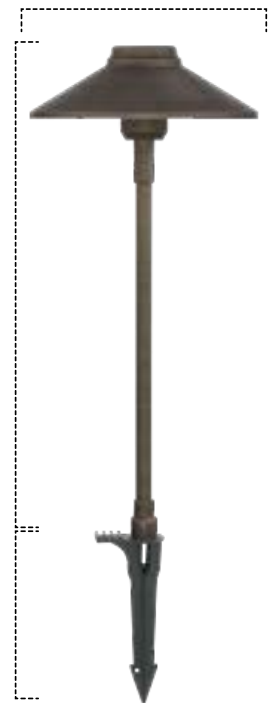

LED BOLLARDS

Transform your outdoor space into an extraordinary masterpiece.

● Black • LBO-N1BL3000K6B



- Easy Install
- Rugged metal construction
- Wet Rated
- Radiant halo glow (6 ft. dia)
- Heavy duty metal stake
- Ground mount



Product Details

Light Output: 100 Lumens

Wattage: 1.4 Watts

Efficacy: 72 LPW

Low Voltage: 12-15VAC

IP Rating: IP65

CCT Options: 30K

CRI Options: 80 CRI

Finish Options: Black

Lens Type: Frosted Lens

Cord Length: 12" without barrel connector

Dimensions

2.8 in DIA
7.1 cm

14.1 in H
35.8 cm

6.5 in H
16.5 cm

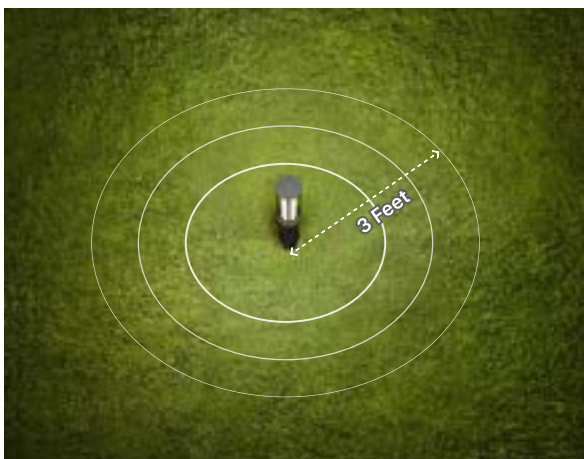
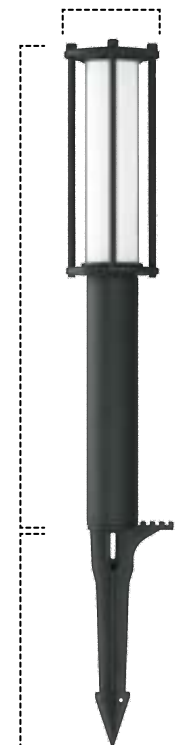

LED CAGED BOLLARDS

Modern design meets enchanting illumination.

- Antique Brass** • LBO-N1BRCL3000K
- Black** • LBO-N1BLCL3000K



- Easy Install
- Rugged metal construction
- Wet Rated
- Radiant halo glow (6 ft. dia)
- Heavy duty metal stake
- Ground mount



Product Details

Light Output: 100 Lumens

Wattage: 4.4 Watts

Efficacy: 23 LPW

Low Voltage: 12-15VAC

IP Rating: IP65

CCT Options: 30K

CRI Options: 80 CRI

Finish Options: Antique Brass, Black

Lens Type: Frosted Lens

Cord Length: 12" without barrel connector

Dimensions

2.8 in DIA
7.1 cm

14.1 in H
35.8 cm

6.5 in H
16.5 cm

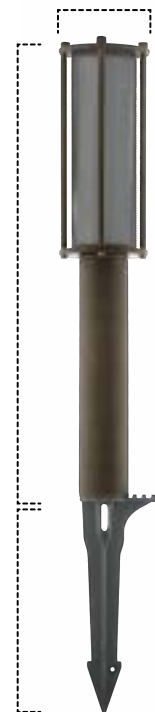
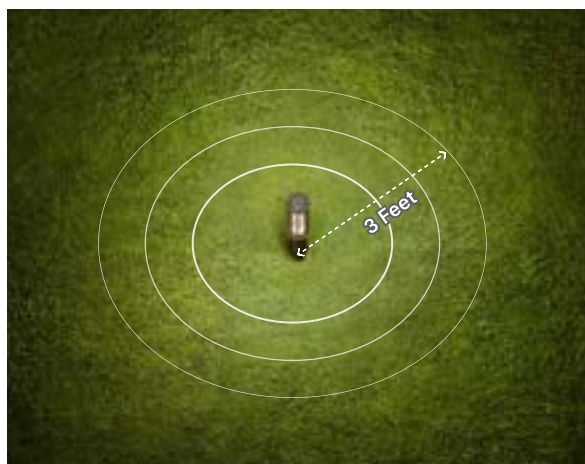







LED MINI BOLLARDS

Unleash a mesmerizing display of elegance where sleek sophistication meets radiant illumination.

- Antique Brass** • LWP-N1BR3000K5B
- Black** • LWP-N1BL3000K5B



-  Easy Install
-  Rugged metal construction
-  Wet Rated
-  Radiant halo glow (6 ft. dia)
-  Heavy duty metal stake
-  Ground mount



Product Details

Light Output: 100 Lumens

Wattage: 1.4 Watts

Efficacy: 72 LPW

Low Voltage: 12-15VAC

IP Rating: IP65

CCT Options: 30K

CRI Options: 80 CRI

Finish Options: Antique Brass, Black

Lens Type: Frosted Lens

Cord Length: 12" without barrel connector

Dimensions

2.8 in DIA
7.1 cm

10.7 in H
27.2 cm

6.5 in H
16.5 cm

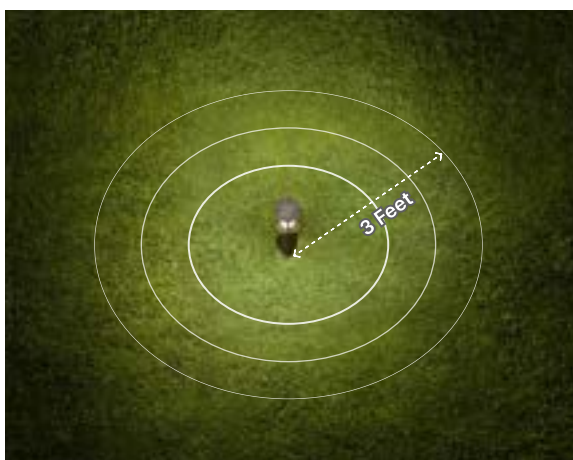

LED BOLLARDS

Expertly crafted to enhance your landscape's allure.

- Antique Brass** • LBO-NMB1BR3000K
- Black** • LBO-NMB1BR3000K
- Silver** • LBO-NMB1AN3000K



- Easy Install
- Rugged metal construction
- Wet Rated
- Radiant halo glow (6 ft. dia)
- Heavy duty metal stake
- Ground mount



Product Details

Light Output: 100 Lumens

Wattage: 2.5 Watts

Efficacy: 40 LPW

Low Voltage: 12-15VAC

IP Rating: IP65

CCT Options: 30K

CRI Options: 80 CRI

Finish Options: Antique Brass, Black, Silver

Lens Type: Frosted Lens

Cord Length: 12" without barrel connector

Dimensions

2.8 in DIA
7.1 cm

18.2 in H
46.2 cm

6.5 in H
16.5 cm

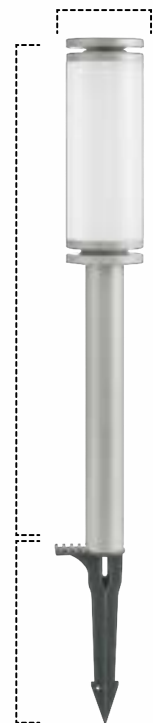







LED RGB BOLLARD

Where colors come alive - a spellbinding aura that turns your outdoor space into a captivating realm of light and wonder.

● Black • LBO-NMB1BLRGB



-  Easy Install
-  Rugged metal construction
-  Wet Rated
-  Radiant halo glow (6 ft. dia)
-  Heavy duty metal stake
-  Ground mount



Product Details

Light Output: 100 Lumens

Wattage: 2.5 Watts

Efficacy: 40 LPW

Low Voltage: 12-15VAC

IP Rating: IP65

CCT Options: RGB Color Options, Remote Control (included)

CRI Options: 80 CRI

Finish Options: Black

Lens Type: Clear Polycarbonate Lens

Cord Length: 12" without barrel connector

Dimensions

2.8 in DIA
7.1 cm

18.2 in H
46.2 cm

6.5 in H
16.5 cm



ADJUSTABLE SPOT LIGHT

Effortlessly illuminate your outdoor space with customizable brilliance.

- Antique Brass** • LST-NU4BR3000K
- Black** • LST-NU4BL3000K



- Easy Install
- Rugged Metal construction
- Wet Rated
- Ground mount
- Heavy duty metal stake
- Adjustable beam angle (40° (Min.) - 80° (Max.))



Product Details

Light Output: 400 Lumens

Wattage: 3.6 Watts

Efficacy: 111 LPW

Low Voltage: 12-15VAC

IP Rating: IP65

Beam Angle: 40° (Min.) - 80° (Max.)

CCT Options: 30K

CRI Options: 80 CRI

Finish Options: Antique Brass, Black

Lens Type: Clear Polycarbonate Lens

Cord Length: 12" without barrel connector

Dimensions

5.7 in D
14.5 cm

6.1 in H
15.5 cm

6.4 in H
16.2 cm









ROUND WELL/DECK LIGHT

Light the way forward.

Antique Brass • LDS-WR2BR3000K

Silver • LDS-WR2AN3000K



-  Easy Install
-  Rugged Metal construction
-  Wet Rated
-  Focused sideways illumination
-  Durable plastic stake
-  In-ground recessed mount



Product Details

Light Output: 150 Lumens

Wattage: 1.8 Watts

Efficacy: 83 LPW

Low Voltage: 12-15VAC

IP Rating: IP68

CCT Options: 30K

CRI Options: 80 CRI

Finish Options: Antique Brass, Silver

Cord Length: 48" without barrel connector

Lens Type: Frosted Lens, Silver model comes with 2-Way Lens adapter for focused illumination

Dimensions

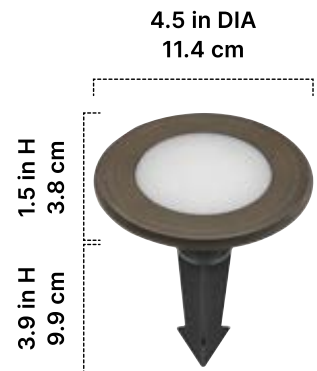

Only Silver model comes with 2-Way Lens adapter (cover) for focused illumination



SQUARE WELL/DECK LIGHT

Light the way forward

- Antique Brass • LDS-WS2BR3000K
- Silver • LDS-WS2AN3000K



- Easy Install
- Rugged Metal construction
- Wet Rated
- Focused sideways illumination
- Durable plastic stake
- In-ground recessed mount



Product Details

Light Output: 150 Lumens

Wattage: 1.8 Watts

Efficacy: 83 LPW

Low Voltage: 12-15VAC

IP Rating: IP68

CCT Options: 30K

CRI Options: 80 CRI

Finish Options: Antique Brass, Silver

Cord Length: 48" without barrel connector

Lens Type: Frosted Lens, Silver model comes with 2-Way Lens adapter for focused illumination

Dimensions

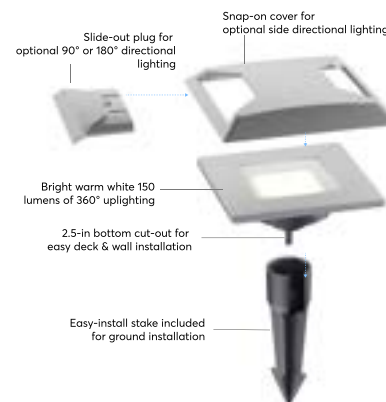
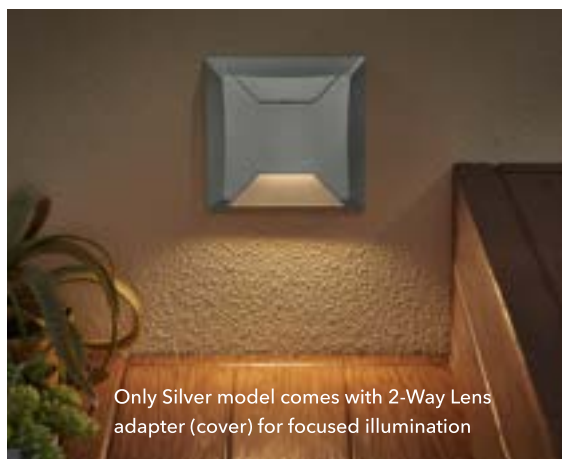

UP/DOWN DECK & STEP LIGHT

Casting a mesmerizing glow that guides your every stride

- **Antique Brass** • LDS-TR1BR3000K1 • LDS-TR1BR3000K2
- **Silver** • LDS-TR1BL3000K1 • LDS-TR1BL3000K2



- Easy Install
- Rugged Metal construction
- Wet Rated
- Vertical illumination
- Up/Down Light
- Wall and Deck mount



Product Details

Light Output: 100 Lumens

Wattage: 3.5 Watts

Efficacy: 29 LPW

Low Voltage: 12-15VAC

IP Rating: IP65

CCT Options: 30K

CRI Options: 80 CRI

Finish Options: Antique Brass, Black

Lens Type: Clear Polycarbonate Lens

Cord Length: 48" with barrel connector

Dimensions

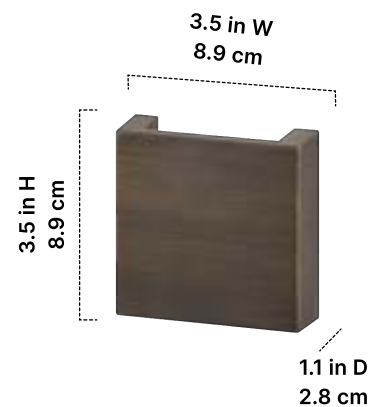
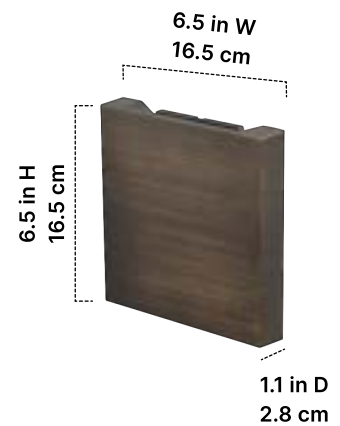

LED UP/DOWN DECK LIGHT

Experience a symphony of beauty and functionality as it elegantly lights your path, ensuring safety and enhancing the overall aesthetic appeal.



Nantucket Gray
LDS-G1WG3000K



Rocky Harbor Rustic Gray
LDS-G1WRH3000K



Heather Pebble Gray
LDS-G1WP3000K



Saddle Brown
LDS-G1WS3000K



Brazilian Walnut Brown
LDS-G1WG3000K

- Easy Install
- Rugged Metal construction
- Wet Rated
- Vertical illumination
- Up/Down Light
- Wall and Deck mount



Product Details

Light Output: 50 Lumens

Wattage: 1.2 Watts

Efficacy: 42 LPW

Low Voltage: 12-15VAC

IP Rating: IP65

CCT Options: 30K

CRI Options: 80 CRI

Lens Type: Clear Polycarbonate Lens

Cord Length: 48" with barrel connector

Finish Options: Finishes are designed to complement composite wood decking materials.

Dimensions

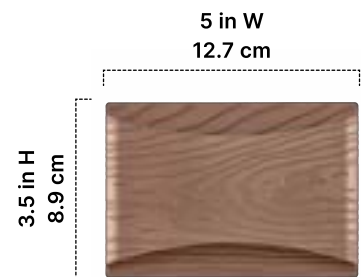



ALTITUDE

ALTITUDE

Ceiling Fans

By Eran Group

A Breath of Fresh Air

Altitude's designs have been propelled to the forefront of American fan and lighting by an uncompromising devotion to simplicity and utility. By fusing the highest technical sensibilities with the most appropriate material palette, Altitude is able to create unique, timeless designs with the power to transform any environment.



TRITOUR

Adding a refreshing breeze of contemporary elegance to any space with a simple pull.

Tritour 44", Tritour 52"

- Matte White** • 109LPC44MWHMWH / 109LPC52MWHMWH
- Matte Black** • 109LPC52MBKMBK
- Brushed Nickel** • 109LPC52BNSLV
- Black / Brown** • 109LPC52MBKDB



- Easy Install
- 30K/40K/50K
- ABS Blades
- Pull Chain Control
- AC Motor
- Indoor Rated



Product Details

Airflow (CFM): 44" : 2986 (High) - 1596 (Low)
52" : 4237 (High) - 2543 (Low)

Fan Control: Pull Chain Control

No. of speeds: 3 Speed

Light Type: Integrated LED

Lumens: 1000

LED Watts: 18W

CRI: 90

CCT: 30K, 40K, 50K

Indoor/Outdoor: Indoor Only

Motor Type /Size: AC / 153x12

Fan Size (in.)/Mounting Type: 44", 52"/ Downrod, Flat or Angled ceiling (18° max)

Housing: Matte Black, White, Brushed Nickel

Blades: Non-reversible, Matte Black/White, Dark Brown, or Silver

Lead Wire: 54" (to allow 48-inch downrod sold separately)

Distance from ceiling to bottom of the light kit once installed: 14.58"

Distance from Ceiling to bottom of blade once installed: 9.26"

Ceiling Fan Dimensions



Fan Size:	Blade Pitch:	Downrod included:	Recommended Room Size:
44"	12°	6 in	44" - 100 sq. ft. or smaller
52"			52" - Up to 350 sq. ft.

Recommended Downrod Length per Ceiling Height

For maximum comfort, fan should be installed approximately 8 ft from the floor.

Downrod Length		Ceiling Height
1.83 m	72 in	16 ft 4.88 m
1.52 m	60 in	15 ft 4.57 m
1.22 m	48 in	14 ft 4.27 m
91.44 cm	36 in	13 ft 3.96 m
60.96 cm	24 in	12 ft 3.66 m
45.72 cm	18 in	11 ft 3.35 m
30.48 cm	12 in	10 ft 3.05 m

Compatible with any unthreaded 1.00 in dia downrod

Application



GOSSAMER

Featuring a delicate and flowing design that embodies timeless elegance in every room it adorns.

Gossamer 52", Gossamer 60"

- Matte White** • 953L52MWH / 953L60MWH
- Matte Black** • 953L52MBK / 953L60MBK
- Brushed Nickel** • 953L52BNSLV / 953L60BNSLV



- Easy Install
- 30K/40K/50K
- ABS Blades
- Remote Control
- DC Motor
- Indoor Rated



Product Details

Airflow (CFM): 52" : 5663 (High) - 2275 (Low)
60" : 6100 (High) - 2421 (Low)

Fan Control: Remote Control

No. of speeds: 6 Speed

Light Type: Integrated LED

Lumens: 1000

LED Watts: 18W

CRI: 90

CCT: 30K, 40K, 50K

Indoor/Outdoor: Indoor Only

Motor Type /Size: DC / 156x8 | DC / 156x12

Fan Size (in.)/Mounting Type: 52", 60" / Downrod, Flat or Angled ceiling (18° max)

Housing: Matte Black, White, or Brushed Nickel

Blades: Non-reversible, Matte Black, White, or Silver

Lead Wire: 12" standard coming from motor with quick connector. Additional 44" extension lead wires with quick connectors included to allow for a 48" downrod (sold separately).

Distance from ceiling to bottom of the light kit once installed: 12.72"

Distance from Ceiling to bottom of blade once installed: 11.08"

Ceiling Fan Dimensions



Fan Size:	Blade Pitch:	Downrod Included:	Recommended Room Size:
52" 60"	13°	6 in	52" Up to 350 sq. ft. 60" Greater than 350 sq. ft.

Recommended Downrod Length per Ceiling Height

For maximum comfort, fan should be installed approximately 8 ft from the floor.

Downrod Length		Ceiling Height	
1.83 m	72 in	16 ft	4.88 m
1.52 m	60 in	15 ft	4.57 m
1.22 m	48 in	14 ft	4.27 m
91.44 cm	36 in	13 ft	3.96 m
60.96 cm	24 in	12 ft	3.66 m
45.72 cm	18 in	11 ft	3.35 m
30.48 cm	12 in	10 ft	3.05 m

Compatible with any unthreaded 1.00 in dia downrod

Application

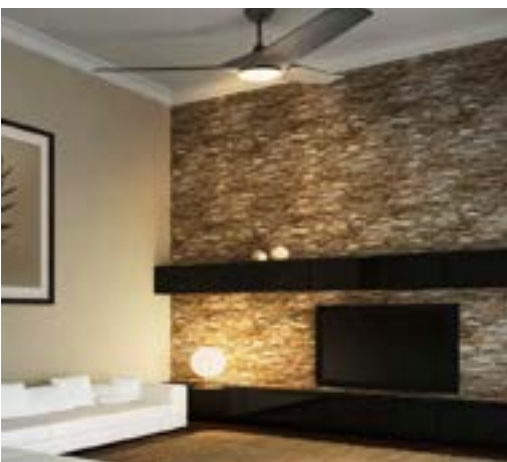







LARITZA

Tradition meets elegance with a captivating clean and transitional design.

Laritza 56"

-  **Matte White** • 108L56MWHMWH
-  **Matte Black** • 108L56MBKMBK
-  **Brushed Nickel / Driftwood** • 108L56BNDDW
-  **Black / Brown** • 108L56MBKDB



-  Easy Install
-  30K/40K/50K
-  ABS Blades
-  Remote Control
-  DC Motor
-  Outdoor Rated



Product Details

Airflow (CFM): 6016 (High) - 2565 (Low)

Fan Control: Remote Included

No. of speeds: 6 Speed

Light Type: Integrated LED

Lumens: 800

LED Watts: 18W

CRI: 90

CCT: 30K, 40K, 50K

Indoor/Outdoor: Indoor / Outdoor (Covered Patio)

Motor Type /Size: DC / 156x8

Fan Size (in.)/Mounting Type: 56"/ Downrod, Flat or Angled ceiling (18° max)

Housing: Matte Black, White, or Brushed Nickel

Blades: Non-reversible, Matte Black, Matte White, Faux Wood - Dark Brown or Dark Driftwood

Lead Wire: 12" Long with an additional 66" Extension wire to allow 72-inch downrod (sold separately)

Distance from ceiling to bottom of the light kit once installed: 13.03"

Distance from Ceiling to bottom of blade once installed: 10.01"

Ceiling Fan Dimensions



Fan Size: 56"	Blade Pitch: 12°	Downrod Included: 6 in	Recommended Room Size: Greater than 350 sq. ft
------------------	---------------------	---------------------------	---

Recommended Downrod Length per Ceiling Height

For maximum comfort, fan should be installed approximately 8 ft from the floor.

Downrod Length		Ceiling Height	
1.83 m	72 in	16 ft	4.88 m
1.52 m	60 in	15 ft	4.57 m
1.22 m	48 in	14 ft	4.27 m
91.44 cm	36 in	13 ft	3.96 m
60.96 cm	24 in	12 ft	3.66 m
45.72 cm	18 in	11 ft	3.35 m
30.48 cm	12 in	10 ft	3.05 m

Compatible with any unthreaded 1.00 in dia downrod

Application



LARITZA

Tradition meets elegance with a captivating clean and transitional design.

Laritza 56"

- Matte White** • 10856MWH
- Matte Black** • 10856MBK



- Easy Install
- DC Motor
- ABS Blades
- Remote Control
- Outdoor Rated



Product Details

Airflow (CFM): 6016 (High) - 2565 (Low)

Fan Control: Remote Included

No. of speeds: 6 Speed

Indoor/Outdoor: Indoor / Outdoor (Covered Patio)

Motor Type /Size: DC / 156x8

Fan Size (in.)/Mounting Type: 52", 60" / Downrod, Flat or Angled ceiling (18° max)

Housing: Matte Black/White

Blades: Non-reversible, Matte Black/White

Lead Wire: 12" Long with an additional 66" Extension wire to allow 72-inch downrod (sold separately)

Distance from ceiling to bottom of the light kit once installed: 11.46"

Distance from Ceiling to bottom of blade once installed: 10.01"

Ceiling Fan Dimensions



Fan Size:	Blade Pitch:	Downrod Included:	Recommended Room Size:
56"	12°	6 in	Greater than 350 sq. ft

Recommended Downrod Length per Ceiling Height

For maximum comfort, fan should be installed approximately 8 ft from the floor.

Downrod Length		Ceiling Height
1.83 m	72 in	16 ft 4.88 m
1.52 m	60 in	15 ft 4.27 m
1.22 m	48 in	14 ft 3.96 m
91.44 cm	36 in	12 ft 3.66 m
60.96 cm	24 in	11 ft 3.35 m
45.72 cm	18 in	10 ft 3.05 m

Compatible with any unthreaded 1.00 in dia downrod

Application



ARLETTE

Pinnacle of style and versatility with exquisite Italian-style, designed for residential and commercial spaces.

Arlette 60"

- **Matte White** • 131L60MWH
- **Matte Black** • 131L60MBK
- **Brushed Nickel** • 131L60BNSLV



- Easy Install
- 30K/40K/50K
- ABS Blades
- Remote Control
- DC Motor
- Outdoor Rated



Product Details

Airflow (CFM): 6382 (High) - 2505 (Low)

Fan Control: Remote Included

No. of speeds: 6 Speed

Light Type: Integrated LED

Lumens: 1200

LED Watts: 24W

CRI: 90

CCT: 30K, 40K, 50K

Indoor/Outdoor: Indoor / Outdoor (Covered Patio)

Motor Type /Size: DC / 156x8

Fan Size (in.)/Mounting Type: 60"/ Downrod, Flat or Angled ceiling (18° max)

Housing: Matte Black, White, or Brushed Nickel

Blades: Non-reversible, Matte Black, White, or Silver

Lead Wire: 12" Long with an additional 66" extension wire to allow 72" downrod (sold separately)

Distance from ceiling to bottom of the light kit once installed: 12.83"

Distance from Ceiling to bottom of blade once installed: 11.78"

Ceiling Fan Dimensions



Fan Size:	Blade Pitch:	Downrod Included:	Recommended Room Size:
60"	12°	6 in	Greater than 350 sq. ft.

Recommended Downrod Length per Ceiling Height

For maximum comfort, fan should be installed approximately 8 ft from the floor.

Downrod Length	Ceiling Height
1.83 m	72 in / 16 ft / 4.88 m
1.52 m	60 in / 15 ft / 4.57 m
1.22 m	48 in / 14 ft / 4.27 m
91.44 cm	36 in / 13 ft / 3.96 m
60.96 cm	24 in / 12 ft / 3.66 m
45.72 cm	18 in / 11 ft / 3.35 m
30.48 cm	12 in / 10 ft / 3.05 m

Compatible with any unthreaded 1.00 in dia downrod

Application



BOCA

Modern allure and undeniable functionality, a fan favorite among interior designers.

Boca 52" | Boca 60"

● Matte Black / Dark Driftwood • 102L52MBKDDW / 102L60MBKDDW

● Matte Black / Dark Brown • 102L52MBKDB / 102L60MBKDB

● Brushed Nickel / Dark Driftwood • 102L52BNDDW / 102L60BNDDW

● Brushed Nickel / Light Driftwood • 102L52BNLDW / 102L60BNLDW



Easy Install | 30K/40K/50K | ABS Blades

Remote Control | DC Motor | Outdoor Rated



Product Details

Airflow (CFM): 52" : 6600 (High) - 2500 (Low)
60" : 6837 (High) - 2740 (Low)

Fan Control: Remote Included

No. of speeds: 6 Speed

Light Type: Integrated LED

Lumens: 800

LED Watts: 18W

CRI: 90

CCT: 30K, 40K, 50K

Indoor/Outdoor: Indoor / Outdoor (Covered Patio)

Motor Type /Size: DC / 156x8 | DC / 156x12

Fan Size (in.)/Mounting Type: 52", 60" / Downrod mount only, Flat or Angled ceiling (18° max)

Housing: Matte Black, Brushed Nickel

Blades: Non-reversible, Dark Brown, Dark Driftwood, Light Driftwood

Lead Wire: 12" standard coming from motor with quick connector. Additional 54" extension lead wires with quick connectors included to allow for a 48" downrod (sold separately).

Distance from ceiling to bottom of the light kit once installed: 13.8"

Distance from Ceiling to bottom of blade once installed: 11.08"

Ceiling Fan Dimensions



Fan Size:	Blade Pitch:	Downrod Included:	Recommended Room Size:
52"	14°	6 in	52" Up to 350 sq. ft
60"			60" Greater than 350 sq. ft

Recommended Downrod Length per Ceiling Height

For maximum comfort, fan should be installed approximately 8 ft from the floor.

Downrod Length		Ceiling Height	
1.83 m	72 in	16 ft	4.88 m
1.52 m	60 in	15 ft	4.57 m
1.22 m	48 in	14 ft	4.27 m
91.44 cm	36 in	13 ft	3.96 m
60.96 cm	24 in	12 ft	3.66 m
45.72 cm	18 in	11 ft	3.35 m
30.48 cm	12 in	10 ft	3.05 m

Compatible with any unthreaded 1.00 in dia downrod

Application

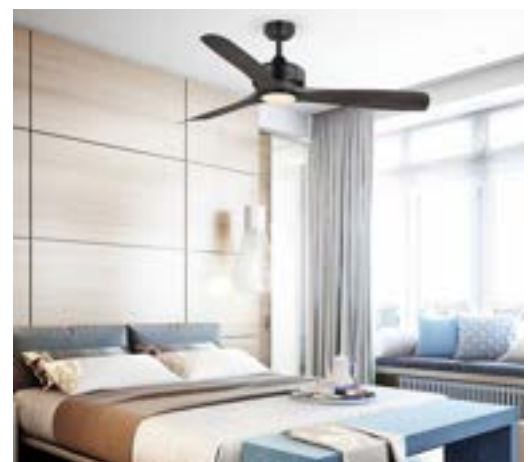

BOCA II

Featuring a delicate and flowing design that embodies timeless elegance in every room it adorns.

BOCA II 52"

● **Matte Black / Dark Brown** • BOCA2-52-MBK-DB-MTR

● **Matte Black** • BOCA2-52-MBK-MBK-MTR



Matter-Enabled
 2700K-6500K
 ABS Blades
 Remote Control
 DC Motor
 Outdoor Rated

matter
 Works with Apple Home
 works with alexa
 works with Google Home



Product Details

Airflow (CFM): 6600 (High) - 2500 (Low)

Fan Control: Remote Included

No. of speeds : 6 Speed

Light Type: Integrated LED

Lumens: 1200

LED Watts: 18W

CRI: 80

CCT: 27K / 30K / 35K / 40K / 50K / 65K

Indoor/Outdoor: Indoor / Outdoor (Covered Patio)

Motor Type : DC

Fan Size (in.)/Mounting Type: 52", Downrod, Flat or Angled ceiling (18° max)

Housing: Matte Black

Blades: Non-reversible, Matte Black, or Dark Brown

Lead Wire: 54" Long with an additional Extension wire to allow 48-inch downrod (sold separately)

Distance from ceiling to bottom of light kit once installed: 14.45"

Ceiling Fan Dimensions



Fan Size:	Blade Pitch:	Downrod Included:	Recommended Room Size:
52"	13°	6 in	Up to 350 sq. ft

Recommended Downrod Length per Ceiling Height

For maximum comfort, fan should be installed approximately 8 ft from the floor.

Downrod Length		Ceiling Height	
1.83 m	72 in	16 ft	4.88 m
1.52 m	60 in	15 ft	4.57 m
1.22 m	48 in	14 ft	4.27 m
91.44 cm	36 in	13 ft	3.96 m
60.96 cm	24 in	12 ft	3.66 m
45.72 cm	18 in	11 ft	3.35 m
30.48 cm	12 in	10 ft	3.05 m

Compatible with any unthreaded 1.00 in dia downrod

Application



SOLO

Sleek Design, Superior Comfort

SOLO 52"

○ Matte White • SOLO-52-MWH-MWH-BN

● Matte Black • SOLO-52-MBK-MBK-BN



2700K-6500K | ABS Blades

Remote Control | DC Motor | Outdoor Rated



Product Details

Airflow (CFM): 6000 (High) - 2300 (Low)

Fan Control: Remote Included

No. of speeds: 6 Speed

Light Type: Integrated LED

Lumens: 1200

LED Watts: 18W

CRI: 90

CCT: 27K / 30K / 35K / 40K / 50K / 65K

Indoor/Outdoor: Indoor / Outdoor (Covered Patio)

Motor Type : DC

Fan Size (in./Mounting Type): 52", Downrod, Flat or Angled ceiling (18° max)

Housing: Matte Black with Nickel accent ring or Matte White with White stainless accent ring

Blades: Non-reversible, Matte Black/White

Lead Wire: 54" Long with an additional Extension wire to allow 48-inch downrod (sold separately)

Distance from ceiling to bottom of light kit once installed: 16"

Ceiling Fan Dimensions



Fan Size: 52" | Blade Pitch: 13° | Downrod Included: 6 in | Recommended Room Size: Up to 350 sq. ft.

Recommended Downrod Length per Ceiling Height

For maximum comfort, fan should be installed approximately 8 ft from the floor.

Downrod Length		Ceiling Height	
1.83 m	72 in	16 ft	4.88 m
1.52 m	60 in	15 ft	4.57 m
1.22 m	48 in	14 ft	4.27 m
91.44 cm	36 in	13 ft	3.96 m
60.96 cm	24 in	12 ft	3.66 m
45.72 cm	18 in	11 ft	3.35 m
30.48 cm	12 in	10 ft	3.05 m

Compatible with any unthreaded 1.00 in dia downrod

Application



DRAGONFLY

Bold power meets a sleek, wing-like design.

Dragonfly 56"

● Matte Champagne / Oak / Cherry • DRGFY-56-MCP-RBODC-MTR

● Brushed Nickel / Oak / Cherry • DRGFY-56-BN-RBODC

● Matte Black / Oak / Cherry • DRGFY-56-MBK-RBODC



- Matter-Enabled
- 2700K-6500K
- ABS Blades
- Remote Control
- DC Motor
- Outdoor Rated



Product Details

Airflow (CFM): 5800 (High) - 2200 (Low)

Fan Control: Remote Included

No. of speeds: 6 Speed

Light Type: Integrated LED

Lumens: 1200

LED Watts: 18W

CRI: 90

CCT: 27K / 30K / 35K / 40K / 50K / 65K

Indoor/Outdoor: Indoor / Outdoor (Covered Patio)

Motor Type /Size: DC

Fan Size (in.)/Mounting Type: 56"/ Downrod, Flat or Angled ceiling (18° max)

Housing: Matte Champagne, Matte Black, or Brushed Nickel

Blades: Reversible, Blackened Oak or Dark Cherry

Lead Wire: 54" Long with an additional Extension wire to allow 48-inch downrod (sold separately)

Distance from ceiling to bottom of the light kit once installed: 12.72"

Ceiling Fan Dimensions



Fan Size:	Blade Pitch:	Downrod Included:	Recommended Room Size:
56"	13°	6 in	Greater than 350 sq. ft

Recommended Downrod Length per Ceiling Height

For maximum comfort, fan should be installed approximately 8 ft from the floor.

Downrod Length		Ceiling Height	
1.83 m	72 in	16 ft	4.88 m
1.52 m	60 in	15 ft	4.57 m
1.22 m	48 in	14 ft	4.27 m
91.44 cm	36 in	13 ft	3.96 m
60.96 cm	24 in	12 ft	3.66 m
45.72 cm	18 in	11 ft	3.35 m
30.48 cm	12 in	10 ft	3.05 m

Compatible with any unthreaded 1.00 in dia downrod

Application



TROY

Minimalist design, maximum performance.

Troy 60"

- **Matte Black** • TROY-60-MBK-MBK-CCT
- **Matte White** • TROY-60-MWH-MWH-CCT



- Remote Control
- 2700K-6500K
- ABS Blades
- DC Motor
- Outdoor Rated



Product Details

Airflow (CFM): 6600 (High) - 4400 (Low)

Fan Control: Remote Included

No. of speeds: 6 Speed

Light Type: Integrated LED

Lumens: 1000

LED Watts: 18W

CRI: 90

CCT: 27K / 30K / 35K / 40K / 50K / 65K

Indoor/Outdoor: Indoor / Outdoor (Covered Patio)

Motor Type /Size: DC

Fan Size (in.)/Mounting Type: 60"/ Downrod, Flat or Angled ceiling (18° max)

Housing: Matte Black, Matte White

Blades: Non-reversible, Matte Black, White

Lead Wire: 54" Long with an additional Extension wire to allow 48-inch downrod (sold separately)

Distance from ceiling to bottom of the light kit once installed: 12.72"

Ceiling Fan Dimensions



Fan Size: 60"	Blade Pitch: 13°	Downrod Included: 6 in	Recommended Room Size: Greater than 350 sq. ft
------------------	---------------------	---------------------------	---

Recommended Downrod Length per Ceiling Height

For maximum comfort, fan should be installed approximately 8 ft from the floor.

Downrod Length		Ceiling Height	
1.83 m	72 in	16 ft	4.88 m
1.52 m	60 in	15 ft	4.57 m
1.22 m	48 in	14 ft	4.27 m
91.44 cm	36 in	13 ft	3.96 m
60.96 cm	24 in	12 ft	3.66 m
45.72 cm	18 in	11 ft	3.35 m
30.48 cm	12 in	10 ft	3.05 m

Compatible with any unthreaded 1.00 in dia downrod

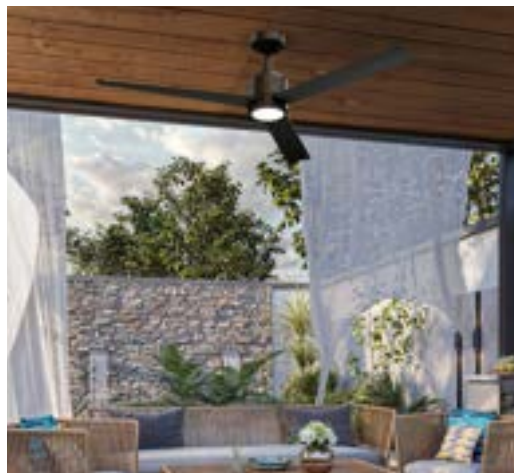

Application



SKYLARK

A statement in motion – modern, quiet, and powerful.

Skylark 52"

-  **Matte Champagne / White** • SKYL-52-MCP-MWH-MTR
-  **Matte Black / Dark Brown** • SKYL-52-MBK-DB-MTR
-  **Matte Champagne / Dark Brown** • SKYL-52-MCP-DB-MTR
-  **Brushed Nickel / Black** • SKYL-52-BN-MBK-MTR



 Matter-Enabled

 ABS Blades

 Remote Control

 DC Motor

 Outdoor Rated

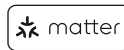

Product Details

Airflow (CFM): 5400 (High) -2000 (Low)

Fan Control: Remote Included

No. of speeds: 6 Speed

Indoor/Outdoor: Indoor / Outdoor (Covered Patio)

Motor Type /Size: DC

Fan Size (in.)/Mounting Type: 52"/ Downrod, Flat or Angled ceiling (18° max)

Housing: Matte Champagne, Matte Black, or Brushed Nickel

Blades: Non-reversible, Matte Black, White or Dark Brown

Lead Wire: 54" Long with an additional Extension wire to allow 48-inch downrod (sold separately)

Distance from ceiling to bottom of light kit once installed: 13.8"

Ceiling Fan Dimensions



Fan Size:	Blade Pitch:	Downrod Included:	Recommended Room Size:
52"	13°	6 in	Up to 350 sq. ft.

Recommended Downrod Length per Ceiling Height

For maximum comfort, fan should be installed approximately 8 ft from the floor.

Downrod Length		Ceiling Height	
1.83 m	72 in	16 ft	4.88 m
1.52 m	60 in	15 ft	4.57 m
1.22 m	48 in	14 ft	4.27 m
91.44 cm	36 in	13 ft	3.96 m
60.96 cm	24 in	12 ft	3.66 m
45.72 cm	18 in	11 ft	3.35 m
30.48 cm	12 in	10 ft	3.05 m

Compatible with any unthreaded 1.00 in dia downrod

Application



MOXY

Radiant uplighting and a sleek, transitional design.

Moxy 52"

● **Matte Black** • SPHMO-52-MBK-MBK-MBK-MTR



Dimmable /
 2700K-6500K /
 ABS Blades /
 Fully Controllable Uplight & Downlight

Remote Control /
 DC Motor /
 Outdoor Rated



Product Details

Airflow (CFM): 5330 (High) - 1837 (Low)

Fan Control: Remote Included

No. of speeds: 6 Speed

Light Type: Integrated LED

Lumens: 1000 Downlight
350 Uplight

LED Watts: 18W

CRI: 90

CCT: 27K / 30K / 35K / 40K / 50K / 65K

Indoor/Outdoor: Indoor / Outdoor (Covered Patio)

Motor Type /Size: DC

Fan Size (in.)/Mounting Type: 52"/ Downrod, Flat or Angled ceiling (18° max)

Housing: Matte Black housing with Matte Black cage

Blades: Non-reversible, Matte Black

Lead Wire: 54" Long

Distance from ceiling to bottom of the light kit once installed: 13.8"

Ceiling Fan Dimensions

Fan Size	Blade Pitch:	Mounting Type	Recommended Room Size:
52"	13°	Hugger Fan	Up to 350 sq. ft

Application



BANYAN

A modern touch of sophistication to your small spaces with the stylish and eye-catching rattan design.

Banyan 52"

○ Matte White • SPHBN-52-MWH-MWH-NRT-MTR



Dimmable | 2700K-6500K | ABS Blades | Fully Controllable Uplight & Downlight

Remote Control | DC Motor | Outdoor Rated



Product Details

Airflow (CFM): 5330 (High) - 1837 (Low)

Fan Control: Remote Included

No. of speeds: 6 Speed

Light Type: Integrated LED

Lumens: 1000 Downlight
350 Uplight

LED Watts: 18W

CRI: 90

CCT: 27K / 30K / 35K / 40K / 50K / 65K

Indoor/Outdoor: Indoor / Outdoor (Covered Patio)

Motor Type / Size: DC

Fan Size (in.)/Mounting Type: 52"/ Downrod, Flat or Angled ceiling (18° max)

Housing: Matte White with Natural Rattan Cage

Blades: Non-reversible, Matte White

Lead Wire: 54" Long

Distance from ceiling to bottom of the light kit once installed: 13.8"

Ceiling Fan Dimensions

Fan Size	Blade Pitch	Mounting Type	Recommended Room Size:
52"	13°	Hugger Fan	Up to 350 sq. ft

Application



MIGHTY CONDOR

Graceful power and flowing blades add a striking, modern touch.

Mighty Condor 60"

● **Matte Black / Dark Brown** • MCOND-60-MBK-DB-MTR

● **Matte Black** • MCOND-60-MBK-MBK-MTR

○ **Matte White** • MCOND-60-MWH-MWH-CCT-MTR



Dimmable / 2700K-6500K / ABS Blades

Remote Control / DC Motor / Outdoor Rated



Product Details

Airflow (CFM): 6500 (High) - 3500 (Low)

Fan Control: Remote Included

No. of speeds: 6 Speed

Light Type: Integrated LED

Lumens: 1500

LED Watts: 13W

CRI: 90

CCT: 27K / 30K / 35K / 40K / 50K / 65K

Indoor/Outdoor: Indoor / Outdoor (Covered Patio)

Motor Type /Size: DC

Fan Size (in.)/Mounting Type: 60"/ Downrod, Flat or Angled ceiling (18° max)

Housing: Matte Black, Matte White

Blades: Non-reversible, Dark Brown, Black, White

Lead Wire: 54" Long with an additional Extension wire to allow 48-inch downrod (sold separately)

Distance from ceiling to bottom of light kit once installed: 12.72"

Ceiling Fan Dimensions



Fan Size:	Blade Pitch:	Downrod Included:	Recommended Room Size:
60"	13°	6 in	Greater than 350 sq. ft.

Recommended Downrod Length per Ceiling Height

For maximum comfort, fan should be installed approximately 8 ft from the floor.

Downrod Length		Ceiling Height	
1.83 m	72 in	16 ft	4.88 m
1.52 m	60 in	15 ft	4.57 m
1.22 m	48 in	14 ft	4.27 m
91.44 cm	36 in	13 ft	3.96 m
60.96 cm	24 in	12 ft	3.66 m
45.72 cm	18 in	11 ft	3.35 m
30.48 cm	12 in	10 ft	3.05 m

Compatible with any unthreaded 1.00 in dia downrod

Application



TRINITY

Effortless airflow meets contemporary design

Trinity 52"

● **Matte Black** • TRIN-52-MBK-MBK-BKN-MDL-MTR



- Matter-Enabled
- 2700K-6500K
- ABS Blades
- Remote Control
- DC Motor
- Outdoor Rated



Product Details

Airflow (CFM): 5500 (High) - 2300 (Low)

Fan Control: Remote Included

No. of speeds: 6 Speed

Light Type: Integrated LED

Lumens: 1000

LED Watts: 18W

CRI: 90

CCT: 27K / 30K / 35K / 40K / 50K / 65K

Indoor/Outdoor: Indoor / Outdoor (Covered Patio)

Motor Type /Size: DC

Fan Size (in.)/Mounting Type: 52"/ Downrod, Flat or Angled ceiling (18° max)

Housing: Matte Black

Blades: Non-reversible, Matte Black

Lead Wire: 54" Long with an additional Extension wire to allow 48-inch downrod (sold separately)

Distance from ceiling to bottom of the light kit once installed: 13.8"

Light Kit: Light kit removable. Decorative cover included in box.

Ceiling Fan Dimensions



Fan Size: 52"	Blade Pitch: 13°	Downrod Included: 6 in	Recommended Room Size: Up to 350 sq. ft
------------------	---------------------	---------------------------	--

Recommended Downrod Length per Ceiling Height

For maximum comfort, fan should be installed approximately 8 ft from the floor.

Downrod Length		Ceiling Height	
1.83 m	72 in	16 ft	4.88 m
1.52 m	60 in	15 ft	4.57 m
1.22 m	48 in	14 ft	4.27 m
91.44 cm	36 in	13 ft	3.96 m
60.96 cm	24 in	12 ft	3.66 m
45.72 cm	18 in	11 ft	3.35 m
30.48 cm	12 in	10 ft	3.05 m

Compatible with any unthreaded 1.00 in dia downrod

Application



HELIUM

Transform smaller indoor spaces into havens of whisper-silent comfort and style.

Helium 24"

○ Matte White • ERTE1708065MWH



Easy Install / 30K / ABS Blades

Remote Control / AC Motor / Indoor Rated



Product Details

Airflow (CFM): 1471 (High) - 1016 (Low)

Fan Control: Remote Included

No. of speeds: 3 Speed

Light Type: Integrated LED

Lumens: 1959

LED Watts: 24W

CRI: 80

CCT: 30K

Indoor/Outdoor: Indoor Only

Motor Type : AC

Fan Size (in.)/Mounting Type: 24", Downrod, Flat or Angled ceiling (18° max)

Housing: Matte White

Blades: Non-reversible, Matte White

Lead Wire: 12" standard coming from motor with quick connector. Additional 54" extension lead wires with quick connectors included to allow for a 48" downrod (sold separately).

Distance from ceiling to bottom of the light kit once installed: 15"

Distance from Ceiling to bottom of blade once installed: 14"

Ceiling Fan Dimensions



Fan Size: 24" | Blade Pitch: 13.5° | Downrod Included: 6 in | Recommended Room Size: Up to 200 sq. ft

Recommended Downrod Length per Ceiling Height

For maximum comfort, fan should be installed approximately 8 ft from the floor.

Downrod Length		Ceiling Height	
1.83 m	72 in	16 ft	4.88 m
1.52 m	60 in	15 ft	4.57 m
1.22 m	48 in	14 ft	4.27 m
91.44 cm	36 in	13 ft	3.96 m
60.96 cm	24 in	12 ft	3.66 m
45.72 cm	18 in	11 ft	3.35 m
30.48 cm	12 in	10 ft	3.05 m

Compatible with any unthreaded 1.00 in dia downrod

Application



FARMDALE

Touch of contemporary elegance to your small spaces, the sleek and captivating caged fan.

Farmdale 24"

● **Matte Black** • ERTW1906626MBKCB



Easy Install / 27K / ABS Blades

Remote Control / AC Motor / Indoor Rated



Product Details

Airflow (CFM): 815 (High) - 625 (Low)

Fan Control: Remote Included

No. of speeds: 3 Speed

Light Type: 3 LED Edison Bulbs

Lumens: 500

LED Watts: 5.5W

CRI: 80

CCT: 27K

Indoor/Outdoor: Indoor Only

Motor Type / Size: AC / 156x8 | AC / 156x12

Fan Size (in.)/Mounting Type: 52", 24", Downrod, Flat or Angled ceiling (18° max)

Housing: Matte Black

Blades: Non-reversible, Matte Black

Lead Wire: 12" standard coming from motor with quick connector. Additional 54" extension lead wires with quick connectors included to allow for a 48" downrod (sold separately).

Distance from ceiling to bottom of the light kit once installed: 14.4"

Distance from Ceiling to bottom of blade once installed: 12.9"

Ceiling Fan Dimensions



Fan Size:	Blade Pitch:	Downrod Included:	Recommended Room Size:
24"	12°	6 in	Up to 200 sq. ft

Recommended Downrod Length per Ceiling Height

For maximum comfort, fan should be installed approximately 8 ft from the floor.

Downrod Length		Ceiling Height	
1.83 m	72 in	16 ft	4.88 m
1.52 m	60 in	15 ft	4.57 m
1.22 m	48 in	14 ft	4.27 m
91.44 cm	36 in	13 ft	3.96 m
60.96 cm	24 in	12 ft	3.66 m
45.72 cm	18 in	11 ft	3.35 m
30.48 cm	12 in	10 ft	3.05 m

Compatible with any unthreaded 1.00 in dia downrod

Application



MACEDONIA

Pinnacle of modern design and ultimate comfort in smaller living spaces for all-seasons bliss.

Macedonia 18"

Galvanized Antique White • ERTW2008603AWHGV

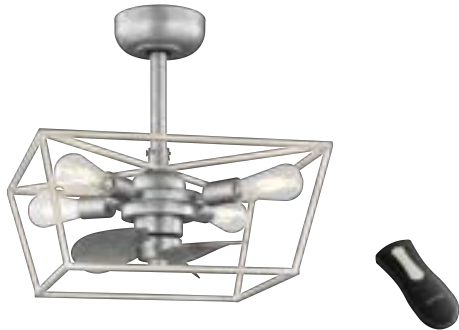

Easy Install / 27K / ABS Blades

Remote Control / AC Motor / Indoor Rated



Product Details

Airflow (CFM): 952 (High) - 677 (Low)

Fan Control: Remote Included

No. of speeds: 3 Speed

Light Type: 4 LED Edison Bulb

Lumens: 500

LED Watts: 5.5W

CRI: 80

CCT: 27K

Indoor/Outdoor: Indoor Only

Motor Type : AC

Fan Size (in./)Mounting Type: 18", Downrod, Flat or Angled ceiling (18° max)

Housing: Galvanized Antique White

Blades: Non-Reversible, Silver

Lead Wire: 12" standard coming from motor with quick connector. Additional 54" extension lead wires with quick connectors included to allow for a 48" downrod (sold separately).

Distance from ceiling to bottom of the light kit once installed: 14.4"

Distance from Ceiling to bottom of blade once installed: 12.9"

Ceiling Fan Dimensions



Fan Size: 18" | Blade Pitch: 12° | Downrod Included: 8 in | Recommended Room Size: Up to 200 sq. ft.

Recommended Downrod Length per Ceiling Height

For maximum comfort, fan should be installed approximately 8 ft from the floor.

Downrod Length		Ceiling Height	
1.83 m	72 in	16 ft	4.88 m
1.52 m	60 in	15 ft	4.57 m
1.22 m	48 in	14 ft	4.27 m
91.44 cm	36 in	13 ft	3.96 m
60.96 cm	24 in	12 ft	3.66 m
45.72 cm	18 in	11 ft	3.35 m
30.48 cm	12 in	10 ft	3.05 m

Compatible with any unthreaded 1.00 in dia downrod

Application

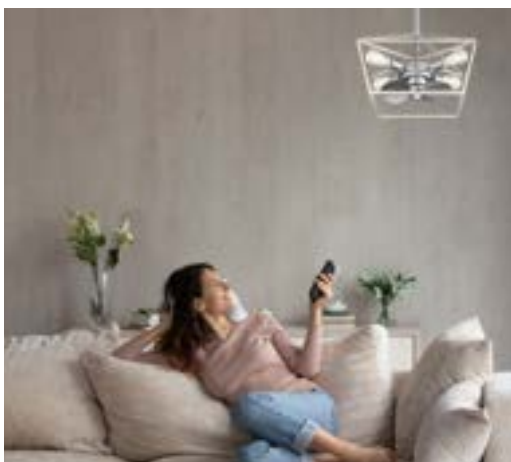

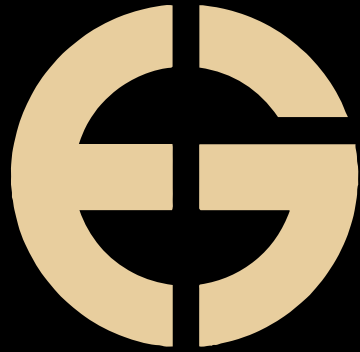

eran group.

(844) 411-5483 | erangroup.com

