

PROJECT NAME: \_\_\_\_\_ CAT. #: \_\_\_\_\_  
 NOTES: \_\_\_\_\_ FIXTURE SCHEDULE: \_\_\_\_\_

# WallMax Compact Open Face Series



29W-80W



120W

### Product Description

The WallMax Compact Open Face Wall Pack is a versatile low cost solution for general wall lighting applications. It features wattage and CCT selectability as well as an intergral photocell that can be turned on or off. The housing size covers existing HID footprints and has a battery backup option. You can also field install the c-Max receptacle (CEA Accessory) opening up the full range of c-Max field installable controls.

### Features:

- CCT selectable between 3000K, 4000K or 5000K
- Universal Voltage: 120-277V
- Wattage Selectable in 40W+ versions
- Battery Backup Options: -20°C
- Visors & Wire guards are available
- Photocell (On/Off) Standard
- CRI: ≥80
- Field installable c-Max receptacle (CEA Accessory) to allow c-Max Controls capability
- 6kV Surge Protection

### Construction:

- Rugged die cast housing with corrosion resistant polyester powder paint finish
- Impact resistant prismatic borosilicate glass
- 4 1/2 conduit holes, one on each side

### Ordering Structure

FAMILY	WATTAGE (NOMINAL)	VOLTAGE	-	CCT	COLOR	CONTROLS OPTIONS	EM OPTIONS
WCF= WallMax Open Face Wall Pack	29= 29W	U= Universal 120-277V	-	CS= 3/4/5K	B= Dark Bronze	PC= Photocell (On/Off switch) Standard	BLANK= No Battery E2= Battery Backup -20°C
	40= 40/35/28W 60= 60/50/40W 80= 80/70/60W 120= 120/100/80W			WCS= 3/4/5K, Wattage Selectable			







### Stocked Items

ORDER CODE	MODEL NUMBER	DLC PRODUCT ID	PRIMARY USE DESIGNATION	CLASSIFICATION
111241	WCF29U-CSBPC	S-ZRQ3Y4	Outdoor Non-Cutoff and Semi-Cutoff Wall-Mounted Area Luminaires	Premium 5.1
111059	WCF40U-WCSBPC	S-3SFTZ4		
111060	WCF60U-WCSBPC	S-0BKRJG		
111240	WCF80U-WCSBPC	S-6NXQTV		
111062	WCF120U-WCSBPC	S-4RK BVT		



## WallMax Compact Open Face Series

### Accessories

MODEL NUMBER	ORDER CODE	DESCRIPTION	IMAGE
WCF-VISOR-SMALL	111246	VISOR FOR WCF 29-80W	
WCF-VISOR-LARGE	111247	VISOR FOR WCF 120W	
WCF-WG-SMALL	111244	WIRE GUARD FOR WCF 29-80W	
WCF-WG-LARGE	111245	WIRE GUARD FOR WCF 120W	
CEA-RDB	107785	C-MAX EXTERNAL ADAPTOR BRONZE (WHITE ALSO AVAILABLE), MUST ALSO USE WCF-WTC-CEA-GASKET, <a href="#">ENABLES USE OF C-MAX ROUND CONTROL NODES</a>	
WCF-WTC-CEA-GASKET	111248	GASKET MUST BE USED WITH CEA-RDB	
EM2-REMOTE-MT	111294	FIELD INSTALLABLE REMOTE MOUNT - 20C BATTERY BACKUP (FOR UNIVERSAL (120-277V) PRODUCTS ONLY)	

### Specifications:

	WCF29	WCF40	WCF60	WCF80	WCF120
Nominal Wattage (W)	29	28/35/40	40/50/60	60/70/80	80/100/120
Output (lm) - Highest setting	4,460-4730	6,220-6,550	8,620-9,480	11,950-12,840	17,470-18,470
Output (lm) - Middle setting	N/A	5,080-5,530	7,000-7,900	10,080-11,200	14,000-15,300
Output (lm) - Low setting		4,460-4730	6,220-6,550	8,620-9,480	11,950-12,840
Efficacy (lm/W)	150-159	145-158	140-158	140-160	140-153
CCT	Selectable between 3/4/5K				
CRI	>80				
Dimming	0-10V				
Power Factor	≥.90				
Input Voltage	120-277V				
Surge Protection	6kV				
Equivalency	150W	175W	250W	300/320W	400W
Lumen Maintenance (L70)	>100,000 hrs				
Operating Temperature	-40°F to 122°F (-40°C to 50°C)				
Housing	Die cast aluminum with corrosion resistant polyester powder paint finish				
Lens	Impact resistant prismatic borrosilicate glass				
Listings	UL, FCC, DLC 5.1 Premium				
Environment	Wet Locations and IP65				
Warranty	5 Year warranty. Check <a href="http://maxlite.com/warranties">maxlite.com/warranties</a> for details.				

\* Default setting is highest wattage and 5000K CCT.

# WallMax Compact Open Face Series

## Dimensions

### ISOFOOTCANDLE:

Each gridline represents one mounting height.  
 For mounting heights other than noted multiply FC by the below factor.

$$\text{Factor} = \frac{(\text{Chart's Mtg Height})^2}{(\text{Actual Mtg Height})^2}$$

### LEGEND

- 0.5 fc
- 1 fc
- 2 fc
- 5 fc

Layouts based on 3000K. Results are 3-5% more for 4000/5000K. Consult IES file for more precise calculations.

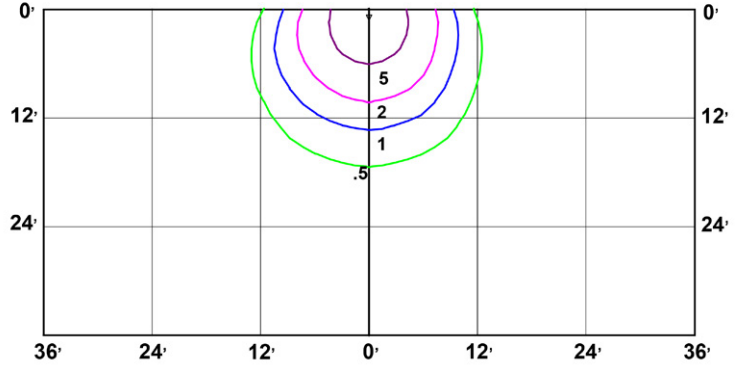

29W fc at 12' mtg height

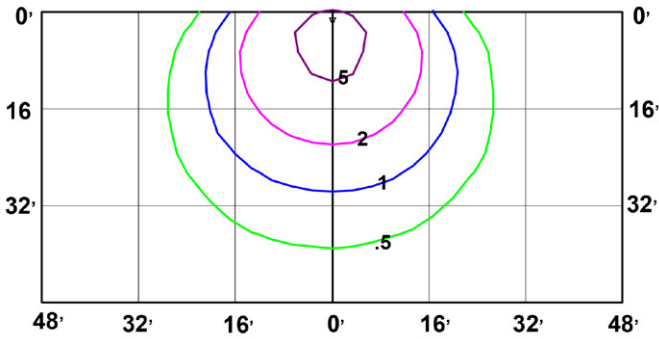

40W fc at 16' mtg height

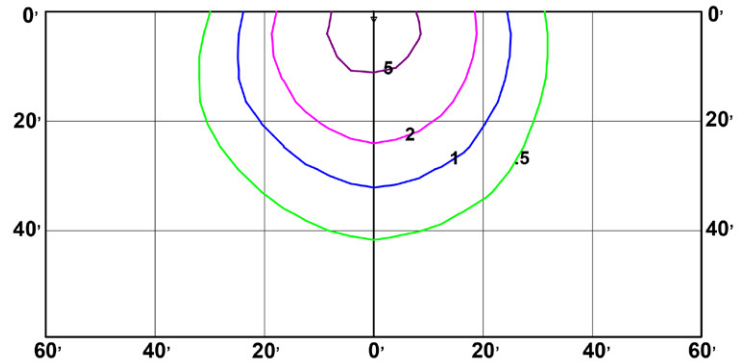

60W fc at 20' mtg height

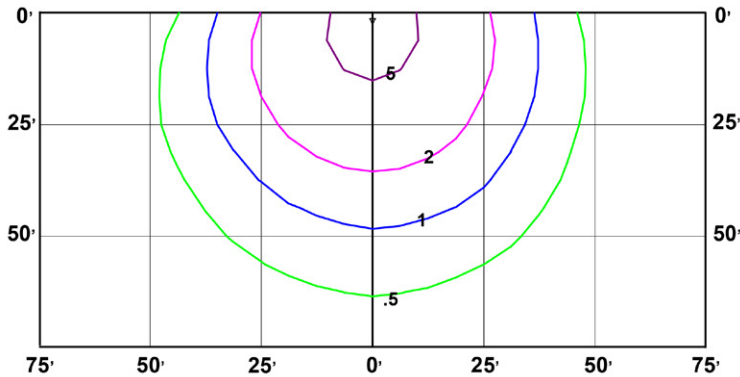

80W fc at 25' mtg height

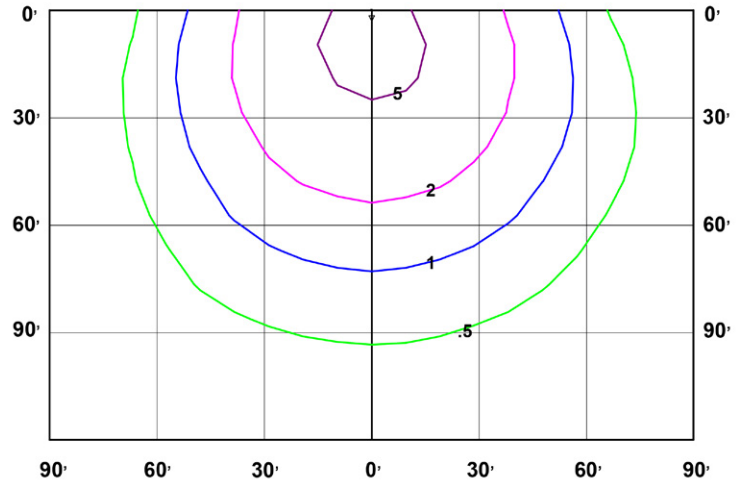

120W fc at 30' mtg height

# WallMax Compact Open Face Series

## Dimensions

### 29W-80W

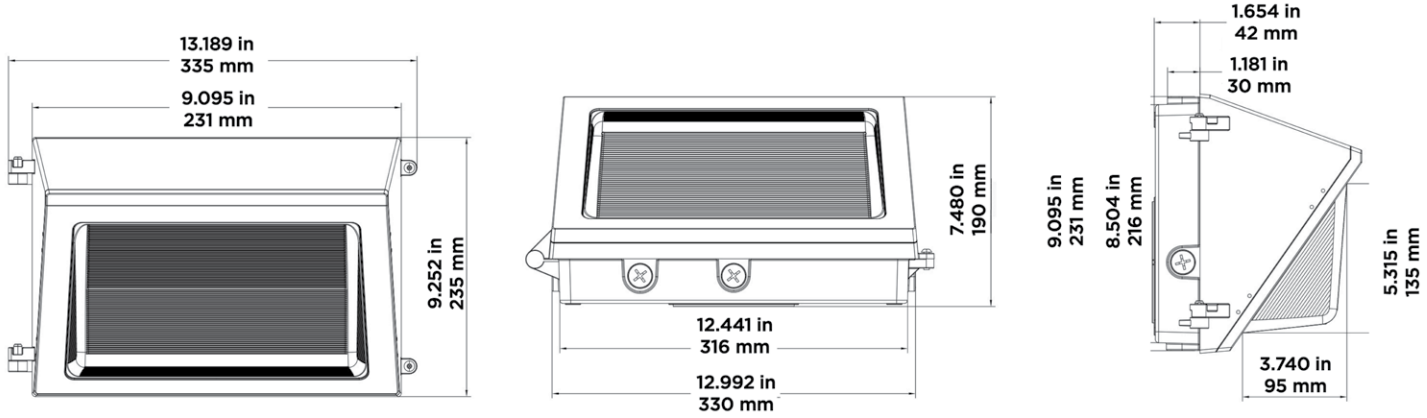

### 120W

